

OLYMPUS®

DIGITAL CAMERA

E-M5

Instruction Manual

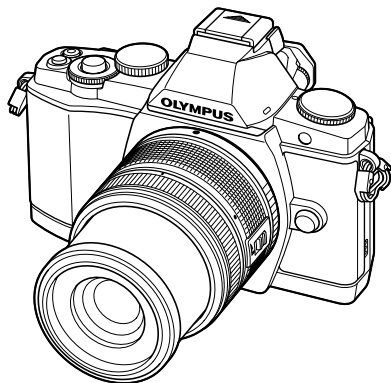

Basic guide

Quick task index

Table of Contents

1. **Basic photography/frequently-used options**
2. **Other shooting options**
3. **Flash shooting**
4. **Shooting and viewing movies**
5. **Playback options**
6. **Sending and receiving images**
7. **Using OLYMPUS Viewer 2**
8. **Printing pictures**
9. **Camera setup**
10. **Customizing camera settings**
11. **Information**
12. **SAFETY PRECAUTIONS**

System chart

Index

- Thank you for purchasing an Olympus digital camera. Before you start to use your new camera, please read these instructions carefully to enjoy optimum performance and a longer service life. Keep this manual in a safe place for future reference.
- We recommend that you take test shots to get accustomed to your camera before taking important photographs.
- The screen and camera illustrations shown in this manual were produced during the development stages and may differ from the actual product.
- The contents in this manual are based on firmware version 1.0 for this camera. If there are additions and/or modifications of functions due to firmware update for the camera, the contents will differ. For the latest information, please visit the Olympus website.

■ This notice concerns the supplied flash unit and is chiefly directed to users in North America.

Information for Your Safety

IMPORTANT SAFETY INSTRUCTIONS





When using your photographic equipment, basic safety precautions should always be followed, including the following:

- Read and understand all instructions before using.
- Close supervision is necessary when any flash is used by or near children. Do not leave flash unattended while in use.
- Care must be taken as burns can occur from touching hot parts.
- Do not operate if the flash has been dropped or damaged - until it has been examined by qualified service personnel.
- Let flash cool completely before putting away.
- To reduce the risk of electric shock, do not immerse this flash in water or other liquids.
- To reduce the risk of electric shock, do not disassemble this flash, but take it to qualified service personnel when service or repair work is required. Incorrect reassembly can cause electric shock when the flash is used subsequently.
- The use of an accessory attachment not recommended by the manufacturer may cause a risk of fire, electric shock, or injury to persons.

SAVE THESE INSTRUCTIONS

Indications used in this manual

The following symbols are used throughout this manual.

 Cautions	Important information on factors which may lead to a malfunction or operational problems. Also warns of operations that should be absolutely avoided.
 Notes	Points to note when using the camera.
 Tips	Useful information and hints that will help you get the most out of your camera.
	Reference pages describing details or related information.

Unpack the box contents

The following items are included with the camera.
If anything is missing or damaged, contact the dealer from whom you purchased the camera.



Camera



Body cap



Strap

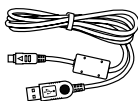

USB cable
CB-USB6



AV cable
(Monaural)
CB-AVC3

- Flash case
- Computer software CD-ROM
- Instruction manual
- Warranty card



Flash
FL-LM2



Lithium ion
battery
BLN-1

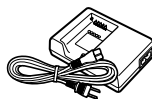

Lithium ion
charger
BCN-1

Attaching the strap

- 1 Thread the strap in the direction of the arrows.

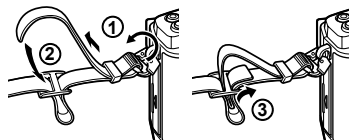

- 2 Lastly, pull the strap tight making sure that it is fastened securely.

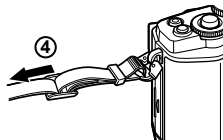

- Attach the other end of the strap to the other eyelet in the same way.

Charging and inserting the battery

1 Charging the battery.

Charging indicator

Charging in progress	Lights orange
Charging complete	Off
Charging error	Blinks orange

(Charging time: Up to approximately 4 hours)

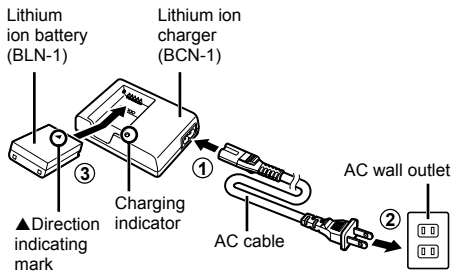

⚠ Cautions

- Unplug the charger when charging is complete.

2 Loading the battery.

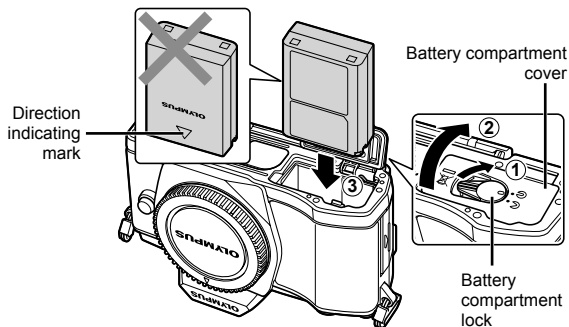

3 Closing the battery compartment cover.

Removing the battery

Turn off the camera before opening or closing the battery compartment cover.

To remove the battery, first push the battery lock knob in the direction of the arrow and then remove.

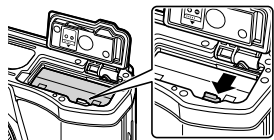

⚠ Cautions

- Contact an authorized distributor or service center if you are unable to remove the battery. Do not use force.

📌 Notes

- It is recommended to set aside a backup battery for prolonged shooting in case the battery in use drains.

Inserting and removing cards

1 Loading the card.

- Open the card slot cover.
- Slide the card in until it is locked into place.
👉 "Card basics" (P. 103)

! Cautions

- Turn off the camera before loading or removing the card.

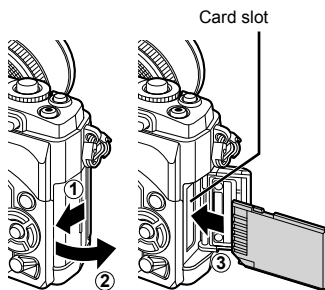

2 Closing the card slot cover.

- Close the cover until you hear a click.

! Cautions

- Be sure the card slot cover is closed before using the camera.

Removing the card

Press the inserted card lightly and it will be ejected. Pull out the card.

! Cautions

- Do not remove the battery or card while the card write indicator (P. 31) is displayed.

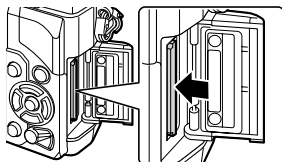

Eye-Fi Cards

- Use the Eye-Fi card in compliance with the laws and regulations of the country where the camera is used.
- Remove the Eye-Fi card from the camera or select [Off] for [Eye-Fi] (P. 93) in airplanes and other locations in which use is prohibited.
- Eye-Fi cards may become hot during use.
- The drain on the battery may increase when Eye-Fi cards are used.
- Camera response may slow when Eye-Fi cards are used.

Attaching a lens to the camera

1 Attach a lens to the camera.

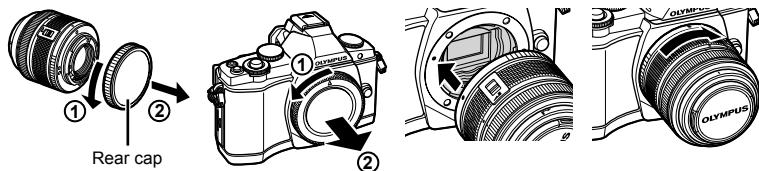

- Align the lens attachment mark (red) on the camera with the alignment mark (red) on the lens, then insert the lens into the camera's body.
- Rotate the lens in the direction indicated by the arrow until you hear it click.

⚠ Cautions

- Make sure the camera is turned off.
- Do not press the lens release button.
- Do not touch internal portions of the camera.

2 Remove the lens cap.

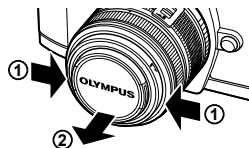

Using lenses with an UNLOCK switch

Retractable lenses with an UNLOCK switch can not be used while retracted.

Turn the zoom ring in the direction of arrow (1) to extend the lens (2).

To store, turn the zoom ring in the direction of arrow (4) while sliding the UNLOCK switch (3).

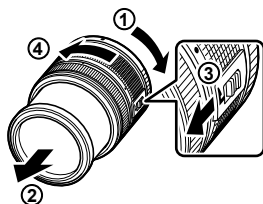

Removing the lens from the camera

While pressing the lens release button, rotate the lens in the direction of the arrow.

👉 "Interchangeable lenses" (P. 104)

Lens release button

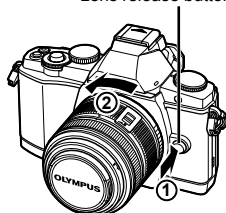

Attaching the flash unit

- 1 Remove the terminal cover from the flash unit and attach the flash to the camera.

- Slide the flash unit all the way in, stopping when it contacts the back of the shoe and is securely in place.

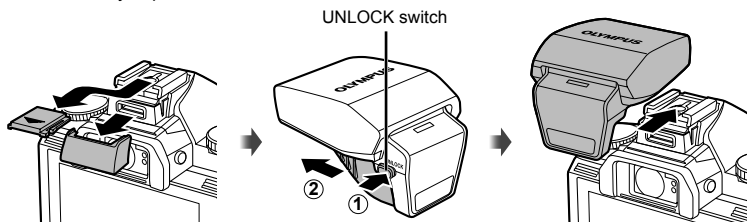

- 2 To use the flash, raise the flash head.

- Lower the flash head when the flash is not in use.

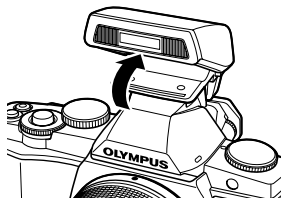

Removing the Flash Unit

Press the UNLOCK switch while removing the flash unit.

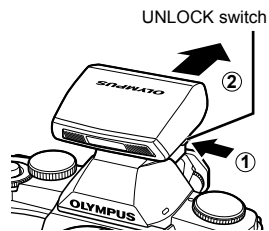

Power on

- 1 Rotate the **ON/OFF** switch to the ON position to turn the camera on.
 - When the camera is turned on, the monitor will turn on.
 - To turn the camera off, rotate the **ON/OFF** switch to OFF.
- 2 Set the mode dial to **TAUTO**.

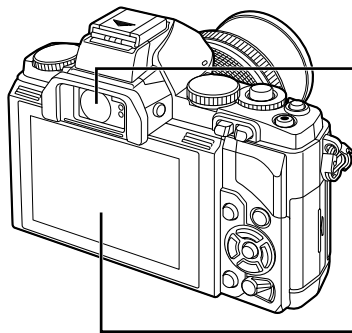

Viewfinder (P. 30)

The viewfinder turns on and the monitor turns off automatically when you put your eye to the viewfinder.



Monitor

The super control panel (P. 22) will be displayed.

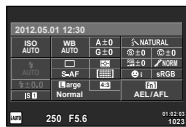

Adjusting Viewfinder Focus

Look through the viewfinder and rotate the dial until the display is in sharp focus.

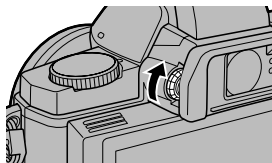

Using the Monitor

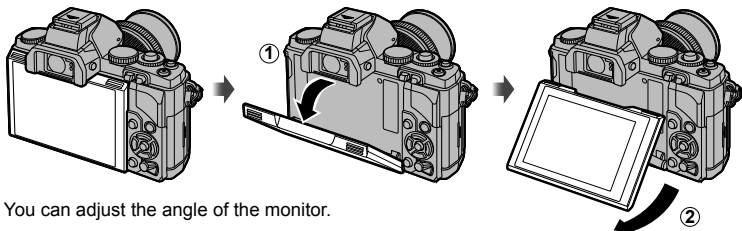

You can adjust the angle of the monitor.

Setting the date/time

Date and time information is recorded on the card together with the images. The file name is also included with the date and time information. Be sure to set the correct date and time before using the camera.

1 Display the menus.

- Press the **MENU** button to display the menus.

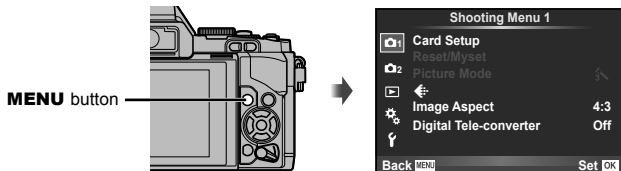

2 Select [f] in the [f] (setup) tab.

- Use Δ ∇ to select [f] and press \triangleright .
- Select [f] and press \triangleright .

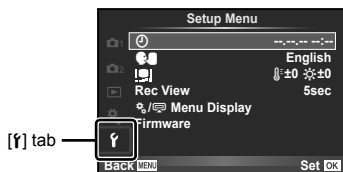

3 Set the date and time.

- Use \triangleleft \triangleright to select items.
- Use Δ ∇ to change the selected item.
- Use Δ ∇ to select the date format.

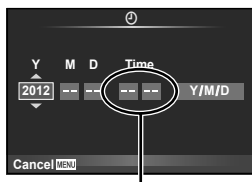

The time is displayed using a 24-hour clock.

4 Save settings and exit.

- Press \odot to set the camera clock and exit to the main menu.
- Press the **MENU** button to exit the menus.

Names of parts

Camera

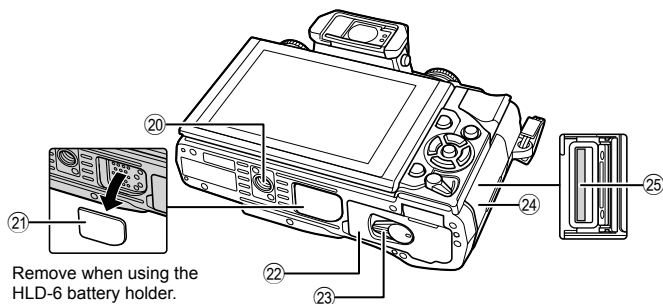
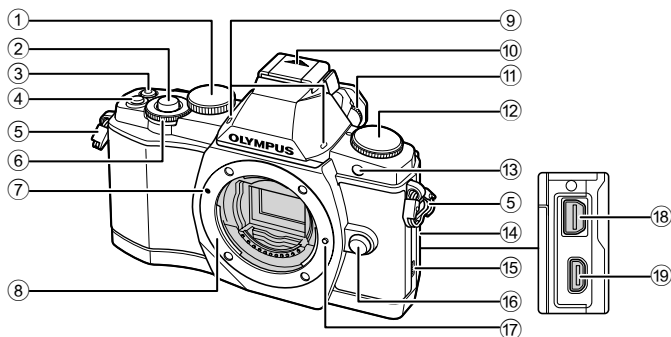

- | | |
|--|---|
| ① Main dial* (☺).....P. 16, 57–59 | ⑭ Connector cover |
| ② Shutter button.....P. 13, 14, 44, 96 | ⑮ Speaker |
| ③ (Movie) button....P. 13, 15, 67, 69, 93 | ⑯ Lens release button.....P. 6 |
| ④ Fn2 button.....P. 25, 69, 93 | ⑰ Lens lock pin |
| ⑤ Strap eyelet.....P. 3 | ⑱ Multi-connector.....P. 74, 78, 82 |
| ⑥ Sub dial* ().....P. 16, 57–59 | ⑲ HDMI micro connector (type D).....P. 74 |
| ⑦ Lens attachment mark.....P. 6 | ⑳ Tripod socket |
| ⑧ Mount (Remove the body cap before attaching the lens.) | ㉑ PBH cover |
| ⑨ Stereo microphone.....P. 68, 73 | ㉒ Battery compartment cover.....P. 4 |
| ⑩ Hot shoe cover | ㉓ Battery compartment lock.....P. 4 |
| ⑪ Diopter adjustment dial.....P. 8 | ㉔ Card slot cover.....P. 5 |
| ⑫ Mode dial.....P. 8, 12 | ㉕ Card slot.....P. 5 |
| ⑬ Self-timer lamp/
AF illuminator.....P. 56 | |

* In this manual, the and icons represent operations performed using the main and sub dials.

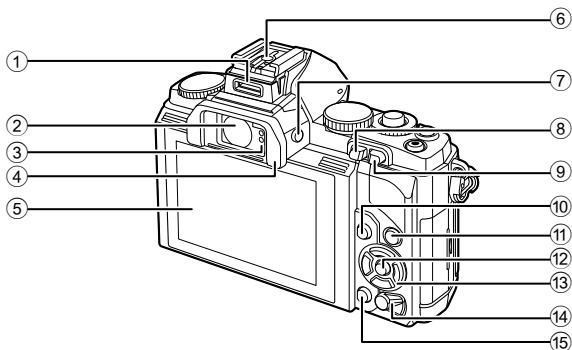

- | | |
|---|---|
| ① Accessory port.....P. 76 | ⑨ Fn1 buttonP. 69, 93 |
| ② ViewfinderP. 8, 30 | ⑩ MENU button.....P. 26 |
| ③ Eye sensor | ⑪ INFO (Information display) button
.....P. 39–41, 69 |
| ④ Eyecup | ⑫ [OK] buttonP. 23, 24, 26 |
| ⑤ Monitor (Touch screen).....P. 27, 31, 32 | ⑬ Arrow pad (▲ ▼ ◀ ▶) |
| ⑥ Hot shoe | ⑭ ON/OFF switch.....P. 8 |
| ⑦ [OK] (LV) buttonP. 15, 92 | ⑮ [Erase] buttonP. 17, 69 |
| ⑧ [Play] (Playback) button.....P. 16, 69 | |

Camera controls

Mode dial

Use the mode dial to select the shooting mode. After choosing the shooting mode, use the shutter button to take photographs and the **Q** button to shoot movies.

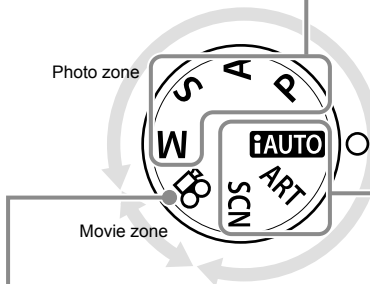
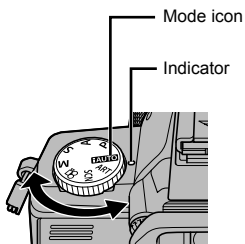

■ Advanced shooting modes

P	Program shooting (P. 57)
A	Aperture priority shooting (P. 57)
S	Shutter priority shooting (P. 58)
M	Manual shooting (P. 58)

- The settings made in the advanced shooting modes are retained even if the camera is turned off.

■ Easy shooting modes

iAUTO	iAUTO (P. 21)
ART	Art filter (P. 18)
SCN	Scene (P. 19)

- When rotating the mode dial or turning off the power in the easy shooting modes, functions with changes made to their settings are restored to the factory default settings.

■ Movie mode

	Movie (P. 67)
--	---------------





Tips

Resetting camera settings. "Restoring default or custom settings" (P. 42)

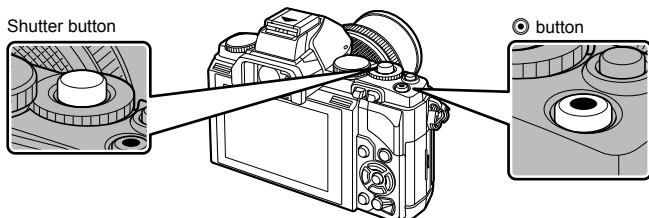
The Shutter and Buttons

Use the shutter button to take photographs and the  button record movies.



Mode	Photos: shutter button	Movies:  button
P	Aperture and shutter speed are automatically adjusted for optimal results.	The camera automatically adjusts settings and records a movie.
A	You control aperture.	
S	You control shutter speed.	
M	You control aperture and shutter speed.	
 AUTO	A full auto mode in which the camera automatically optimizes settings for the current scene.	
ART	Select an art filter.	
SCN	Select a scene.	
	Photographs are recorded at the settings selected in  Mode].	Shoot movies using shutter speed and aperture effects and movie special effects.

■ Taking photographs during movie recording

- To take a photograph during movie recording, press the shutter button. Press the  button to end recording. Three files will be recorded to the memory card: the movie footage preceding the photograph, the photograph itself, and the movie footage following the photograph.
- Only one photograph can be taken at a time during movie recording; the self-timer and flash can not be used.

Cautions

- Image size and quality for photographs are independent of movie frame size.
- The autofocus and metering used in movie mode may differ from that used to take photographs.
- The  button can not be used to record movies in the following instances: shutter button pressed halfway/during bulb or time photography/Sequential shooting/PANORAMA/3D/multiple exposure, etc. (still photography also ends)

Taking photographs/shooting movies

1 Frame a picture in the viewfinder.

- The monitor turns off and the display in the viewfinder lights up.
- Be careful that your fingers or the camera strap do not obstruct the lens.

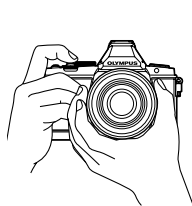

Horizontal grip

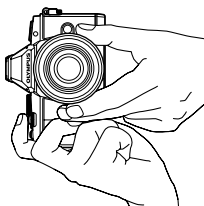

Vertical grip

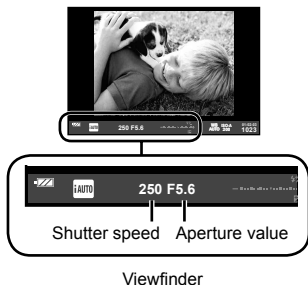

2 Adjust the focus.

- Lightly press the shutter button down to the first position (press the shutter button halfway).

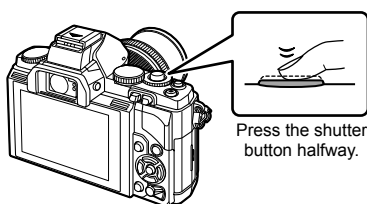

AF confirmation mark

AF target



- The AF confirmation mark (● or ○) will be displayed and focus will lock.

●	Lenses that supports Hi-Speed Imager AF*
○	Lenses with other Four Thirds mounts

* Visit our website for more information.

- The shutter speed and aperture value that have been set automatically by the camera are displayed.
- If the in-focus indicator blinks, the subject is not in focus. (P. 98)

Pressing the shutter button halfway and all the way down

The shutter button has two positions. The act of lightly pressing the shutter button to the first position and holding it there is called “pressing the shutter button halfway,” that of pressing it all the way down to the second to the position “pressing the shutter button all (or the rest of) the way down.”



3 Release the shutter.

Taking photographs

Press the shutter button all the way (fully).

- The shutter sounds and the picture is taken.



Recording movies

Release the shutter button and press the  button to begin recording.

Press the  button again to end recording.





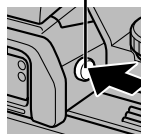

■ Framing subjects in the monitor

Press the  button to display the subject in the monitor. Press the  button again to switch back to the original display.

 button





Notes

- The camera can be configured to switch between the viewfinder and monitor displays either automatically or manually. Press and hold the  button until the automatic display toggle menu is displayed and select an option using  . Pressing the  button toggles between the monitor and viewfinder displays.
- If no operations are performed for a minute, the camera enters “sleep” (stand-by) mode to turn off the monitor and to cancel all actions. The camera activates again when you touch any button (the shutter button,  button, etc.). The camera will turn off automatically if left in sleep mode for 4 hours. Turn the camera on again before use.
- Automatic display selection is not available in the following instances.
 - 3D photography/During live bulb photography

Cautions

- If the camera is used for extended periods, the temperature of the image pickup device will rise and noise and colored fog may appear in images recorded at high ISO sensitivities. Choose a lower ISO sensitivity or turn the camera off for a short period.





Tips

Changing the delay before the camera enters sleep mode.  [Sleep] (P. 88)
 Choosing a viewfinder display style.  [Built-in EVF Style] (P. 92)

Viewing Images

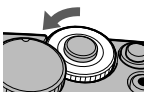
■ Single-frame playback

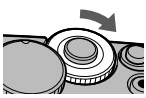
- Press the  button to display your most recent photograph or movie.
- Use the sub dial or arrow pad to view other pictures.

	Sub dial	Arrow pad
Displays the previous frame		
Displays the next frame		





Still image





Movie

■ Close-up playback

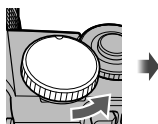
Rotate the main dial to  to zoom in on a picture in single-image playback, or to  to display the image full frame.



■ Index display/Calendar display

- When the image is displayed full frame, rotating the main dial to  displays thumbnail images. Rotating the dial multiple times brings you to calendar playback.
- Rotate the main dial to  to return to full-frame playback.





Index display



Calendar display

■ Movie playback

Select a movie and press  to display the playback menu. Select [Movie Play] and press  to begin playback. To interrupt movie playback, press **MENU**.



Volume

Volume can be adjusted by pressing Δ or ∇ during single-frame and movie playback.



Erasing images

Display an image you want to delete and press Eraser . Select [Yes] and press OK . You can also select multiple images for deletion.

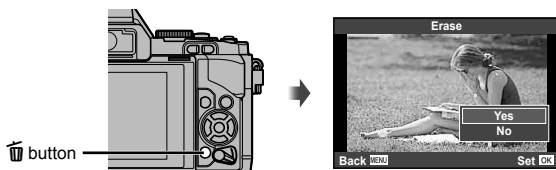

Protecting images

Protect images from accidental deletion. Display an image you wish to protect and press the **Fn2** button; a Protect (protect) icon will appear on the image. Press the **Fn2** button again to remove protection. You can also protect multiple selected images.



! Cautions

- Formatting the card erases all images even if they have been protected.

Using art filters

1 Rotate the mode dial to **ART**.

- A menu of art filters will be displayed. Select a filter using Δ ∇ .
- Press \odot or press the shutter button halfway to select the highlighted item and exit the art filter menu.



■ Types of art filters

- | | |
|------------------|--------------------------|
| Pop Art | Diorama |
| Soft Focus | Cross Process |
| Pale&Light Color | Gentle Sepia |
| Light Tone | Dramatic Tone |
| Grainy Film | Key Line |
| Pin Hole | ART BKT (ART bracketing) |

2 Shoot.

- To choose a different setting, press \odot to display the art filter menu.

ART bracketing

Each time the shutter is released, the camera creates copies for all art filters. Use the $\left[\text{ART} \right] \rightarrow$ option to choose filters.

Art effects

Art filters can be modified and effects can be added. Pressing \triangleright in the art filter menu displays additional options.

Modifying filters

Option I is the original filter, while options II and on add effects that modify the original filter.

Adding effects*

Soft focus, pin-hole, frames, white edges, starlight

* The effects available vary with the selected filter.

! Cautions

- If [RAW] is currently selected for image quality, image quality will automatically be set to [I/N+RAW]. The art filter will be applied to the JPEG copy only.
- Depending on the subject, tone transitions may be ragged, the effect may be less noticeable, or the image may become more “grainy.”
- Some effects may not be visible in live view or during movie recording.
- Playback may differ according to the filters, effects, or movie quality settings applied.

Shooting in scene mode

1 Rotate the mode dial to **SCN**.

- A menu of scene menu will be displayed. Select a scene using Δ / ∇ .
- Press OK or press the shutter button halfway to select the highlighted option and exit the scene menu.



■ Types of scene modes

- | | |
|--------------------|------------------|
| Portrait | Nature Macro |
| e-Portrait | Candle |
| Landscape | Sunset |
| Landscape+Portrait | Documents |
| Sport | Panorama (P. 60) |
| Night Scene | Fireworks |
| Night+Portrait | Beach & Snow |
| Children | Fisheye Effect |
| High Key | Wide-angle |
| Low Key | Macro |
| DIS Mode | 3D Photo (P. 61) |
| Macro | |

2 Shoot.

- To choose a different setting, press OK to display the scene menu.

! Cautions

- In [e-Portrait] mode, two images are recorded: an unmodified image and a second image to which [e-Portrait] effects have been applied. The unmodified image is recorded using the option currently selected for image quality, the modified copy at an image quality of JPEG (M-quality (2560 × 1920)).
- [Fisheye Effect], [Wide-angle], and [Macro] are for use with optional converter lenses.
- Movies can not be recorded in [e-Portrait], [Panorama], or [3D Photo] mode.

Using Movie Mode (📹)

Movie mode (📹) can be used to film movies with special effects.

- 1 Rotate the mode dial to 📹.

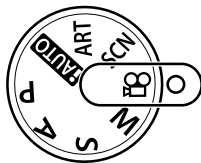

- 2 Press ▽ or ▷.

▽	Multi Echo	Apply an after-image effect. After-images will appear behind moving objects.
▷	One Shot Echo	An after-image will appear for a short time after you press the button. The after-image will disappear automatically after a while.

- Movie effects will be displayed in the monitor.
- Pressing the button again when [Multi Echo] is selected cancels the effect. If [One Shot Echo] is selected, the effect is updated each time the button is pressed.

- 3 Press the shutter button to start recording.

- Press ▽ or ▷ to enable or disable movie effects during recording.

! Cautions

- The frame rate will drop slightly during recording.
- The 2 effects can not be applied simultaneously.
- Use a memory card with an SD speed class of 6 or better. Movie recording may end unexpectedly if a slower card is used.
- Taking a photograph during movie recording cancels the effect; the effect does not appear in the photograph.

Using live guides

Live guides are available in iAUTO (iAUTO) mode. While iAUTO is a full auto mode, live guides make it easy to access a variety of advanced photographic techniques.

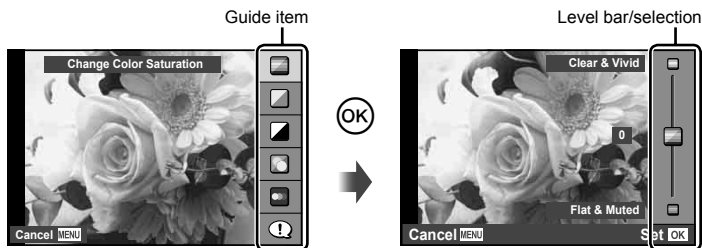

- 1 Set the mode dial to **iAUTO**.
- 2 After pressing **OK** to display the live guide, use the **Δ**/**∇** buttons on the arrow pad to highlight an item and press **OK** to select.
- 3 Use **Δ**/**∇** on the arrow pad to choose the level.
 - If [Shooting Tips] is selected, highlight an item and press **OK** to view a description.
 - Press the shutter button halfway to select.
 - The effect of the selected level is visible in the display. If [Blur Background] or [Express Motions] is selected, the display will return to normal, but the selected effect will be visible in the final photograph.
- 4 Shoot.
 - Press the shutter button to shoot.
 - To clear the live guide from the display, press the **MENU** button.

! Cautions

- If [RAW] is currently selected for image quality, image quality will automatically be set to [L/N+RAW].
- Live guide settings are not applied to the RAW copy.
- Pictures may appear grainy at some live guide setting levels.
- Changes to live guide setting levels may not be visible in the monitor.
- Frame rates drop when [Blurred Motion] is selected.
- The flash can not be used with the live guide.
- Changes to live guide options cancel previous changes.
- Choosing live guide settings that exceed the limits of the camera exposure meters may result in pictures that are over- or under-exposed.

Using the super control panel

The super control panel lists shooting options and their status. The LV super control panel is displayed when the monitor is used to frame pictures.

Super control panel

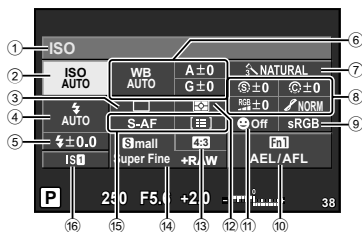

■ Settings that can be modified using super control panel

①	Currently selected option	B&W Filter (F)	P. 53
②	ISO sensitivity P. 55	Picture tone (T)	P. 53
③	Sequential shooting/self-timer P. 56	⑨	Color space P. 90
④	Flash mode P. 65	⑩	Button assignment P. 93
⑤	Flash intensity control P. 66	⑪	Face priority P. 46, 86
⑥	White balance P. 50	⑫	Metering mode P. 48
	White balance compensation P. 50	⑬	Aspect ratio P. 55
⑦	Picture mode P. 52	⑭	Record mode P. 54
⑧	Sharpness (S) P. 53	⑮	AF mode P. 43
	Contrast (C) P. 53		AF target P. 44
	Saturation (RGB) P. 53	⑯	Image stabilizer P. 49
	Gradation (S) P. 53		

⚠ Cautions

- Not displayed in movie record mode.

■ Framing pictures in the viewfinder

When the viewfinder is used to frame photographs, the super control panel will be displayed in the monitor. The panel can be hidden or displayed by pressing the **INFO** button.

- 1 Press **OK**.
- 2 Highlight items with $\Delta \nabla \triangleleft \triangleright$ or the main dial and use the sub dial to choose an option.

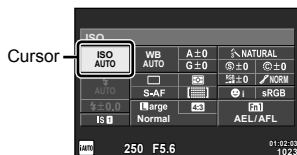

- To choose an option from a menu, highlight the item and press **OK**.

■ Framing pictures in the monitor

When pictures are framed in the monitor, settings can be adjusted using the live control (P. 24) or LV super control panel. Before using the LV super control panel, select [On] for [Control Settings] (P. 87) > [Live SCP].

- 1 Press **OK**.
 - The live control will be displayed.



- 2 Press the **INFO** button to display the LV super control panel.



- 3 Use $\Delta \nabla \triangleleft \triangleright$ to highlight the desired item and use the dial to choose an option.
 - To choose an option from a menu, highlight the item and press **OK**.



Using live control

The live control is used to adjust settings when pictures are framed in the monitor. The effects can be viewed in the monitor. In modes other than **P/S/A/M/G**, you will need to adjust settings in the custom menu (P. 86) before using the live control.



■ Available settings

Image stabilizer	P. 49	Record mode	P. 54
Picture mode	P. 52	Flash mode.....	P. 65
Scene mode	P. 19	Flash intensity control.....	P. 66
Art filter mode	P. 18	Metering mode.....	P. 48
mode	P. 67	AF mode	P. 43
White balance.....	P. 50	ISO sensitivity.....	P. 55
Sequential shooting/self-timer	P. 56	Face priority.....	P. 46
Aspect ratio.....	P. 55	Movie sound record.....	P. 67

1 Press to display the live control.

- To hide the live control, press again.

2 Highlight items with , then use or the sub dial to highlight an option and press .

- The selected settings take effect automatically if no operations are performed for about 8 seconds.

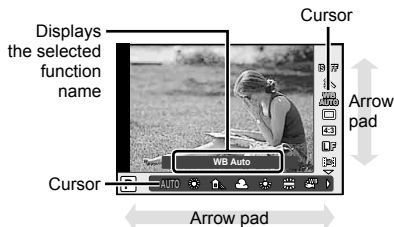

Cautions

- Some items are not available in some shooting modes.

Tips

For information on displaying or hiding the live control. [Control Settings] (P. 87)

Using the Multi-Function Button

When framing pictures in the viewfinder, you can adjust settings quickly using the multi-function button. At default settings, the **Fn2** button is assigned the role of the multi-function button.

■ Choosing a function

- 1 Press and hold the **Fn2** button and rotate the dial.
 - The menus are displayed.
- 2 Keep rotating the dial to select the desired function.
 - Release the button when the desired function is selected.

■ Using multifunction options

Press the **Fn2** button. An option selection dialog will be displayed.

[Q] assigned to Fn2 button

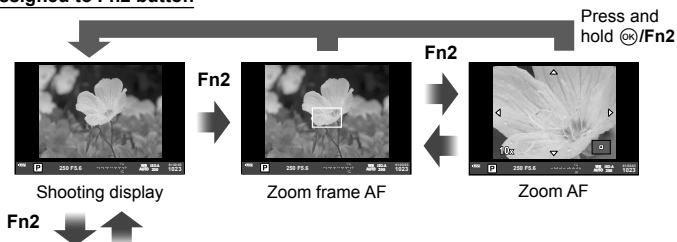

Other option assigned to Fn2 button



Function	Main dial (☺)	Sub dial (☻)
Highlight and shadow control (P. 47)	Decrease	Increase
White balance	Select an option	
Q (Zoom frame AF/zoom AF) (P. 45)	Zoom frame AF: Exposure compensation Zoom AF: Zoom in or out	
Aspect ratio selection (P. 55)	Select an option	

Using the menus

- 1 Press the **MENU** button to display the menus.

Menus

- 1 Preliminary and basic shooting options
- 2 Advanced shooting options
- ▶ Playback and retouch options
- ⚙ Custom menu
- 🔌 Accessory port menu*
- ƒ Camera setup (e.g., date and language)

* Not displayed at default settings.

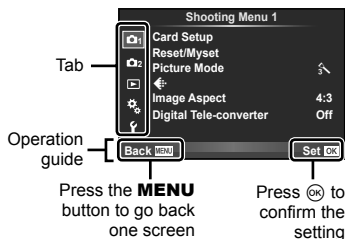

- 2 Use Δ ∇ to select a tab and press **OK**.
- 3 Select an item using Δ ∇ and press **OK** to display options for the selected item.

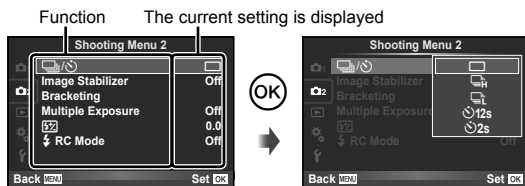

- 4 Use Δ ∇ to highlight an option and press **OK** to select.
 - Press the **MENU** button repeatedly to exit the menu.

Notes

- For details on the functions that can be set with the menu, refer to "Menu directory" (P. 111).
- A guide is displayed for about 2 seconds after you select an option. Press the **INFO** button to view or hide guides.

Tips

- Camera settings can be customized to your shooting style: Use the custom menus to customize camera settings to your own goals or taste. "Customizing camera settings" (P. 86)
- Using accessory port devices: Settings for the EVF and OLYMPUS PENPAL accessories are accessed from the accessory port menu. This menu is not displayed by default, and you will need to display it before proceeding. "Customizing camera settings" (P. 86)

Using the Touch screen

Use the touch screen during playback or when framing pictures in the monitor. You can also use the touch screen to adjust settings in the super control and LV super control panels.

Live Guides

The touch screen can be used with live guides.

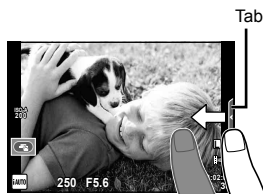

- 1 Touch the tab and swipe your finger to the left to display live guides.
 - Tap to select items.
- 2 Use your finger to position the sliders.
 - Press the **MENU** button to exit the live guide display.



Shooting Mode

You can focus and shoot by tapping the monitor.

Tap  to cycle through touch screen settings.

- | | |
|---|---|
|  | Touch screen operations disabled. |
|  | Tap a subject to focus and automatically release the shutter. |
|  | Tap to display a focus frame and focus on the subject in the selected area. You can use the touch screen to choose the position and size of the focus frame. Photographs can be taken by pressing the shutter button. |

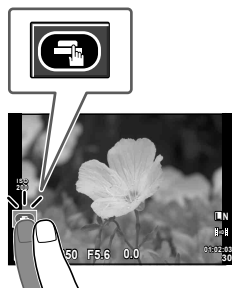

■ Previewing Your Subject ()

- 1 Tap the subject in the display.
 - An AF frame will be displayed.
 - Use the slider to choose the size of the frame.
- 2 Next, tap  to zoom in on the subject in the focus frame.
 - Use your finger to scroll the display.

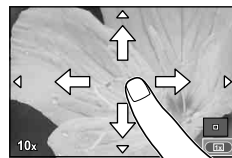
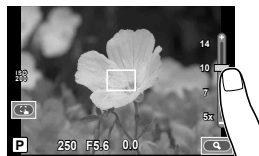

Playback Mode

Use the touch screen to page through images or zoom in and out.

■ Full-Frame Playback

Viewing Additional Images

- Slide your finger to the left to view later frames, right to scroll view earlier frames.
- Keep your finger on the edges of the display to scroll continuously backward or forward through pictures.

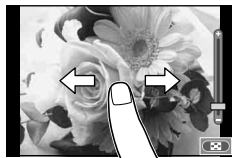

Playback Zoom

- Slide the bar up or down to zoom in or out.
- Use your finger to scroll the display when the picture is zoomed in.
- Tap to display Index playback. For calendar playback, tap until the calendar is displayed.



■ Index/Calendar Playback

Page Ahead/Page Back

- Slide your finger up to view the next page, down to view the previous page.
- Use or to choose the number of images displayed.
- For single-frame playback, tap until the current image is displayed full frame.

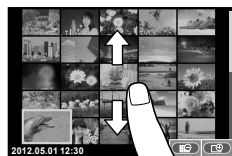

Viewing Images

- Tap an image to view it full frame.

Adjusting Settings

Settings can be adjusted in the super control and LV super control panels.

1 Display the super control panel.

- Press to display the cursor.



2 Tap the desired item.

- The item will be highlighted.



3 Rotate the dial to choose an option.

! Cautions

- The situations in which touch screen operations are not available include the following.
Movie recording/panorama/3D/e-portrait/multiple exposure/during bulb or time photography/one-touch white balance dialog/when buttons or dials are in use
- In self-timer mode, the timer can be started by tapping the display. Tap again to stop the timer.
- Do not touch the display with your fingernails or other sharp objects.
- Gloves or monitor covers may interfere with touch screen operation.



Tips

Disabling the touch screen.  [Touch Screen Settings] (P. 93)

Information displayed in the monitor

Shooting

■ Framing pictures in the viewfinder

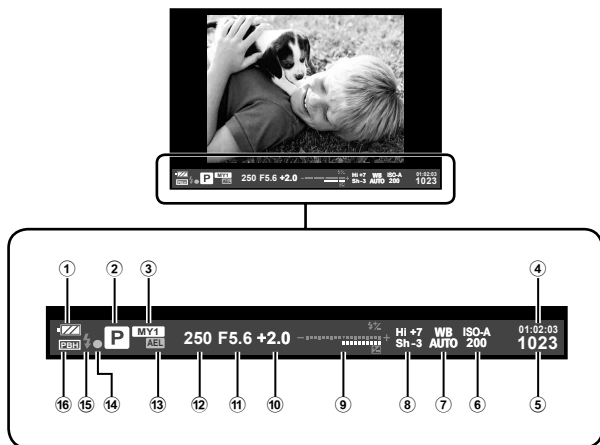

- ① Battery check
 - Lit up: Ready for use
 - Lit up: Battery is running low
 - Blinks (red) : Charging required
- ② Shooting mode.....P. 12, 57–61
- ③ Myset.....P. 42
- ④ Available recording time
- ⑤ Number of storable still pictures ... P. 110
- ⑥ ISO sensitivity.....P. 55
- ⑦ White balance.....P. 50
- ⑧ Highlight and shadow control.....P. 47
- ⑨ Top: Flash intensity controlP. 66
Bottom: Exposure compensation indicator.....P. 47
- ⑩ Exposure compensation value.....P. 47
- ⑪ Aperture value.....P. 57–58
- ⑫ Shutter speedP. 57–58
- ⑬ AE Lock (AEL).....P. 48
- ⑭ AF confirmation mark.....P. 14
- ⑮ Flash.....P. 65
(blinks: charging in progress)
- ⑯ PBH (displayed when camera is receiving power from power battery holder).....P. 92

You can switch the monitor display using the **INFO** button.

“Choosing the Information displayed in the monitor” (P. 39)

Choose the viewfinder display style. [Built-in EVF Style] (P. 92)

■ Framing pictures in the monitor

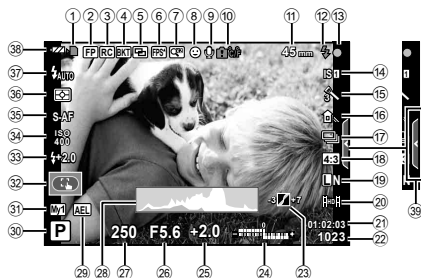

- | | |
|---|---|
| ① Card write indicator.....P. 5 | ②② Number of storable still pictures ...P. 110 |
| ② Super FP flash [FP].....P. 66 | ②③ Highlight and shadow control.....P. 47 |
| ③ RC mode.....P. 97 | ②④ Top: Flash intensity controlP. 66 |
| ④ Auto bracket [BKT]P. 63 | Bottom: Exposure compensation indicator.....P. 47 |
| ⑤ Multiple exposure [M]P. 62 | ②⑤ Exposure compensation value.....P. 47 |
| ⑥ High frame rate.....P. 92 | ②⑥ Aperture valueP. 57–58 |
| ⑦ Digital Tele-converter.....P. 64 | ②⑦ Shutter speedP. 57–58 |
| ⑧ Face priority [C]P. 46, 86 | ②⑧ HistogramP. 39, 40 |
| ⑨ Movie soundP. 68 | ②⑨ AE Lock [AEL].....P. 48 |
| ⑩ Internal temperature warning | ③⑩ Shooting mode.....P. 12, 57–61 |
| [C]/F.....P. 101 | ③① MysetP. 42 |
| ⑪ Focal length.....P. 104 | ③② Touch screen modeP. 27 |
| ⑫ Flash.....P. 65 | ③③ Flash intensity control.....P. 66 |
| (blinks: charging in progress) | ③④ ISO sensitivity.....P. 55 |
| ⑬ AF confirmation mark.....P. 14 | ③⑤ AF modeP. 43 |
| ⑭ Image stabilizer.....P. 49 | ③⑥ Metering mode.....P. 48 |
| ⑮ Art filterP. 18 | ③⑦ Flash mode.....P. 65 |
| Scene mode.....P. 19 | ③⑧ Battery check |
| Picture mode.....P. 52 | [] Lit up : Ready for use |
| ⑯ White balanceP. 50 | [] Lit up : Battery is running low |
| ⑰ Sequential shooting/self-timerP. 56 | [] Blinks (red) : Charging required |
| ⑱ Aspect ratio.....P. 55 | ③⑨ Live guide recall.....P. 21, 27 |
| ⑲ Record mode (still images).....P. 54 | |
| ⑲ Record mode (movies)P. 55 | |
| ⑲ Available recording time | |

You can switch the monitor display using the **INFO** button.

[INFO] “Choosing the Information displayed in the monitor” (P. 39)

Playback

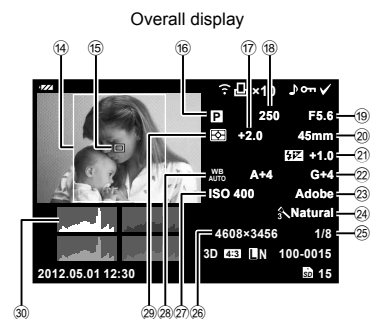
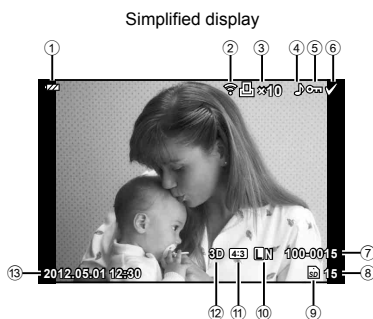

- ① Battery checkP. 30, 31
- ② Eye-Fi upload completeP. 93
- ③ Print reservation
Number of printsP. 81
- ④ Sound recordP. 68
- ⑤ ProtectP. 17
- ⑥ Image selected
- ⑦ File numberP. 91
- ⑧ Frame number
- ⑨ Storage deviceP. 103
- ⑩ Record modeP. 54
- ⑪ Aspect ratioP. 55, 72
- ⑫ 3D imageP. 61
- ⑬ Date and timeP. 9
- ⑭ Aspect borderP. 55
- ⑮ AF targetP. 44

- ⑯ Shooting modeP. 12, 57–61
- ⑰ Exposure compensationP. 47
- ⑱ Shutter speedP. 57–58
- ⑲ Aperture valueP. 57–58
- ⑳ Focal lengthP. 104
- ㉑ Flash intensity controlP. 66
- ㉒ White balance compensationP. 50
- ㉓ Color spaceP. 90
- ㉔ Picture modeP. 52
- ㉕ Compression rateP. 54
- ㉖ Pixel countP. 54
- ㉗ ISO sensitivityP. 55
- ㉘ White balanceP. 50
- ㉙ Metering modeP. 48
- ㉚ HistogramP. 39, 40

You can switch the monitor display using the **INFO** button.

 “Displaying information during playback” (P. 40)

Quick task index

Shooting



Taking pictures with automatic settings	▶ iAUTO (iAUTO)	12
Easy photography with special effects	▶ Art filter (ART)	18
Choosing an aspect ratio	▶ Aspect ratio	55
Quickly matching settings to the scene	▶ Scene (SCN)	19
Pro-level photography made simple	▶ Live guide	21
Taking pictures so that whites come out white and blacks come out black	▶ Exposure compensation	47
Taking pictures with a blurred background	▶ Live guide	21
	▶ Aperture priority shooting	57
Taking pictures that stop the subject in motion or convey a sense of motion	▶ Live guide	21
	▶ Shutter priority shooting	58
Taking pictures with the correct color	▶ White balance	50
	▶ One-touch white balance	51
Processing pictures to match the subject/ Taking monotone pictures	▶ Picture Mode	52
	▶ Art filter (ART)	18
Focus/Focusing on one area	▶ Touch screen	27
	▶ AF target	44
	▶ Zoom frame AF/zoom AF	45
When the camera won't focus on your subject	▶ Touch screen	27
	▶ Focus lock	44
Focusing on a small spot in the frame/ confirming focus before shooting	▶ Zoom frame AF/zoom AF	45
Recomposing photographs after focusing	▶ Focus lock	44
	▶ C-AF+TR (AF Tracking)	43
Turning off the beep speaker	▶ ■) (Beep sound)	88
Disabling the flash/taking photos without the flash	▶ Flash	65
	▶ ISO/DIS Mode	55/19
Reducing camera shake	▶ Image Stabilizer	49
	▶ Anti-Shock	89
	▶ Self-timer	56
	▶ Remote cable	106
Taking pictures of a subject against backlight	▶ Flash shooting	65
	▶ Gradation (Picture Mode)	52
Photographing fireworks	▶ Bulb/time photography	59
	▶ Scene (SCN)	19
Reducing image noise (mottling)	▶ Noise Reduct.	89

Quick task index

Taking pictures without white subjects appearing too white or black subjects appearing too dark	▶ Gradation (Picture Mode)	52
	▶ Histogram/Exposure compensation	39/47
	▶ Highlight and shadow control	47
Optimizing the monitor/ adjusting monitor hue	▶ Monitor brightness adjustment	85
	▶ Live View Boost	88
Checking set effect before taking a picture	▶ Preview function	58
	▶ Test Picture	94
Taking pictures while checking the level of the camera	▶ Level Gauge (Info Settings)	39
Shooting with deliberate composition	▶ Displayed Grid (Info Settings)	87
Zooming in on photos to check focus	▶ Auto (Rec View)	85
Self-portraits	▶ Self-timer	56
Sequential shooting	▶ Sequential shooting	56
Extending the useful life of the battery	▶ Sleep	88
Increasing the number of pictures that can be taken	▶ Record mode	54

Playback/Retouch



Viewing images on a TV	▶ Playback on TV	74
Viewing slideshows with background music	▶ Slideshow	71
Brightening shadows	▶ Shadow Adj (JPEG Edit)	72
Dealing with red-eye	▶ Redeye Fix (JPEG Edit)	72
Printing made easy	▶ Direct printing	82
Commercial prints	▶ Creating a print order	81
Simple photo sharing	▶ OLYMPUS PENPAL	76

Camera Settings



Restoring default settings	▶ Reset	42
Saving the settings	▶ Myset	42
Changing the menu display language	▶	85

Table of Contents



Basic guide	4	Information displayed in the monitor	30
Preparations for shooting	4	Information displayed in the monitor	30
Charging and inserting the battery	4	Shooting	30
Inserting and removing cards	5	Playback	32
Attaching a lens to the camera	6		
Attaching the flash unit	7		
Power on	8		
Setting the date/time	9		
Names of parts and functions	10	Quick task index	33
Names of parts	10	Basic photography/frequently-used options	39
Camera	10	Choosing the Information displayed in the monitor	39
Basic operations	12	Choosing a control panel for live view	39
Camera controls	12	Displaying information during playback	40
Mode dial	12	Other uses for the INFO button	41
The Shutter and  Buttons	13	Restoring default or custom settings	42
Taking photographs/shooting movies	14	Using reset settings	42
Playback/Erasing	16	Saving Myset	42
Viewing Images	16	Using Myset	42
Volume	17	Choosing a focus mode (AF mode)	43
Erasing images	17	Choosing a focus target (AF target)	44
Protecting images	17	Focus lock	44
Using art filters	18	Quick AF target selection	44
Shooting in scene mode	19	Toggling quickly between AF and MF	44
Using Movie Mode ()	20	Zoom frame AF/zoom AF	45
Shooting Options	21	Face priority AF/pupil detection AF	46
Using live guides	21	Taking pictures using face priority	46
Using the super control panel	22	Controlling exposure (exposure compensation)	47
Using live control	24		
Using the Multi-Function Button	25		
Using the menus	26		
Using the Touch screen	27		
Live Guides	27		
Shooting Mode	27		
Playback Mode	28		
Adjusting Settings	28		

Table of Contents

Changing the brightness of highlights and shadows	47
Choosing how the camera measures brightness (metering).....	48
Exposure lock (AE lock)	48
Reducing camera shake (the image stabilizer).....	49
Adjusting color (white balance)	50
White balance compensation ...	50
One-touch white balance.....	51
Processing options (picture mode)	52
Image quality (record mode)	54
Choosing a record mode	54
Setting the image aspect.....	55
ISO sensitivity.....	55
Sequential shooting/using the self timer	56

Other shooting options 57

“Point-and-shoot” photography (P program mode).....	57
Choosing aperture (A aperture-priority mode).....	57
Choosing shutter speed (S shutter-priority mode).....	58
Choosing aperture and shutter speed (M manual mode)	58
Choosing when the exposure ends (bulb/time photography)	59
Taking Panoramas.....	60
Taking pictures for a panorama	60
3D Photography.....	61

Recording multiple exposures in a single image (multiple exposure)	62
Varying settings over a series of photographs (bracketing)	63
Digital Zoom (Digital Tele-converter)	64

Flash shooting 65

Using a flash (flash photography)	65
Adjusting flash output (Flash intensity control).....	66
Using external flash units designated for use with this camera.....	66
Other external flash units	66

Shooting and viewing movies 67

Changing the settings for movie recording	67
Adding effects to a movie	67
Movie sound options (recording sound with movies).....	68
Viewing movies	68

Playback options 69

Single-frame playback	69
Canceling all protections.....	70
All-frame erase	70
Rotate	70
Slideshow.....	71
Editing still images.....	72
Image overlay	73
Audio recording.....	73
Viewing camera images on TV...74	

Sending and receiving images 76

- Sending images.....76
- Receiving images/adding a host.....76
- Editing the address book77
- Creating albums77

Using OLYMPUS Viewer 2 78

- Windows78
- Macintosh79

- Copying pictures to a computer without OLYMPUS Viewer 2.....79

Printing pictures 81

- Print reservation (DPOF)81
 - Creating a print order.....81
 - Removing all or selected pictures from the print order...81
- Direct printing (PictBridge)82
 - Easy printing.....83
 - Custom printing83

Camera setup 85

- Setup Menu85
 - 🕒 (Date/time setting)85
 - 🗨️ (Changing the display language)85
 - 📢 (Monitor brightness adjustment).....85
 - Rec View85
 - 🔊/🗨️ Menu Display85
 - Firmware.....85

Customizing camera settings 86

- Before Using the Custom/Accessory Port Menus86

- Custom Menu options.....86
 - 📷 AF/MF86
 - 📷 Button/Dial86
 - 📷 Release/📷87
 - 📷 Disp/📷/PC.....87
 - 📷 Exp/📷/ISO.....88
 - 📷 ⚡ Custom89
 - 📷 📷-Color/WB.....89
 - 📷 Record/Erase.....90
 - 📷 Movie92
 - 📷 Built-In EVF.....92
 - 📷 📷 Utility.....92
 - AEL/AFL.....93
 - Button Function.....93

- Accessory port menu options...95

- 📷 OLYMPUS PENPAL Share...95
- 📷 OLYMPUS PENPAL Album...95
- 📷 Electronic Viewfinder95

- Recording movies with the shutter button.....96

- Taking a photograph when recording ends.....96

- Wireless remote control flash photography97

Information 98

- Shooting tips and information...98
- Error codes100
- Cleaning and storing the camera.....102
 - Cleaning the camera102
 - Storage.....102

Table of Contents

Cleaning and checking the image pickup device.....	102
Pixel mapping - Checking the image processing functions.....	102
■ Card basics	103
Usable cards.....	103
Formatting the card	103
■ Battery and charger	104
■ Using an optional AC adapter	104
■ Using your charger abroad	104
■ Interchangeable lenses	104
M.ZUIKO DIGITAL lens specifications.....	105
■ Principal Accessories	106
Mount adapter	106
Remote cable (RM-UC1)	106
Converter lenses	106
Macro arm light (MAL-1)	107
Microphone set (SEMA-1)	107
Power Battery Holder (HLD-6).....	107
■ Exposure warning display	107
■ Flash modes that can be set by shooting mode	108
■ Flash synchronization and shutter speed	109
■ External flash shooting	109
■ Record mode and file size/ number of storable still pictures	110
■ Menu directory	111
■ Specifications	115

SAFETY PRECAUTIONS 118

■ **SAFETY PRECAUTIONS** **118**

System chart 126

Index 128

Use the **INFO** button to display photo info or control panels for choosing shooting options.

Choosing the Information displayed in the monitor

Press the **INFO** button to choose the information displayed when shooting.

Framing pictures in the viewfinder



Framing pictures in the monitor

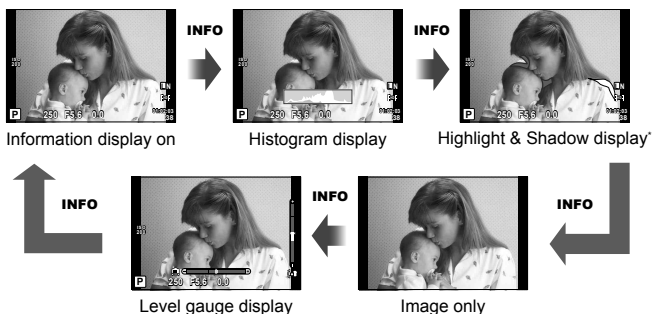

* You can display a framing grid or choose the type of grid displayed using [Grid/Info Settings] > [LV-Info]. (P. 87)

Choosing a control panel for live view

Shooting options can be displayed by pressing **OK**. You can choose the types of display available using the [Control Settings] option in the custom menus (P. 87).



*1 **ART** or **SCN**

*2 Displayed if [On] is selected in the [Control Settings] menu (P. 87).

Displaying information during playback

The **INFO** button can be used to choose the information displayed during playback.

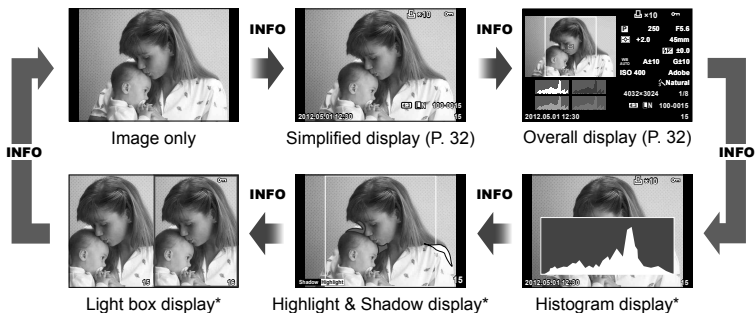

* Displayed when [On] is selected for [Info Settings] > [Info]. (P. 87)

Histogram display

Display a histogram showing the distribution of brightness in the image. The horizontal axis gives the brightness, the vertical axis the number of pixels of each brightness in the image. Areas above the upper limit at shooting are displayed in red, those below the lower limit in blue, and the area metered using spot metering in green.

Highlight & Shadow display

Areas above the upper limit of brightness for the image are shown in red, those below the lower limit in blue. [Histogram Settings] (P. 88)

Light box display

Compare two images side-by-side. Press **OK** to select the image on the opposite side of the display.

- The base image is displayed on the right. Use **<D>** or sub dial to highlight an image and press **OK** to move it to the left. The image to be compared to the image on the left can be selected on the right. To choose a different base image, highlight the right frame and press **OK**.
- Press **Fn1** to zoom the images in. Rotate the main dial to choose a zoom ratio. When images are zoomed in, use **Δ ∇ <D>** to scroll and the sub dial to select the image.

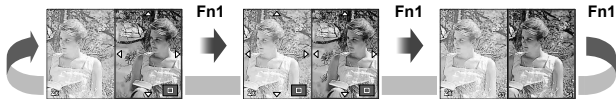

Other uses for the INFO button

■ One-touch white balance

Select [WB] or [WB] for one-touch white balance.

■ Color temperature

Select [CWB] to choose the color temperature. (P. 50)

■ Playback zoom

Press the **INFO** button to choose the zoom ratio for the zoom frame display.

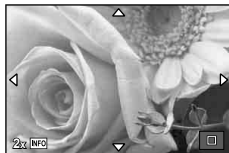

■ Highlight and shadow control

Highlights and shadows can be adjusted from the exposure compensation dialog. (P. 47)

■ Focal length

Select IS mode and choose a focal length for image stabilization. (P. 49)

■ Help

Help is displayed automatically about two seconds after an item is selected. To disable help, press the **INFO** button.

Press the **INFO** button again to re-enable help.



■ Manual flash compensation

Flash output can be selected from flash mode manual flash level options. (P. 65)

■ Manual exposure compensation for the zoom display

Press the **INFO** button to preview how the selected shutter speed and aperture affect exposure when you have zoomed in on your subject in mode **M** (BULB/TIME excluded). Settings can be adjusted using the arrow pad or dial. (P. 45)

■ Face priority AF/AF target mode

Press the **INFO** button in the AF target selection display to use the direction keys to select face-priority or AF target mode. (P. 44)

Restoring default or custom settings



Camera settings can be easily restored to one of three presets.

Reset: Restore default settings.

Myset: Restore preselected settings for **P**, **A**, **S**, or **M** mode. The shooting mode does not change. Up to four sets of preselected settings can be stored.



Quick Myset: Stored settings take effect while the **Fn1** or **Q** button is pressed. Shooting mode is adjusted to the preset settings.

Using reset settings

- 1 Select [Reset/Myset] in shooting menu  (P. 111).
- 2 Select [Reset] and press **OK**.
 - Highlight [Reset] and press **▷** to choose the reset type. To reset all settings except the time and date, highlight [Full] and press **OK**.
 "Menu directory" (P. 111)
- 3 Select [Yes] and press **OK**.



Saving Myset

- 1 Adjust settings in order to save.
- 2 Select [Reset/Myset] in shooting menu  (P. 111).
- 3 Select the desired destination ([Myset1]–[Myset4]) and press **▷**.
 - [Set] appears next to destinations ([Myset1]–[Myset4]) to which settings have already been saved. Selecting [Set] again overwrites the registered setting.
 - To cancel the registration, select [Reset].
- 4 Select [Set] and press **OK**.
 "Menu directory" (P. 111)

Using Myset

- 1 Select [Reset/Myset] in shooting menu  (P. 111).
- 2 Select the desired settings ([Myset1]–[Myset4]) and press **OK**.
- 3 Select [Set] and press **OK**.



Choosing a focus mode (AF mode)

Select a focusing method (focus mode).

- 1 Display the super control panel or live control and select the AF mode item.
- 2 Use the sub dial to choose a setting.
 - The selected AF mode is displayed on the monitor.

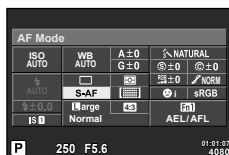

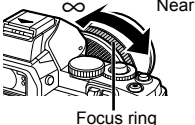
S-AF (single AF)	The camera focuses once when the shutter button is pressed halfway. When the focus is locked, a beep sounds, and the AF confirmation mark and the AF target mark light up. This mode is suitable for taking pictures of still subjects or subjects with limited movement.
C-AF (continuous AF)	The camera repeats focusing while the shutter button remains pressed halfway. When the subject is in focus, the AF confirmation mark lights up on the monitor and the beep sounds when the focus is locked at the first and second time. Even if the subject moves or you change the composition of the picture, the camera continues trying to focus. <ul style="list-style-type: none"> • Four Thirds system lenses focus using [S-AF].
MF (manual focus)	This function allows you to manually focus on any subject. [MF Assist] (P. 86): The focus ring can be used for zoom display. [Focus Ring] (P. 86): Choose the ∞ (close up) direction. 
S-AF+MF (simultaneous use of S-AF mode and MF mode)	After pressing the shutter button halfway to focus in [S-AF] mode, you can turn the focus ring to fine-adjust focus manually.
C-AF+TR (AF tracking)	Press the shutter button halfway to focus; the camera then tracks and maintains focus on the current subject while the shutter button is held in this position. <ul style="list-style-type: none"> • The AF target is displayed in red if the camera can no longer track the subject. Release the shutter button and then frame the subject again and press the shutter button halfway. • Four Thirds system lenses focus using [S-AF].

Tips

- The [RIs Priority S] (P. 87) and [RIs Priority C] (P. 87) options can be used to choose whether the shutter can be released when the camera is unable to focus.

Notes

- "Subjects that are difficult to focus on" (P. 98)

Choosing a focus target (AF target)

Use Δ ∇ \langle \triangleright to select AF targets.

- “All targets” mode is restored if you move the cursor off the screen.
- You can choose from the following three target types. Press the **INFO** button and use Δ ∇ .

All Targets

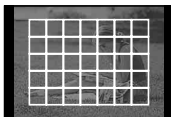

The camera automatically chooses from the full set of focus targets.

Single Target

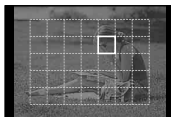

Select the focus target manually.

Group Target

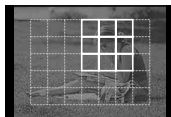

The camera automatically chooses from the targets in the selected group.

Focus lock

If the camera is unable to focus on your chosen subject, select single target mode and use focus lock to focus on another subject at about the same distance.

1 In [S-AF] mode, position the AF target over the subject and press the shutter button halfway.

- Make sure that the AF confirmation mark is lighting up.
- Focus locks while the shutter button is pressed halfway.

2 Keeping the shutter button pressed halfway, recompose the photograph and then press the shutter button the rest of the way down.

- Do not change the distance between the camera and the subject while pressing the shutter button halfway.

Quick AF target selection

You can save the selected AF target for quick recall using the **Fn1/Fn2** or \odot buttons.

- Select the AF target using [\square] Set Home] (P. 86).
- Assign [\square] Home] to the button using the [Button Function] option (P. 86).

toggling quickly between AF and MF

The **Fn1/Fn2** or \odot button can be used to toggle [MF].

- Assign the [MF] function to the button using the [Button Function] option (P. 86).

Zoom frame AF/zoom AF

You can also zoom in on an area of the image in the monitor and adjust focus. Choosing a high zoom ratio allows you to use autofocus to focus on a smaller area than is normally covered by the AF target. You can also position the focus target more precisely.

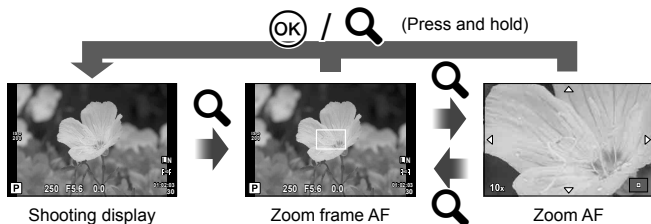

1 Before proceeding, use [Button Function] (P. 86) to assign [Q] to a button.

2 Press the Q button to display the zoom frame.

- If the camera was focused using autofocus just before the button was pressed, the zoom frame will be displayed at the current focus position.
- Use Δ ∇ \langle \triangleright to position the zoom frame.
- Press the **INFO** button and use Δ ∇ to choose the zoom ratio.

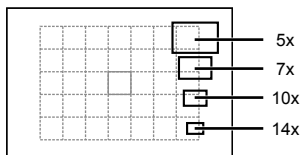

Comparison of AF and zoom frames

3 Press the Q button again to zoom in on the zoom frame.

- Use Δ ∇ \langle \triangleright to position the zoom frame.
- Rotate the dial to choose the zoom ratio.

4 Press the shutter button halfway to initiate autofocus.

- The zoom is cancelled.
- If [mode2] is selected for [LV Close Up Mode] (P. 88), pressing the shutter button will not cancel zoom and the camera will focus continuously while the shutter button is pressed halfway.

! Cautions

- Zoom is visible only in the monitor and has no effect on the resulting photographs.

Face priority AF/pupil detection AF

The camera detects faces and adjusts focus and digital ESP.

Taking pictures using face priority

- 1 Display the super control panel or live control and select the face priority item.
- 2 Use the sub dial to choose a setting.

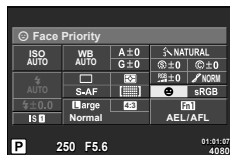

	Face Priority Off	Face priority off.
	Face Priority On	Face priority on.
	Face & Eye Priority On	The autofocus system selects the pupil of the eye closest to the camera for face-priority AF.
	Face & R. Eye Priority On	The autofocus system selects the pupil of the eye on the right for face-priority AF.
	Face & L. Eye Priority On	The autofocus system selects the pupil of the eye on the left for face-priority AF.

- 3 Point the camera at your subject.
 - If a face is detected, it will be indicated by a white border.

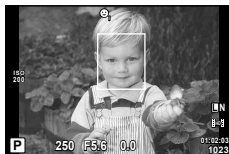

- 4 Press the shutter button halfway to focus.
 - When the camera focuses on the face in the white border, the border will turn green.
 - If the camera is able to detect the subject's eyes, it will display a green frame over the selected eye. (pupil detection AF)

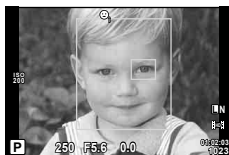

- 5 Press the shutter button the rest of the way down to shoot.

! Cautions

- Face priority applies only to the first shot in each sequence taken during sequential shooting.
- Depending on the subject, the camera may not be able to correctly detect the face.
- In metering modes other than [M] (Digital ESP metering), the camera will meter exposure for the selected position.

📌 Notes

- Face priority is also available in [MF]. Faces detected by the camera are indicated by white frames.

Controlling exposure (exposure compensation)

Rotate the sub dial to choose exposure compensation. Choose positive (“+”) values to make pictures brighter, negative (“-”) values to make pictures darker. Exposure can be adjusted by ± 3 EV.



Tips

To change the exposure adjustment interval.  [EV Step] (P. 88)/



Changing the direction of the dial.  [Dial Direction] (P. 87)/

If [Button Function] (P. 86) is used to assign  (exposure compensation) to a button, exposure compensation can be adjusted after  is pressed.

Cautions

- Exposure compensation is not available in **FAUTO**, **M**, or **SCN** modes.

Changing the brightness of highlights and shadows

Before shooting begins, use [Button Function] (P. 86) to assign  (exposure compensation) to a button. Press  and then the **INFO** button to display exposure compensation options. Use \leftarrow / \rightarrow to adjust exposure compensation. Adjust exposure downward to make shadows darker, upward to make highlights brighter.

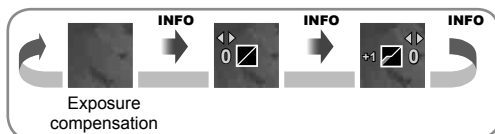







Choosing how the camera measures brightness (metering)

Choose how the camera meters subject brightness.

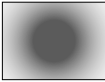
- 1 Display the super control panel or live control and select the metering item.
- 2 Use the sub dial to choose a setting.

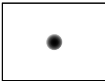

 Digital ESP metering	The camera meters exposure in 324 areas of the frame and optimizes exposure for the current scene or (if an option other than [OFF] is selected for [☺ Face Priority]) portrait subject. This mode is recommended for general use.
 Center weighted averaging metering	This metering mode provides the average metering between the subject and the background lighting, placing more weight on the subject at the center. 
 Spot metering	Choose this option to meter a small area (about 2% of the frame) with the camera pointed at the object you wish to meter. Exposure will be adjusted according to the brightness at the metered point. 
 HI Spot metering - highlight control	Increases spot metering exposure. Ensures bright subjects appear bright.
 SH Spot metering - shadow control	Lowers spot metering exposure. Ensures dark subjects appear dark.

- 3 Press the shutter button halfway.
 - Normally, the camera will start metering when the shutter button is pressed halfway and lock exposure while the shutter button is held in this position.

Exposure lock (AE lock)

Press **Fn1** to lock only exposure. Exposure lock can be used when you want to set focus and exposure separately while recomposing photographs, or if you want to take a series of photographs at the same exposure.

- [Button Function] can be used to assign exposure and focus lock to other buttons.



AE lock

Exposure locks and a **[AEL]** icon is displayed when the button is pressed once. Press the shutter button to take a picture.

- Press the button again to cancel AE lock.

Tips

To activate AE lock with a set metering mode.  [AEL Metering] (P. 88)

Reducing camera shake (the image stabilizer)

You can reduce the amount of camera shake that can occur when shooting in low light situations or shooting with high magnification.

- 1 Display the super control panel or live control and select the image stabilizer item.



- 2 Use the sub dial to choose a setting.

IS Off	Image stabilizer is off.
Auto	Image stabilizer is on.
Vertical IS	Image stabilization applies only to vertical () camera shake. Use when panning the camera horizontally.
Horizontal IS	Image stabilization applies only to horizontal () camera shake. Use when panning the camera horizontally with the camera held in portrait orientation.

Choosing a focal length (Micro Four Thirds/Four Thirds System lenses excluded)

Use focal length information to reduce camera shake when shooting with lenses that are not Micro Four Thirds or Four Thirds system lenses.

- 1 Select the image stabilizer item in the super control panel or live control and press the **INFO** button.



- 2 Use to choose a focal length and press .
 - Choose a focal length between 8 mm and 1000 mm.
 - Choose the value that most closely matches to the one that is printed on the lens.

Cautions

- The image stabilizer cannot correct excessive camera shake or camera shake that occurs when the shutter speed is set to the slowest speed. In these cases, it is recommended that you use a tripod.
- When using a tripod, set [Image Stabilizer] to [OFF].
- When using a lens with an image stabilization function, turn off the image stabilizer function of either the lens or the camera.
- You may notice an operating sound or vibration when the image stabilizer is activated.

Tips

Pressing the shutter button halfway activates image stabilization. [Half Way RIs With IS] (P. 87)

Adjusting color (white balance)

White balance (WB) ensures that white objects in images recorded by the camera appear white. [AUTO] is suitable in most circumstances, but other values can be selected according to the light source when [AUTO] fails to produce the desired results or you wish to introduce a deliberate color cast into your images.

- 1 Display the super control panel or live control and select the white balance item.



- 2 Use the sub dial to choose a setting.

WB mode		Color temperature	Light conditions
Auto white balance	WB AUTO	—	Use this mode for general use.
Preset white balance		5300K	For shooting outdoors on a clear day, or to capture the reds in a sunset or the colors in a fireworks display
		7500K	For shooting outdoors in the shadows on a clear day
		6000K	For shooting outdoors on a cloudy day
		3000K	For shooting under a tungsten light
		4000K	For subjects lit by fluorescent lights
		—	For underwater photography
		5500K	For flash shooting
One-touch white balance (P. 51)		Color temperature set by one-touch WB.	When color temperature selection is difficult
Custom white balance	CWB	2000K– 14000K	After pressing the INFO button, use <Left><Right> buttons to select a color temperature and then press OK .

White balance compensation

This function lets you make fine changes to the auto WB and preset WB settings.

- 1 Select [WB] in Custom Menu (P. 86) tab .
- 2 Select the option to be modified and press .
- 3 Select a slider with and use to choose the amount.

Adjusting the white balance in the A direction (Amber-Blue)

Higher values produce “warmer” (redder) tints, lower values “cooler” (bluer) tints.

Adjusting the white balance in the G direction (Green-Magenta)

Higher values produce greener tints, lower values tints that are more purple.



- 4** Press **OK** to save settings and exit.

Tips

- To display a test photograph taken at the selected white balance value, press the **Q** button.
- Adjusting all WB mode settings at once.  [All **WBZ**] (P. 89)

One-touch white balance

Measure white balance by framing a piece of paper or other white object under the lighting that will be used in the final photograph. This is useful when shooting a subject under natural light, as well as under various light sources with different color temperatures.

- 1** Select [**W1**] or [**W2**] (one-touch white balance 1 or 2) and press the **INFO** button.
- 2** Photograph a piece of colorless (white or gray) paper.
 - Frame the object so that it fills the display and no shadows fall it.
 - The one-touch white balance screen appears.
- 3** Select [Yes] and press **OK**.
 - The new value is saved as a preset white balance option.
 - The new value is stored until one-touch white balance is measured again. Turning the power off does not erase the data.

Tips

If the subject is too bright or too dark or visibly tinted, the message “WB NG Retry” will be displayed and no value will be recorded. Correct the problem and repeat the process from Step 1.

















Processing options (picture mode)

Select a picture mode and make individual adjustments to contrast, sharpness, and other parameters. Changes to each picture mode are stored separately.

- 1 Select [Picture Mode] in shooting menu  (P. 111).
- 2 Select an option with Δ ∇ and press \odot .



Picture modes

 i-Enhance	Produces more impressive-looking results suited to the scene.
 Vivid	Produces vivid colors.
 Natural	Produces natural colors.
 Muted	Produces flat tones.
 Portrait	Produces beautiful skin tones.
Monotone	Produces black and white tone.
Custom	Select one picture mode, set the parameters, and register the setting.
 Pop Art	Choose an art filter and select the desired effect.
 Soft Focus	
 Pale&Light Color	
 Light Tone	
 Grainy Film	
 Pin Hole	
 Diorama	
 Cross Process	
 Gentle Sepia	
 Dramatic Tone	
 Key Line	

3 Press \blacktriangleright to display settings for the selected option.

		\uparrow	\downarrow	M	C
Contrast	Distinction between light and dark	✓	✓	✓	✓
Sharpness	Sharpness of the image	✓	✓	✓	✓
Saturation	Vividness of the color	✓	✓	—	✓
Gradation	Adjust tone (gradation).				
Auto	Divides the image into detailed regions and adjusts the brightness separately for each region. This is effective for images with areas of large contrast in which the whites appear too bright or the blacks appear too dark.	✓	✓	✓	✓
Normal	Use [Normal] mode for general uses.				
High Key	Gradation for a bright subject.				
Low Key	Gradation for a dark subject.				
Effect (i-Enhance)	Sets the extent that the effect will be applied.	✓	—	—	✓
B&W Filter (Monotone)	Creates a black and white image. The filter color is brightened and the complementary color is darkened.				
N:Neutral	Creates a normal black and white image.				
Ye:Yellow	Reproduces clearly defined white cloud with natural blue sky.	—	—	✓	✓
Or:Orange	Slightly emphasizes colors in blue skies and sunsets.				
R:Red	Strongly emphasizes colors in blue skies and brightness of crimson foliage.				
G:Green	Strongly emphasizes colors in red lips and green leaves.				
Pict. Tone (Monotone)	Colors the black and white image.				
N:Neutral	Creates a normal black and white image.				
S:Sepia	Sepia	—	—	✓	✓
B:Blue	Bluish				
P:Purple	Purplish				
G:Green	Greenish				

! Cautions

- Changes to contrast have no effect at settings other than [Normal].

Image quality (record mode)

Select an image quality for photographs and movies according to their intended use, for example retouching on a computer or display on the web.

Choosing a record mode

- 1 Display the live control and highlight the current record mode option for photographs or movies.
 - Photo image quality can also be adjusted from the super control panel.
- 2 Use the sub dial to choose a setting.



Record mode

Record modes (still images)

Choose from RAW and JPEG (L, M, N, and S) modes. Choose a RAW+JPEG option to record both a RAW and a JPEG image with each shot. JPEG modes combine image size (L, M, and S) and compression ratio (SF, F, N, and B). The options available can be selected using the [◀ Set] (P. 90) option in the custom menus.

Image size		Compression rate				Application
Name	Pixel count	SF (Super Fine)	F (Fine)	N (Normal)	B (Basic)	
L (Large)	4608×3456*	L SF	L F*	L N*	L B	Select for the print size
M (Middle)	3200×2400	M SF	M F	M N*	M B	
	2560×1920*					
	1920×1440					
	1600×1200					
S (Small)	1280×960*	S SF	S F	S N*	S B	For small prints and use on a web site
	1024×768					
	640×480					

* Default.

- The size of [M] and [S] images can be selected using the [Pixel Count] (P. 90) option in the custom menus.

RAW image data

This format (extension “.ORF”) stores unprocessed image data for later processing. RAW image data can not be viewed using other cameras or software, and RAW images can not be selected for printing. JPEG copies of RAW images can be created using this camera.

Editing still images” (P. 72)

■ Record modes (movies)

Record mode	Pixel count	Frame rate	File format	Application
Full HD Fine	1920×1080	59.94i ^{*2}	MPEG-4 AVC/ H.264 ^{*1}	Display on TVs and other devices
Full HD Normal	1920×1080	59.94i ^{*2}		
HD Fine	1280×720	59.94p ^{*2}		
HD Normal	1280×720	59.94p ^{*2}	Motion JPEG ^{*4}	For computer playback or editing.
HD	1280×720	Approx. 30 fps ^{*3}		
SD	640×480			

- Depending on the type of card used, recording may end before the maximum length is reached.

*1 Individual movies can be up to 29 minutes long.

*2 Image sensor output about 30 fps.

*3 The frame rate may drop when an art filter is used.

*4 Files may be up to 2GB in size.

Setting the image aspect

You can change the aspect ratio (horizontal-to-vertical ratio) when taking pictures using live view. Depending on your preference, you can set the aspect ratio to [4:3] (standard), [16:9], [3:2], [1:1], or [3:4].

- 1 Display the super control panel or live control and select the aspect ratio item.
- 2 Use the sub dial to choose a setting.

⚠ Cautions

- JPEG images are cropped to the selected aspect ratio; RAW images, however, are not cropped but are instead saved with information on the selected aspect ratio.
- When RAW images are played back, the selected aspect ratio is shown by a frame.

💡 Tips

For information on cropping existing photographs or changing their aspect ratio, see “Editing still images” (P. 72).



ISO sensitivity

Increasing ISO sensitivity increases noise (graininess) but allows photographs to be taken when lighting is poor. The setting recommended in most situations is [AUTO], which starts at ISO 200 — a value that balances noise and dynamic range — and then adjusts ISO sensitivity according to shooting conditions.

- 1 Display the super control panel or live control and select the ISO sensitivity item.
- 2 Use the sub dial to choose a setting.

AUTO	The sensitivity is set automatically according to the shooting conditions.
200–25600	Sensitivity is set to the selected value.





Tips

- Choosing the standard and maximum ISO sensitivities.  [ISO-Auto Set] (P. 88) / Choosing the ISO step increment.  [ISO Step] (P. 88) / Using auto ISO sensitivity in mode **M**.  [ISO-Auto] (P. 89)



Sequential shooting/using the self timer

Keep the shutter button pressed all the way down to take a series of photos. Alternatively, you can take pictures using the self timer.

- 1 Display the super control panel or live control and select .
- 2 Use the sub dial to choose a setting.

	Single-frame shooting	Shoots 1 frame at a time when the shutter button is pressed (normal shooting mode).
	Sequential H	Photographs are taken at about 9 frames per second (fps) while the shutter button is pressed all the way down. Focus, exposure, and white balance are fixed at the values for the first shot in each series ([S-AF], [MF]).
	Sequential L	Photographs are taken at about 4 frames per second (fps) while the shutter button is pressed all the way down. Focus and exposure are fixed according to the options selected for [AF Mode] (P. 86) and [AEL/AFL] (P. 86).
	Self-timer 12 SEC	Press the shutter button halfway to focus, the rest of the way down to start the timer. First, the self-timer lamp lights up for approximately 10 seconds, then it blinks for approximately 2 seconds and the picture is taken.
	Self-timer 2 SEC	Press the shutter button halfway to focus, the rest of the way down to start the timer. The self-timer lamp blinks for approximately 2 seconds, and then the picture is taken.

Notes

- To stop the timer before a picture is taken, press  or  or  or the **MENU** button.

Cautions

- The confirmation display is not available during sequential shooting at frame rates under 5 fps. At rates of 5 fps or above, the last photo taken will be displayed during shooting.
- During sequential shooting, if the battery check blinks due to low battery, the camera stops shooting and starts saving the pictures you have taken on the card. The camera may not save all of the pictures depending on how much battery power remains.
- Display quality may drop during sequential shooting. Filter effects are not reflected in the display.
- Fix the camera securely on a tripod for self-timer shooting.
- If you stand in front of the camera to press the shutter button halfway when using the self-timer, the photograph may be out of focus.

“Point-and-shoot” photography (P program mode)

In mode **P**, the camera automatically adjusts shutter speed and aperture in response to subject brightness. Set the mode dial to **P**.

Framing pictures in the viewfinder

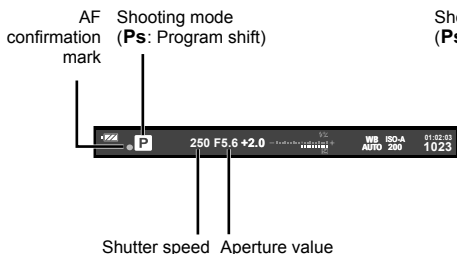

Framing pictures in the monitor

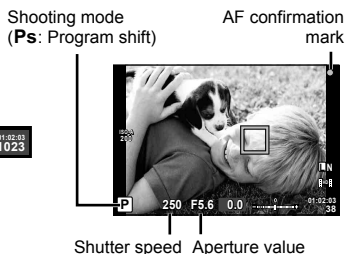

- The shutter speed and aperture selected by the camera are displayed.
- Rotate the main dial for program shift.
- Rotate the sub dial to choose exposure compensation.

! Cautions

- The shutter speed and aperture displays flash if the camera is unable to achieve optimal exposure. See “Exposure warning display” (P. 107).

Program shift (Ps)

In **P** and **ART** modes, you can adjust aperture and shutter speed without affecting exposure compensation. A “s” icon appears next to the shooting mode when program shift is in effect. To cancel program shift, rotate the dial until “s” is no longer displayed.

! Cautions

- Program shift is not available when you are using a flash.

💡 Tips

Changing the role assigned to the dial. [Dial Function] (P. 87)

Choosing aperture (A aperture-priority mode)

In mode **A**, you choose the aperture and let the camera automatically adjust shutter speed for optimal exposure. After rotating the mode dial to **A**, rotate the main dial to choose the aperture.

- Rotate the sub dial to choose exposure compensation.
- Larger apertures (lower f-numbers) decrease depth of field (the area in front of or behind the focus point that appears to be in focus), softening background details. Smaller apertures (higher f-numbers) increase depth of field.



Aperture value

Preview function

You can preview depth of field (the area behind and in front of the subject that appears to be in focus). The camera stops aperture down to the selected value while the button to which [Preview] has been assigned is pressed. [Button Function] (P. 93)



Tips

Changing the role assigned to the dial. [Dial Function] (P. 87)

Choosing shutter speed (S shutter-priority mode)

In mode **S**, you choose the shutter speed and let the camera automatically adjust aperture for optimal exposure. After rotating the mode dial to **S**, rotate the main dial to choose the shutter speed.

- Rotate the sub dial to choose exposure compensation.
- A fast shutter speed can freeze a fast action scene without any blur. A slow shutter speed will blur a fast action scene. This blurring will give the impression of dynamic motion.



Shutter speed



Tips

Changing the role assigned to the dial. [Dial Function] (P. 87)

Choosing aperture and shutter speed (M manual mode)

In mode **M**, you choose both the aperture and the shutter speed. At a speed of BULB, the shutter remains open while the shutter button is pressed. After rotating the mode dial to **M**, rotate the main dial to choose the aperture and the sub dial to choose the shutter speed.

- Shutter speed can be set to values between 1/4000 and 60 seconds or to [BULB] or [LIVE TIME].



Cautions

- Exposure compensation is not available in **M** mode.

Choosing when the exposure ends (bulb/time photography)

Use for night landscapes and fireworks. Shutter speeds of [BULB] and [LIVE TIME] are available in mode **M**.

Bulb photography (BULB): The shutter remains open while the shutter button is pressed. The exposure ends when the shutter button is released.

Time photography (TIME): The exposure begins when the shutter button is pressed all the way down. To end the exposure, press the shutter button all the way down again.

Viewing Progress in the Monitor

To view the progress of the exposure during shooting, choose a display interval for [Live BULB] (P. 89) or [Live TIME] (P. 89). This makes it easier to choose when to end the exposure. If [Live TIME] is selected, the display can be refreshed by pressing the shutter button halfway during time photography.



Tips

Changing the role assigned to the dial. [Dial Function] (P. 87) /

To automatically end bulb shooting after a specified period of time. [BULB/TIME Timer] (P. 89) / To fix the focus during manual focus shooting. [BULB/TIME Focusing] (P. 86)



Cautions

- ISO sensitivity can be set to values between ISO 200 and 1600 for live bulb and live time photography.
- To reduce camera blur during long exposures, mount the camera on a tripod and use a remote cable (P. 106).
- The following features are not available during long exposures:
Sequential shooting/self-timer shooting/AE bracket shooting/image stabilizer/
flash bracketing/multiple exposure
* An option other than [Off] is selected for [Live BULB] or [Live TIME].

Noise in images

While shooting at slow shutter speeds, noise may appear on-screen. These phenomena are caused when current is generated in those sections of the image pickup device that are not normally exposed to light, resulting in a rise in temperature in the image pickup device or image pickup device drive circuit. This can also occur when shooting with a high ISO setting in a high-temperature environment. To reduce this noise, the camera activates the noise reduction function. [Noise Reduct.] (P. 89)

Taking Panoramas



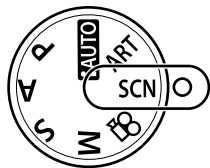

If you have installed the supplied computer software, you can use it to join pictures together to form a panorama. Images are framed in the monitor.  "Using OLYMPUS Viewer 2" (P. 78)

Taking pictures for a panorama

1 Rotate the mode dial to **SCN**.



2 Select [Panorama] and press .

3 Use     to choose a pan direction.

4 Take a picture, using the guides to frame the shot.

- Focus, exposure, and other settings are fixed at the values for the first shot.



5 Take the remaining images, framing each shot so that the guides overlap with the previous picture.

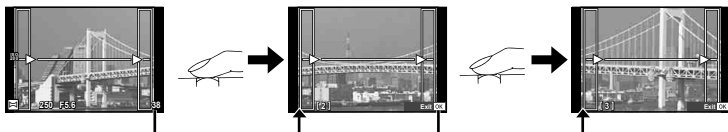



- A panorama may include up to 10 images. A warning indicator () is displayed after the tenth shot.

6 After taking the last shot, press  to end the series.

Cautions

- During panorama shooting, the image previously taken for position alignment will not be displayed. With the frames or other markers for display in the images as a guide, set the composition such that the edges of the overlapping images overlap within the frames.

Notes

- Pressing  before shooting the first frame returns to the scene mode selection menu. Pressing  in the midst of shooting ends the sequence of panorama shooting, and allows you to continue with the next one.

3D Photography

Take 3D photographs. The results can be viewed on devices that support 3D display. Images are framed in the monitor. The camera monitor can not be used to view images in 3D.

1 Rotate the mode dial to **SCN**.

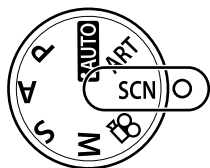

2 Select [3D Photo] and press **OK**.

- The subject is displayed in the monitor.

3 Press the shutter button to take the first shot and keep the shutter button in this position.

- Focus and exposure are locked at the values for the first shot.
- If you are using a 3D lens, shooting is completed the first time the shutter button is pressed.

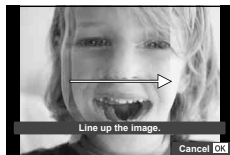

4 Move the camera horizontally without rotation until the first shot is superimposed on your subject. The camera will take the second shot automatically.

- Do not adjust focus or zoom.
- If the camera does not take the second shot automatically or if you released the shutter button before the second shot was taken, press the shutter button all the way down again.

5 The two images are combined automatically.

- If the camera displays the message [3D photo was not created.], take the photograph again. The two shots are saved to separate files.

! Cautions

- The quality of the display in the monitor drops slightly.
- Adjusting zoom after the first shot is taken cancels the first shot.
- The camera focuses on the subject in the center focus point only.
- Image size is fixed at 1920 × 1080.
- Image size is fixed at 1824 × 1024 SF when a 3D lens is used.
- Manual focus lenses can not be used.
- Depending on the lens and camera settings, the 3D effect may not be visible.
- The camera will not go to sleep during 3D photography.
- RAW photography is not available.
- Frame coverage is not 100%.

📝 Notes

- To retake the photograph after taking the first shot, press **⏏**. Press **OK** to save the first shot and exit without recording a 3D image.

Recording multiple exposures in a single image (multiple exposure)

Record multiple exposures in a single image, using the option currently selected for image quality.

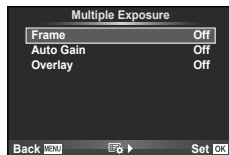

- 1 Select [Multiple Exposure] in shooting menu  (P. 111).
- 2 Adjust settings.

Frame	Select [2f].
Auto Gain	When set to [On], the brightness of each frame is set to 1/2 and the images are overlaid. When set to [Off], the images are overlaid with the original brightness of each frame.
Overlay	When set to [On], a RAW image recorded on a card can be overlaid with multiple exposures and stored as a separate image. The number of pictures taken is one.





-  is displayed in the monitor while multiple exposure is in effect.

3 Take pictures.

-  is displayed in green when shooting starts.
- Press  to delete the last shot.
- The previous shot is superimposed on the view through the lens as a guide to framing the next shot.



Tips

- To overlay 3 or more frames: Select RAW for  (P. 54) and use the [Overlay] option to make repeated multiple exposures.
- For more information on overlaying RAW images:  "Image overlay" (P. 73)

Cautions

- The camera will not go to sleep while multiple exposure is in effect.
- Photographs taken with other cameras can not be included in a multiple exposure.
- When [Overlay] is set to [On], the images displayed when a RAW image is selected are developed with the settings at the time of shooting.
- To set the shooting functions, cancel multiple exposure shooting first. Some functions cannot be set.
- Multiple exposure is cancelled automatically from the first picture in the following situations.
 - The camera is turned off/The  button is pressed/The **MENU** button is pressed/The shooting mode is set to a mode other than **P, A, S, M**/The battery power runs out/Any cable is connected to the camera
- When a RAW image is selected using [Overlay], the JPEG image for the image recorded in JPEG+RAW is displayed.
- When shooting multiple exposures using bracketing, priority is given to multiple exposure shooting. While the overlay image is being saved, bracketing is reset to the factory default setting.

Varying settings over a series of photographs (bracketing)

“Bracketing” refers to the act of varying settings automatically over a series of shots or a series of images to “bracket” the current value.

- 1 Select [Bracketing] in shooting menu (P. 111).



- 2 Choose a bracketing type.

- **BKT** is displayed in the monitor.

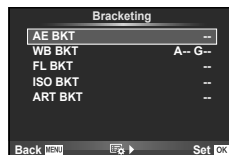

AE BKT (AE bracketing)

The camera varies exposure by 0.3EV, 0.7EV, or 1.0EV over three shots. In single-frame shooting mode, one photograph is taken each time the shutter button is pressed all the way down, while in sequential shooting mode the camera continues to take shots in the following order while the shutter button is pressed all the way down: no modification, negative, positive. Number of shots: 2, 3, 5, or 7

- The **BKT** indicator turns green during bracketing.
- The camera modifies exposure by varying aperture and shutter speed (mode **P**), shutter speed (modes **A** and **M**), or aperture (mode **S**).
- The camera brackets the value currently selected for exposure compensation.
- The size of the bracketing increment changes with the value selected for [EV Step]. (P. 88)

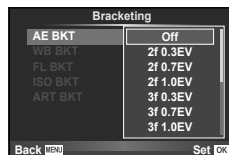

WB BKT (WB bracketing)

Three images with different white balances (adjusted in specified color directions) are automatically created from one shot, starting with the value currently selected for white balance.

- White balance can be varied by 2, 4, or 6 steps on each of the A–B (Amber–Blue) and G–M (Green–Magenta) axes.
- The camera brackets the value currently selected for white balance compensation.
- No pictures will be taken during WB bracketing if there is not enough memory on the card for the selected number of frames.



FL BKT (FL bracketing)

The camera varies flash level over three shots (no modification on the first shot, negative on the second, and positive on the third). In single-frame shooting, one shot is taken each time the shutter button is pressed; in sequential shooting, all shots are taken while the shutter button is pressed.

- The **BKT** indicator turns green during bracketing.
- The size of the bracketing increment changes with the value selected for [EV Step]. (P. 88)

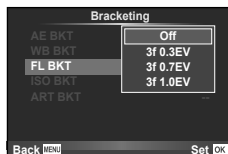

ISO BKT (ISO bracketing)

The camera varies sensitivity by 0.3 EV, 0.7 EV, or 1.0 EV over three shots (no modification on the first shot, negative on the second, and positive on the third), bracketing the current sensitivity setting (or if auto sensitivity is selected, the optimal sensitivity setting) while keeping shutter speed and aperture fixed. In single-frame shooting, one shot is taken each time the shutter button is pressed; in sequential shooting, all shots are taken while the shutter button is pressed.

- The size of the bracketing increment does not change with the value selected for [ISO Step]. (P. 88)
- Bracketing is performed regardless of the upper limit set with [ISO-Auto Set]. (P. 88)

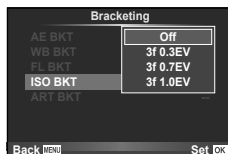

ART BKT (ART bracketing)

Each time the shutter is released, the camera records multiple images, each with a different art filter setting. You can turn art filter bracketing on or off separately for each picture mode.

- Recording may take some time.
- ART BKT can not be combined with WB BKT or ISO BKT.

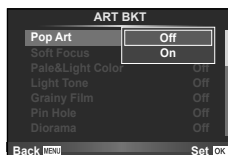

Digital Zoom (Digital Tele-converter)

Digital Tele-converter is used to zoom in beyond the current zoom ratio. The camera saves the center crop. Zoom is increased by about 2×.

- 1 Select [On] for [Digital Tele-converter] in Shooting menu (P. 111).
- 2 The view in the monitor will be enlarged by a factor of two.
 - The subject will be recorded as it appears in the monitor.

! Cautions

- Digital zoom is not available with multiple exposures or when , , , , or is selected in **SCN** mode.
- When a RAW image is displayed, the area visible in the monitor is indicated by a frame.

3 Flash shooting

The built-in flash can be set manually as required. The built-in flash can be used for flash photography in a variety of shooting conditions.

Using a flash (flash photography)

1 Attach the flash unit and raise the flash head.





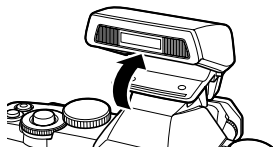



-  "Attaching the flash unit" (P. 7)

2 Display the super control panel or live control and highlight the flash mode.



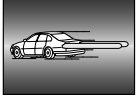

3 Use the sub dial to choose a setting.

- The options available and the order in which they are displayed vary depending on the shooting mode.  "Flash modes that can be set by shooting mode" (P. 108)

	Auto flash	The flash fires automatically in low light or backlight conditions.
	Fill-in flash	The flash fires regardless of the light conditions.
	Flash off	The flash does not fire.
	Red-eye reduction flash	This function allows you to reduce the red-eye phenomenon. In S and M mode, the flash always fires.
	Slow synchronization (1st curtain)	Slow shutter speeds are used to brighten dimly-lit backgrounds.
	Slow synchronization (1st curtain)/Red-eye reduction flash	Combines slow synchronization with red-eye reduction.
	Slow synchronization (2nd curtain)	The flash fires just before the shutter closes to create trails of light behind moving light sources. 
	Manual	For users who prefer manual operation. If you press the INFO button, you can use the dial to adjust the flash level.

4 Press the shutter button all the way.

Cautions

- In [], after the pre-flashes, it takes about 1 second before the shutter is released. Do not move the camera until shooting is complete.
- [] may not work effectively under some shooting conditions.
- When the flash fires, the shutter speed is set to 1/250 sec. or slower. When shooting a subject against a bright background with the fill-in flash, the background may be overexposed.

Adjusting flash output (Flash intensity control)

Flash output can be adjusted if you find that your subject appears overexposed, or is underexposed even though the exposure in the rest of the frame is just right.

- 1 Display the super control panel or live control and select the flash intensity control item.
- 2 Use the sub dial to choose a setting.



Tips

For information on flash bracketing:  "FL BKT (FL bracketing)" (P. 63)

Cautions

- This does not work when the flash control mode on the electronic flash is set to MANUAL.
- If flash intensity is adjusted on the electronic flash, it will be combined with the camera's flash intensity setting.
- When $[1/2] + [2]$ is set to [On], the flash intensity value will be added to the exposure compensation value. (P. 89)

Using external flash units designated for use with this camera

Optional external flash units designated for use with this camera support a wide variety of options for flash photography, including automatic flash control, super FP, and wireless flash control (P. 97).

Other external flash units

Observe the following precautions when mounting an external flash unit not designated for use with this camera on the camera hot shoe:

- Using obsolete flash units that apply currents of more than about 24 V to the camera hot shoe X-contact will damage the camera.
- Connecting flash units with signal contacts that do not conform to Olympus specifications may damage the camera.
- Use only with the camera in shooting mode **M** at shutter speeds slower than 1/180s and at ISO settings other than [AUTO].
- Flash control can only be performed by manually setting the flash to the ISO sensitivity and aperture values selected with the camera. Flash brightness can be adjusted by adjusting either ISO sensitivity or aperture.
- Use a flash with an angle of illumination suited to the lens. Angle of illumination is usually expressed using 35-mm format equivalent focal lengths.

4 Shooting and viewing movies

Use the **Ⓞ** button to record High Definition (HD) movies with sound. In movie mode, you can create movies that take advantage of the effects available in modes **A** and **M**.

Changing the settings for movie recording

Adding effects to a movie

- 1 After selecting **Ⓞ** mode, display the live control (P. 24) and use **△** **▽** to highlight the shooting mode.
- 2 Use **◀▶** to choose a mode and press **Ⓞ**.



P	Optimal aperture is set automatically according to the brightness of the subject.
A	Depiction of background is changed by setting the aperture. Use a dial to choose the aperture.
S	Shutter speed affects how the subject appears. Use a dial to select the shutter speed. Shutter speed can be set to values between 1/30 s and 1/4000 s.
M	You control both aperture and shutter speed. Use the sub dial to choose the aperture, the main dial to choose the shutter speed. Shutter speed can be set to values between 1/30 s and 1/4000 s. Sensitivity can be set manually to values between ISO 200 and 3200; auto ISO sensitivity control is not available.
ART1-ART11	Movie can be recorded with effects of art filter mode.  "Using art filters" (P. 18)

⚠ Cautions

- When recording a movie, you cannot change the settings for exposure compensation, aperture value, and shutter speed.
- If [Image Stabilizer] is activated while recording a movie, the recorded image is enlarged slightly. Even if [Vertical IS] or [Horizontal IS] is selected, the setting for [Auto] is applied.
- Stabilization is not possible when the camera shake is excessive.
- When using a lens with the image stabilizer function, turn off the image stabilizer function of either the lens or the camera.
- When the inside of the camera becomes hot, shooting is automatically stopped to protect the camera.
- With some art filters, [C-AF] operation is limited.
- Cards with an SD speed class of 6 or above are recommended for movie recording.

Movie sound options (recording sound with movies)

- 1 Display the live control (P. 24) and select the Movie  item using Δ ∇ .
- 2 Switch ON/OFF using \triangleleft \triangleright and press \odot .

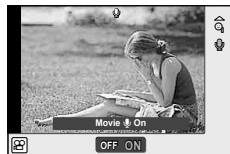

! Cautions

- When recording sound in a movie, the sound made by the lens and camera operating may be recorded. If desired, you can reduce these sounds by shooting with [AF Mode] set to [S-AF], or by limiting the amount of times you press the buttons.
- No sound is recorded in [ART7] (Diorama) mode.

Viewing movies

- 1 Display a movie in single-frame playback and press \odot .
- 2 Select [Movie Play] using Δ ∇ and press \odot to begin playback.

- The following operations can be performed during movie playback:



\odot	Pause or resume playback. <ul style="list-style-type: none"> • While playback is paused, press Δ to display the first frame and press ∇ to display the last frame. Press \triangleleft \triangleright to rewind or advance one frame. Press and hold the button to rewind or advance in succession. 	
\triangleleft / \triangleright	Advance or rewind a movie.	
Δ / ∇	Adjust volume.	

Elapsed time/Total recording time

! Cautions

- We recommend using the supplied PC computer software to play movies on a computer. Before launching the software for the first time, connect the camera to the computer.

💡 Tips

Recording movies with the shutter button  "Recording movies with the shutter button" (P. 96) /

Reducing wind noise.  [Wind Noise Reduction] (P. 92)/

Choosing a recording level.  [Recording Volume] (P. 92)

5 Playback options

Single-frame playback

Press the  button to view pictures full frame. Press the shutter button halfway to return to shooting mode.

Index display/calendar display

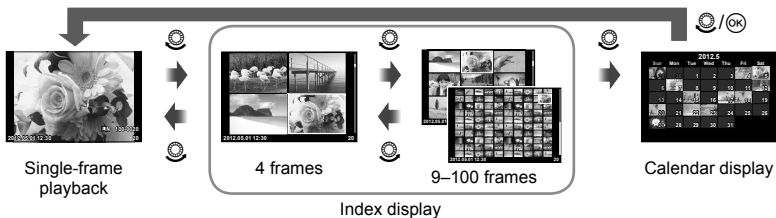

Only items for which [On] is selected are displayed. /Info Settings] (P. 87)

Playback zoom (close-up playback)

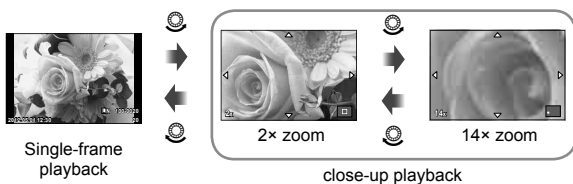

Sub dial (⊙)	Next (⊙)/previous (⊙)
Main dial (⊙)	Zoom in (⊙)/zoom out (⊙)
⊙ (Movie)	Select picture (selected pictures are marked with ✓; press again to deselect)
Fn1	View picture using zoom frame (P. 70)
Fn2	Protect picture (P. 17)
INFO	Single-image playback: View photo info (P. 40) Close-up playback: Choose operation
	Delete picture (P. 17)
OK	View menus (in calendar playback, press this button to exit to single-frame playback)
Arrow pad (Δ ∇ ◀ ▶)	Single-frame playback: Next (▶)/previous (◀)/playback volume (Δ ∇) Close-up playback: Scroll image Index/calendar playback: Highlight image

■ Using the Zoom Frame

The zoom frame can be used to zoom in on images.

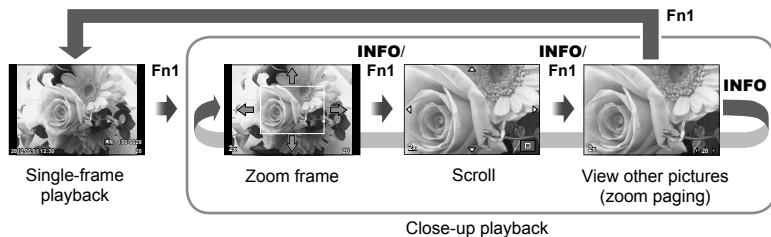

Arrow pad (Δ ∇ \triangleleft \triangleright)	Position the zoom frame. In zoom paging, use \triangleleft \triangleright to view other pictures at the current zoom ratio.
Fn1 or INFO	Choose between zoom frame, zoom scroll, and zoom paging.

Canceling all protections

This function lets you cancel the protection of several images at one time.

- 1 Select [Reset Protect] in the \square (playback) menu (P. 111).
- 2 Select [Yes] and press OK .

All-frame erase

Erase all images on the memory card.

- 1 Select [Card Setup] in shooting menu \mathbf{M} (P. 111).
- 2 Select [All Erase] and press OK .
 - The [Format] option (P. 103) can be used to delete non-image data.
- 3 Select [Yes] and press OK .

Rotate

Choose whether to rotate photographs.

- 1 Play the photograph back and press OK .
- 2 Select [Rotate] and press OK .
- 3 Press Δ to rotate the image counterclockwise, ∇ to rotate it clockwise; the image rotates each time the button is pressed.
 - Press OK to save settings and exit.
 - The rotated image is saved in its current orientation.
 - Movies, 3D photos, and protected images can not be rotated.



Tips

If [On] is selected for R (P. 111) in the \square (playback) menu, images will be displayed in the new orientation during playback.

Slideshow

This function displays images stored on the card one after another.

- 1 Press **OK** during playback and select the slideshow option.

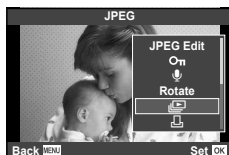

- 2 Adjust settings.

Start	Start the slideshow. Images are displayed in order, starting with the current picture.
BGM	Set BGM (4 types) or turn BGM [Off].
Effect*	Choose the transition between frames.
Slide	Set type of slideshow to execute.
Slide Interval	Choose the length of time each slide is displayed from 2 to 10 seconds.
Movie Interval	Select [Full] to include full-length movie clips in the slideshow, [Short] to include only the opening portion of each clip.

* The only effect available for movies is [Fade].

- 3 Select [Start] and press **OK**.
 - The slideshow will start.
 - Press **OK** to stop the slideshow.

Volume

Press **△▽** during the slideshow to adjust the overall volume of the camera speaker.
Press **<|>** to adjust the balance between the background music and the sound recorded with photographs or movies.

Editing still images

Recorded images can be edited and saved as new images.

- 1 Display the image to be edited and press **OK**.
 - [RAW Data Edit] is displayed if the picture is a RAW image, [JPEG Edit] if it is a JPEG image. If the image was recorded in RAW+JPEG format, the copy that will be edited is determined by your choice of [Edit] option.
- 2 Select [RAW Data Edit] or [JPEG Edit] and press **OK**.

RAW Data Edit	Create a JPEG copy of a RAW image. The JPEG copy is processed using the settings currently stored in the camera. Adjust camera settings before choosing this option.
JPEG Edit	<p>Choose from the following options: [Shadow Adj]: Brightens a dark backlit subject. [Redeye Fix]: Reduces the red-eye phenomenon during flash shooting. [C]: Use the main dial to choose the size of the crop and $\Delta \nabla \triangleleft \triangleright$ to position the crop.</p>  <p>[Aspect]: Changes the aspect ratio of images from 4:3 (standard) to [3:2], [16:9], [1:1], or [3:4]. After changing the aspect ratio, use the arrow pad to specify the trimming position. [Black & White]: Creates black and white images. [Sepia]: Creates sepia-toned images. [Saturation]: Sets the color depth. Adjust the color saturation checking the picture on the screen. [S]: Converts the image file size to 1280 × 960, 640 × 480, or 320 × 240. Images with an aspect ratio other than 4:3 (standard) are converted to the closest image file size. [e-Portrait]: Makes skin look smooth and translucent. You may not be able to compensate depending on the image if face detection fails.</p>

! Cautions

- Movies and 3D photos can not be edited.
- Red-eye correction may not work depending on the image.
- Editing of a JPEG image is not possible in the following cases:
 - When an image is recorded in RAW, when an image is processed on a PC, when there is not enough space in the card memory, when an image is recorded on another camera.
- When resizing (**S**) an image, you cannot select a larger number of pixels than was originally recorded.
- [C] and [Aspect] can only be used to edit images with an aspect ratio of 4:3 (standard).

Image overlay

Up to 3 frames of RAW images taken with the camera can be overlaid and saved as a separate image. The image is saved with the record mode set at the time the image is saved. (If [RAW] is selected, the copy will be saved in [L+N+RAW] format.)

- 1 With a RAW image displayed during playback, press **OK** and select [Image Overlay].
- 2 Select the number of images in the overlay and press **OK**.
- 3 Use **Δ ▽ ◀ ▶** to select the RAW images that will be used in the overlay and press **OK** to select.
 - When you have selected the number of images specified in Step 2, the overlay will be displayed.
- 4 Adjust gain.
 - Use **◀ ▶** to select an image and use **Δ ▽** to adjust gain.
 - Gain can be adjusted in the range 0.1–2.0. Check the results in the monitor.

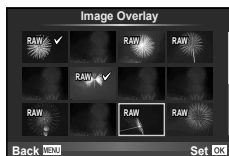

- 5 Press **OK**. A confirmation dialog will be displayed; select [Yes] and press **OK**.

Tips

To overlay 4 or more frames, save the overlay image as a RAW file and use [Image Overlay] repeatedly.

Audio recording

Add an audio recording (up to 30 sec. long) to the current photograph.

- 1 Display the image to which you want to add an audio recording and press **OK**.
 - Audio recording is not available with protected images.
 - Audio recording is also available in the playback menu.
- 2 Select [**🎤**] and press **OK**.
 - To exit without adding a recording, select [No].
- 3 Select [**🎤 Start**] and press **OK** to begin recording.
- 4 Press **OK** to end recording.
 - Images with audio recordings are indicated by a  icon.
 - To delete a recording, select [Erase] in Step 2.

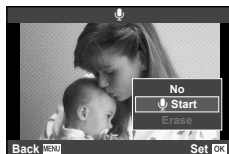
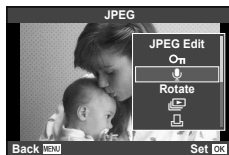

Viewing camera images on TV

Use the AV cable provided with the camera to playback recorded images on your TV. Connect the camera to an HD TV using an HDMI cable (available from third-party suppliers) to view high-quality images on a TV screen.

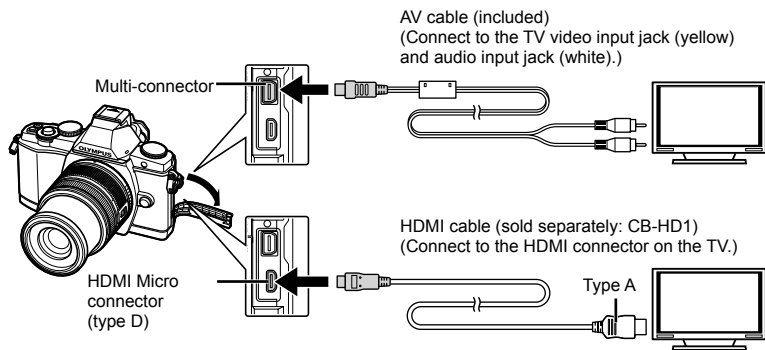

1 Use the cable to connect the camera to the TV.

- Adjust settings on the TV before connecting the camera.
- Choose the camera video mode before connecting the camera via an A/V cable. [Video Out] (P. 87)

2 Choose the TV input channel.

- The camera monitor turns off when the cable is connected.
- Press the  button when connecting via an AV cable.

! Cautions



- For details on changing the input source of the TV, refer to the TV's instruction manual.
- Depending on the TV's settings, the displayed images and information may become cropped.
- If the camera is connected using both an A/V and HDMI cable, it will assign priority to HDMI.
- If the camera is connected via an HDMI mini cable, you will be able to choose the digital video signal type. Choose a format that matches the input format selected with the TV. [HDMI] (P. 87)

1080i	Priority is given to 1080i HDMI output.
720p	Priority is given to 720p HDMI output.
480p/576p	480p/576p HDMI output. 576p is used when [PAL] is selected for [Video Out] (P. 87).

- You cannot shoot pictures or movies when the HDMI cable is connected.
- Do not connect the camera to other HDMI output devices. Doing so may damage the camera.
- HDMI output is not performed while connected via USB to a computer or printer.

Using the TV remote control

The camera can be operated by a TV remote control when connected to a TV that supports HDMI control.

- 1** Select [HDMI] in  Custom Menu (P. 87) tab .
- 2** Select [HDMI Control] and choose [On].
- 3** Operate the camera by using the TV remote control.
 - You can operate the camera by following the operation guide displayed on the TV.
 - During single-frame playback, you can display or hide the information display by pressing the "Red" button, and display or hide the index display by pressing the "Green" button.
 - Some televisions may not support all features.

6 Sending and receiving images

The optional OLYMPUS PENPAL can be used to upload pictures to, and receive pictures from, Bluetooth devices or other cameras connected to an OLYMPUS PENPAL. Visit the OLYMPUS website for more information on Bluetooth devices. Before sending or receiving images, select [On] for [🔌/🗨 Menu Display] > [🗨 Menu Display] to make the accessory port menu accessible.

Sending images

Resize and upload JPEG images to another device. Before sending images, make sure that the receiving device is set to the mode for receiving data.

1 Display the picture you wish to send full frame and press **OK**.

2 Select [Send A Picture] and press **OK**.

- Select [Search] and press **OK** in the next dialog. Bluetooth devices in range, or in [Address Book] will be displayed.



3 Select the destination and press **OK**.

- The image will be uploaded to the receiving device.
- If prompted to provide a PIN code, enter 0000 and press **OK**.



Receiving images/adding a host

Connect to the transmitting device and download JPEG images.

1 Select [OLYMPUS PENPAL Share] in the **A** tab of the accessory port menu (P. 95).

2 Select [Please Wait] and press **OK**.



- Perform operations for sending images on the sending device.
- Transmission will start and a [Receive Picture Request] dialog will be displayed.

3 Select [Accept] and press **OK**.

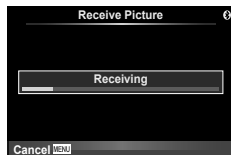
- The image will be downloaded to the camera.
- If prompted to provide a PIN code, enter 0000 and press **OK**.





Tips



To resize images to be transmitted or choose how long the camera searches for a destination.   OLYMPUS PENPAL Share] (P. 95)

Editing the address book

The OLYMPUS PENPAL can store host information. You can assign names to hosts or delete host information.

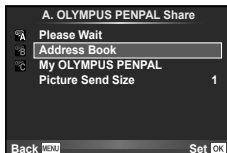
- 1 Select [OLYMPUS PENPAL Share] in the  tab of the accessory port menu (P. 95).
 - Press  and select [Address Book].





- 2 Select [Address List] and press .
 - The names of existing hosts are listed.
- 3 Select the host you wish to edit and press .

Deleting hosts





Select [Yes] and press .

Editing host information

Press  to display host information. To change the host name, press  again and edit the current name in the rename dialog.

Creating albums

Your favorite JPEG pictures can be resized and copied to an OLYMPUS PENPAL.

- 1 Display the picture you wish to copy full frame and press .
- 2 Select [ → PENPAL] and press .
 - To copy images from an OLYMPUS PENPAL to the memory card, select [PENPAL → ] and press .



Tips

Choosing the size at which images are copied. [Picture Copy Size] (P. 95)/
Copying all images from the memory card. [Copy All] (P. 95)/
Deleting or formatting albums. [Album Mem. Setup] (P. 95)/
Removing protection from all images in the album. [Reset Protect] (P. 95)/
Viewing album status (amount of memory remaining). [Album Mem. Usage] (P. 95)

Cautions

- The OLYMPUS PENPAL can be used only in the region in which it was purchased. Depending on the areas, the usage may infringe the wave regulations and may be subject to its penalty.

7 Using OLYMPUS Viewer 2

Windows

- 1 Insert the supplied CD in a CD-ROM drive.

Windows XP

- A "Setup" dialog will be displayed.

Windows Vista/Windows 7

- An Autorun dialog will be displayed. Click "OLYMPUS Setup" to display the "Setup" dialog.



⚠ Caution

- If the "Setup" dialog is not displayed, select "My Computer" (Windows XP) or "Computer" (Windows Vista/Windows 7) from the start menu. Double-click the CD-ROM (OLYMPUS Setup) icon to open the "OLYMPUS Setup" window and then double-click "LAUNCHER.EXE".
- If a "User Account Control" dialog is displayed, click "Yes" or "Continue".

- 2 Follow the on-screen instructions on your computer.

⚠ Caution

- If nothing is displayed on the camera screen even after connecting the camera to the computer, the battery may be exhausted. Use a full-charged battery.

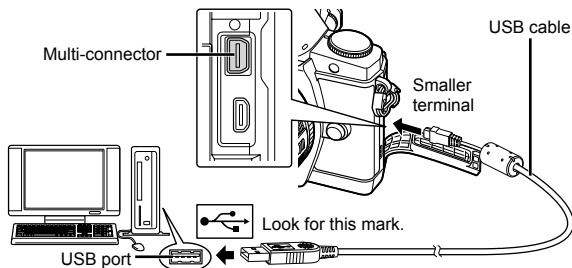

⚠ Caution

- When the camera is connected to another device via USB, a message will be displayed prompting you to choose a connection type. Select [Storage].

- 3 Register your Olympus product.

- Click the "Registration" button and follow the on-screen instructions.

- 4 Install OLYMPUS Viewer 2.

- Check the system requirements before beginning installation.
- Click the "OLYMPUS Viewer 2" button and follow the on-screen instructions to install the software.

OLYMPUS Viewer 2	
Operating System	Windows XP (Service Pack 2 or later)/Windows Vista/ Windows 7
Processor	Pentium 4 1.3 GHz or better (Pentium D 3.0 GHz or better required for movies)
RAM	1 GB or more (2 GB or more recommended)
Free Hard Drive Space	1 GB or more
Monitor Settings	1024 × 768 pixels or more Minimum 65,536 colors (16,770,000 colors recommended)

- See online help for information on using the software.

Macintosh

- 1 Insert the supplied CD in a CD-ROM drive.
 - The disk contents should automatically be displayed in the Finder. If they are not, double-click the CD icon on the desktop.
 - Double-click the “Setup” icon to display the “Setup” dialog.
- 2 Install OLYMPUS Viewer 2.
 - Check the system requirements before beginning installation.
 - Click the “OLYMPUS Viewer 2” button and follow the on-screen instructions to install the software.



OLYMPUS Viewer 2	
Operating System	Mac OS X v10.4.11–v10.7
Processor	Intel Core Solo/Duo 1.5 GHz or better
RAM	1 GB or more (2 GB or more recommended)
Free Hard Drive Space	1 GB or more
Monitor Settings	1024 × 768 pixels or more Minimum 32,000 colors (16,770,000 colors recommended)

- Other languages can be selected from the language combo box. For information on using the software, see online help.

Copying pictures to a computer without OLYMPUS Viewer 2

Your camera supports the USB Mass Storage Class. You can transfer images to a computer by connecting the camera to the computer with the provided USB cable. The following operating systems are compatible with the USB connection:

Windows: Windows XP Home Edition/
Windows XP Professional/
Windows Vista/Windows 7

Macintosh: Mac OS X version 10.3 or later

- 1 Turn the camera off and connect it to the computer.
 - The location of the USB port varies with the computer. For details, refer to your computer's manual.
- 2 Turn on the camera.
 - The selection screen for the USB connection is displayed.
- 3 Press $\Delta \nabla$ to select [Storage]. Press \odot .

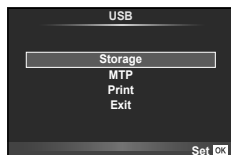

- 4 The computer recognizes the camera as a new device.

! Cautions

- If you are using Windows Photo Gallery for Windows Vista or Windows 7, choose [MTP] in Step 3.
- Data transfer is not guaranteed in the following environments, even if your computer is equipped with a USB port.
 - Computers with a USB port added by means of an extension card, etc.
 - Computers without a factory-installed OS and home-built computers
- Camera controls can not be used while the camera is connected to a computer.
- If the dialog shown in Step 2 is not displayed when the camera is connected, select [Auto] for [USB Mode] (P. 88) in the camera custom menus.

8 Printing pictures

Print reservation (DPOF*)

You can save digital “print orders” to the memory card listing the pictures to be printed and the number of copies of each print. You can then have the pictures printed at a print shop that supports DPOF or print the pictures yourself by connecting the camera directly to a DPOF printer. A memory card is required when creating a print order.

* DPOF (Digital Print Order Format) is a standard for recording the data that a printer or print service requires to automatically print pictures.

Creating a print order

1 Press **OK** during playback and select **[]**.

2 Select **[]** or **[ALL]** and press **OK**.

Individual pictures

Press **<>** to select the frame that you want to set as print reservation, then press **Δ ∇** to set the number of prints.

- To set print reservation for several pictures, repeat this step. Press **OK** when all the desired pictures have been selected.

All pictures

Select **[ALL]** and press **OK**.

3 Select the date and time format and press **OK**.

No	The pictures are printed without the date and time.
Date	The pictures are printed with the shooting date.
Time	The pictures are printed with the shooting time.

4 Select **[Set]** and press **OK**.

! Cautions

- The camera can not be used to modify print orders created with other devices. Creating a new print order deletes any existing print orders created with other devices.
- Print orders can not include 3D photos, RAW images, or movies.

Removing all or selected pictures from the print order

You can reset all print reservation data or just the data for selected pictures.

1 Press **OK** during playback and select **[]**.

2 Select **[]** and press **OK**.

- To remove all pictures from the print order, select **[Reset]** and press **OK**.
To exit without removing all pictures, select **[Keep]** and press **OK**.

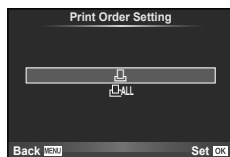

- 3 Press \triangleleft \triangleright to select images you wish to remove from the print order.
 - Use ∇ to set the number of prints to 0. Press OK once you have removed all the desired pictures from the print order.
- 4 Select the date and time format and press OK .
 - This setting is applied to all frames with print reservation data.
- 5 Select [Set] and press OK .

Direct printing (PictBridge)

By connecting the camera to a PictBridge-compatible printer with the USB cable, you can print out recorded pictures directly.

- 1 Connect the camera to the computer using the supplied USB cable and turn the camera on.

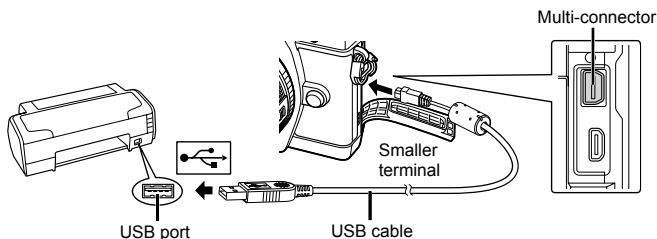

- Use a fully charged battery for printing.
- When the camera is turned on, a dialog should be displayed in the monitor prompting you to choose a host. If it is not, select [Auto] for [USB Mode] (P. 88) in the camera custom menus.

- 2 Use \triangle ∇ to select [Print].
 - [One Moment] will be displayed, followed by a print-mode selection dialog.
 - If the screen is not displayed after a few minutes, disconnect the USB cable and start again from Step 1.

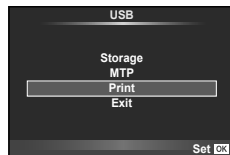

Proceed to “Custom printing” (P. 83).

! Cautions

- 3D photos, RAW images, and movies can not be printed.

Easy printing

Use the camera to display the picture you wish to print before connecting the printer via the USB cable.

- 1 Use $\triangleleft \triangleright$ to display the pictures you want to print on the camera.
- 2 Press \triangleright .
 - The picture selection screen appears when printing is completed. To print another picture, use $\triangleleft \triangleright$ to select the image and press \odot .
 - To exit, unplug the USB cable from the camera while the picture selection screen is displayed.

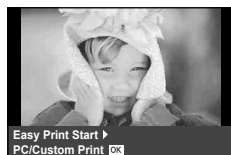

Custom printing

- 1 Follow the operation guide to set a print option.

Selecting the print mode

Select the type of printing (print mode). The available print modes are as shown below.

Print	Prints selected pictures.
All Print	Prints all the pictures stored in the card and makes one print for each picture.
Multi Print	Prints multiple copies of one image in separate frames on a single sheet.
All Index	Prints an index of all the pictures stored in the card.
Print Order	Prints according to the print reservation you made. If there is no picture with print reservation, this is not available.

Setting the print paper items

This setting varies with the type of printer. If only the printer's STANDARD setting is available, you cannot change the setting.

Size	Sets the paper size that the printer supports.
Borderless	Selects whether the picture is printed on the entire page or inside a blank frame.
Pics/sheet	Selects the number of pictures per sheet. Displayed when you have selected [Multi Print].

Selecting pictures you want to print

Select pictures you want to print. The selected pictures can be printed later (single-frame reservation) or the picture you are displaying can be printed right away.



Print (OK)	Prints the currently displayed picture. If there is a picture that [Single Print] reservation has already been applied to, only that reserved picture will be printed.
Single Print (→)	Applies print reservation to the currently displayed picture. If you want to apply reservation to other pictures after applying [Single Print], use <←> to select them.
More (↓)	Sets the number of prints and other items for the currently displayed picture, and whether or not to print it. For operation, refer to "Setting printing data" in the next section.

Setting printing data

Select whether to print printing data such as the date and time or file name on the picture when printing. When the print mode is set to [All Print] and [Option Set] is selected, the following options appears.

	Sets the number of prints.
Date	Prints the date and time recorded on the picture.
File Name	Prints the file name recorded on the picture.
	Trims the picture for printing. Use the dial to choose the crop size and $\Delta \nabla \triangleleft \triangleright$ to position the crop.

- 2** Once you have set the pictures for printing and printing data, select [Print], then press **OK**.

- To stop and cancel printing, press **OK**. To resume printing, select [Continue].

■ Cancelling printing

To cancel printing, highlight [Cancel] and press **OK**. Note that any changes to the print order will be lost; to cancel printing and return to the previous step, where you can make changes to the current print order, press **MENU**.



9 Camera setup

Setup Menu



Use the Setup Menu to set the basic camera functions. For details on using the menu lists, see “Using the menus” (P. 26).



Option	Description	
(Date/time setting)	Set the camera clock.	9
(Changing the display language)	You can change the language used for the on-screen display and error messages from English to another language.	—
(Monitor brightness adjustment)	<p>You can adjust the brightness and color temperature of the monitor. Color temperature adjustment will affect only the monitor display during playback. Use <math>\triangleleft/\triangleright</math> to highlight (color temperature) or (brightness) and \triangle/∇ to adjust the value.</p> <p>Press the INFO button to switch between [Natural] and [Vivid] monitor color display.</p>	—
Rec View	<p>Choose whether pictures are displayed immediately after shooting and for how long. This is useful for making a brief check of the picture you have just taken. Pressing the shutter button halfway while checking the picture lets you resume shooting immediately.</p> <p>[0.3sec]–[20sec]: Selects the number of seconds to display each picture.</p> <p>[Off]: The picture being recorded to the card is not displayed.</p> <p>[Auto]: Displays the image being recorded, and then switches to playback mode. This is useful for erasing a picture after checking it.</p>	—
Menu Display	Choose whether to display the custom menus or accessory port menu.	86
Firmware	Your product's firmware version will be displayed. When you make inquiries about your camera or accessories or when you want to download software, you will need to state which version of each of the products you are using.	—

Camera settings can be customized using the custom and accessory menus. The  Custom menu is used to fine-tune camera settings. The  Accessory Port menu is used to adjust settings for accessory port devices.



Before Using the Custom/Accessory Port Menus

The Custom and Accessory Port menus are only available when the appropriate option is selected for the /  Menu Display] item in the setup menu.  "Setup Menu" (P. 85)



Custom Menu options

AF/MF

MENU →  → 

Option	Description	
AF Mode	Choose the AF mode.	43
Full-time AF	If [On] is selected, the camera will continue to focus even when the shutter button is not pressed halfway.	—
AEL/AFL	Customize AF and AE lock.	93
Reset Lens	When set to [On], this resets the focus of the lens (infinity) each time the power is turned off.	—
BULB/TIME Focusing	Normally focus locks during the exposure when manual focus (MF) is selected. Select [On] to allow focusing using the focus ring.	—
Focus Ring	You can customize how the lens adjusts to the focal point by selecting the rotational direction of the focus ring.	—
MF Assist	Select [On] to automatically magnify the image for precise focus when the focus ring is rotated in manual focus mode.	—
[•••] Set Home	Choose the AF target position that will be saved as the home position. [HP] appears in the AF target selection display while you choose a home position.	—
AF Illuminat.	Select [Off] to disable the AF illuminator.	—
 Face Priority	The camera gives priority to the faces or pupils of human portrait subjects during focusing. The camera zooms in on faces during close-up playback.	46

Button/Dial

MENU →  → 

Option	Description	
Button Function	Choose the function assigned to the selected button.	—
	[Fn1] Function], [Fn2] Function], [C] Function], [D] Function], [V] Function]	93
	[A/B] Function], [BFn1] Function], [BFn2] Function], [L-Fn] Function]	93, 94

Button/Dial

MENU → →

Option	Description	
Dial Function	Choose the roles played by the main and sub dials. You can also use the MENU button to choose dial rotation and cursor movement directions.	—
Dial Direction	Choose the direction in which the dial is rotated in increase or decrease shutter speed and aperture.	—

Release/

MENU → →

Option	Description	
RIs Priority S	If [On] is selected, the shutter can be released even when the camera is not in focus. This option can be set separately for S-AF (P. 43) and C-AF (P. 43) modes.	—
RIs Priority C		
L fps	Choose the frame advance rates for and . Figures are the approximate maximums.	56
H fps		
+ IS Off	If [On] is selected, image stabilization will turn [OFF] during sequential shooting.	—
Half Way RIs With IS	Select [On] to enable image stabilization when the shutter button is pressed halfway.	—

Disp//PC

MENU → →

Option	Description																																			
HDMI	[HDMI Out]: Selecting the digital video signal format for connecting to a TV via an HDMI mini-cable. [HDMI Control]: Select [On] to allow the camera to be operated using remotes for TVs that support HDMI control.	74																																		
Video Out	Choose the video standard ([NTSC] or [PAL]) used in your country or region.	74																																		
Control Settings	Choose the controls displayed in each shooting mode. <table border="1" data-bbox="298 895 833 1118"> <thead> <tr> <th rowspan="2">Controls</th> <th colspan="4">Shooting mode</th> </tr> <tr> <th>P/A/S/M</th> <th>IAUTO</th> <th>ART</th> <th>SCN</th> </tr> </thead> <tbody> <tr> <td>Live Control (P. 24)</td> <td>On/Off</td> <td>On/Off</td> <td>On/Off</td> <td>On/Off</td> </tr> <tr> <td>Live SCP (P. 22)</td> <td>On/Off</td> <td>On/Off</td> <td>On/Off</td> <td>On/Off</td> </tr> <tr> <td>Live Guide (P. 21)</td> <td>—</td> <td>On/Off</td> <td>—</td> <td>—</td> </tr> <tr> <td>Art Menu</td> <td>—</td> <td>—</td> <td>On/Off</td> <td>—</td> </tr> <tr> <td>Scene Menu</td> <td>—</td> <td>—</td> <td>—</td> <td>On/Off</td> </tr> </tbody> </table>	Controls	Shooting mode				P/A/S/M	IAUTO	ART	SCN	Live Control (P. 24)	On/Off	On/Off	On/Off	On/Off	Live SCP (P. 22)	On/Off	On/Off	On/Off	On/Off	Live Guide (P. 21)	—	On/Off	—	—	Art Menu	—	—	On/Off	—	Scene Menu	—	—	—	On/Off	39
Controls	Shooting mode																																			
	P/A/S/M	IAUTO	ART	SCN																																
Live Control (P. 24)	On/Off	On/Off	On/Off	On/Off																																
Live SCP (P. 22)	On/Off	On/Off	On/Off	On/Off																																
Live Guide (P. 21)	—	On/Off	—	—																																
Art Menu	—	—	On/Off	—																																
Scene Menu	—	—	—	On/Off																																
Info Settings	Choose the information displayed when the INFO button is pressed. [] Info: Choose the information displayed in full frame playback. [LV-Info]: Choose the information displayed when the camera is in shooting mode. [] Settings: Choose the information displayed in index and calendar playback.	39, 40, 69																																		
Displayed Grid	Display a framing grid in the monitor.	—																																		

Option	Description	
Picture Mode Settings	Display only the selected picture mode when the live control or super control panel is used to select a picture mode.	—
Histogram Settings	[Highlight]: Choose the lower bound for the highlight display. [Shadow]: Choose the upper bound for the shadow display.	40
Mode Guide	Choose [On] to display help for the selected mode when the mode dial is rotated to a new setting.	12
Live View Boost	If [On] is selected, priority will be given to making images clearly visible; the effects exposure compensation and other settings will not be visible in the monitor.	—
Art LV Mode	[mode1]: The filter effect is always displayed. [mode2]: Filter effects are not visible in the monitor while the shutter button is pressed halfway. Choose for a smooth display.	—
LV Close Up Mode	[mode1]: Pressing the shutter button halfway cancels zoom. [mode2]: Zoom is not cancelled when the shutter button is pressed halfway.	45
Info Off	Choose how long information is displayed.	—
Backlit LCD	If no operations are performed for the selected period, the backlight will dim to save battery power. The backlight will not dim if [Hold] is selected.	—
Sleep	The camera will enter sleep (energy saving) mode if no operations are performed for the selected period. The camera can be reactivated by pressing the shutter button halfway.	—
Auto Power Off	Choose the delay before the camera turns off automatically.	—
■) (Beep sound)	When set to [Off], you can turn off the beep sound that is emitted when the focus locks by pressing the shutter button.	—
USB Mode	Choose a mode for connecting the camera to a computer or printer. Choose [Auto] to display USB mode options every time the camera is connected.	—

Option	Description	
EV Step	Choose the size of the increments used when selecting shutter speed, aperture, exposure compensation, and other exposure parameters.	—
Metering	Choose a metering mode according to the scene.	48
AEL Metering	Choose the metering method used for AE lock (P. 48). [Auto]: Use the currently selected metering method.	—
ISO	Set ISO sensitivity.	55
ISO Step	Select the increments available for choosing ISO sensitivity.	—
ISO-Auto Set	Choose the upper limit and default value used for ISO sensitivity when [Auto] is selected for [ISO]. [High Limit]: Choose the upper limit for auto ISO sensitivity selection. [Default]: Choose the default value for auto ISO sensitivity selection.	—

Option	Description	👉
ISO-Auto	Choose the shooting modes in which [Auto] ISO sensitivity is available. [P/A/S]: Auto ISO sensitivity selection is available in all modes except M . ISO sensitivity is fixed at ISO 200 in mode M . [All]: Auto ISO sensitivity selection is available in all modes.	—
BULB/TIME Timer	Choose the maximum exposure for bulb and time photography.	—
Live BULB	Choose the display interval during shooting. Some restrictions apply. The frequency drops at high ISO sensitivities. Choose [Off] to disable the display. Tap the monitor or press the shutter button halfway to refresh the display.	—
Live TIME		—
Anti-shock [⚡]	Choose the delay between the shutter button being pressed and the shutter being released. This diminishes camera shake caused by vibrations. This feature is useful in situations such as microscope photography and astrophotography. It is also useful for sequential shooting (P. 56) and self timer photography (P. 56).	—

⚙️ Custom

Option	Description	👉
⚡ X-Sync.	Choose the shutter speed used when the flash fires.	109
⚡ Slow Limit	Choose the slowest shutter speed available when a flash is used.	109
📷+📷	When set to [On], it will be added to the exposure compensation value and flash intensity control will be performed.	47, 69

📷 Color/WB

Option	Description	👉
Noise Reduct.	This function reduces the noise that is generated during long exposures. [Auto]: Noise reduction is only performed at slow shutter speeds. [On]: Noise reduction is performed with every shot. [Off]: Noise reduction off. • Noise reduction requires about twice the time needed to record the image. • Noise reduction turns off automatically during sequential shooting. • This function may not work effectively with some shooting conditions or subjects.	59
Noise Filter	Choose the amount of noise reduction performed at high ISO sensitivities.	—
WB	Choose the white balance mode.	50
All [WB?]	[All Set]: Use the same white balance compensation in all modes except [CWB]. [All Reset]: Set white balance compensation for all modes except [CWB] to 0.	—

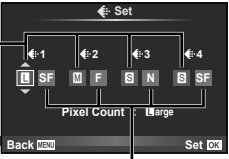
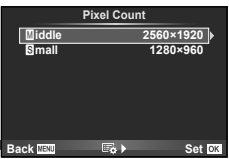
Option	Description	
WB AUTO Keep Warm Color	Select [Off] to eliminate "warm" colors from pictures taken under incandescent lighting.	—
⚡+WB	Adjust white balance for use with a flash.	—
Color Space	You can select how colors are reproduced on the monitor or printer.	—
Shading Comp.	Choose [On] to correct peripheral illumination according to the type of lens. <ul style="list-style-type: none"> • Compensation is not available for teleconverters or extension tubes. • Noise may be visible at the edges of photographs taken at high ISO sensitivities. 	—
☰- Set	<p>The record mode for JPEG photographs can be selected from four combinations of image size and compression rate. The camera offers a choice of three sizes and four compression rates for each combination.</p> <div style="border: 1px solid black; padding: 5px;"> <p>Modifying JPEG record modes</p> <ol style="list-style-type: none"> Use ◀▶ to select a combination ([☰-1] – [☰-4]) and use △▽ to change. Press OK.  <p style="text-align: center;">Number of pixels Compression rate</p> </div>	54
Pixel Count	<p>Choose the pixel count for [M]- and [S]-size images.</p> <div style="border: 1px solid black; padding: 5px;"> <ol style="list-style-type: none"> Select [Pixel Count] in the ☰ Custom Menu tab ☰. Select [Middle] or [Small] and press ▶. Choose a pixel count and press OK.  </div>	54

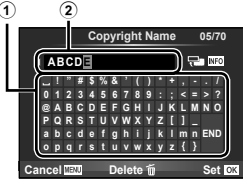

Option	Description	
Quick Erase	If [On] is selected, pressing the  button in the playback display will immediately delete the current image.	—
RAW+JPEG Erase	<p>Choose the action performed when a photograph recorded at a setting of RAW+JPEG is erased in single-frame playback (P. 17).</p> <p>[JPEG]: Only the JPEG copy is erased. [RAW]: Only the RAW copy is erased. [RAW+JPEG]: Both copies are erased.</p> <ul style="list-style-type: none"> • Both the RAW and JPEG copies are deleted when selected images are deleted or when [All Erase] (P. 70) is selected. 	54

Option	Description	👉
File Name	<p>[Auto]: Even when a new card is inserted, the file numbers are retained from the previous card. File numbering continues from the last number used or from the highest number available on the card.</p> <p>[Reset]: When you insert a new card, the folder numbers starts at 100 and the file name starts at 0001. If a card containing images is inserted, the file numbers start at the number following the highest file number on the card.</p>	—
Edit Filename	<p>Choose how image files are named by editing the portion of the filename highlighted below in gray.</p> <p>sRGB: Pmdd0000.jpg _____ Pmdd</p> <p>AdobeRGB: _mdd0000.jpg _____ mdd</p>	—
Priority Set	Choose the default selection ([Yes] or [No]) for confirmation dialogs.	—
dpi Setting	<p>Choose the print resolution.</p> <p>[Auto]: Print resolution is selected automatically according to image size.</p> <p>[Custom]: Press ▷ to choose a print resolution.</p>	—
Copyright Settings	<p>Add the names of the photographer and copyright holder to new photographs. Names can be up to 63 characters long.</p> <p>[Copyright Info.]: Select [On] to include the names of the photographer and copyright holder in the Exif data for new photographs.</p> <p>[Artist Name]: Enter the name of the photographer.</p> <p>[Copyright Name]: Enter the name of the copyright holder.</p> <div data-bbox="301 765 829 1118" style="border: 1px solid gray; padding: 10px;"> <p>1) Highlight a character ① and press OK to add the highlighted character to the name ②.</p> <p>2) Repeat Step 1 to complete the name, then highlight [END] and press OK.</p> <ul style="list-style-type: none"> To delete a character, press the INFO button to place the cursor in the name area ②, highlight the character, and press ⏏. </div> 	—

- OLYMPUS does not accept liability for damages arising from disputes involving the use of [Copyright Settings]. Use at your own risk.







Movie

MENU → ⚙️ → 📷

Option	Description	👉
 Mode	Choose a movie record mode. This option can also be selected using the live control.	67
Movie+Still	Choose [On] to record a photograph when movie recording ends.	96
Movie 	Choose [Off] to record silent movies. This option can also be selected using the live control.	68
Movie Effect	Selecting [Off] disables movie effects.	67
Wind Noise Reduction	Reduce wind noise during recording.	—
Recording Volume	Adjust microphone sensitivity according to the distance to your subject.	—



Built-In EVF

MENU → ⚙️ → 📷

Option	Description	👉
Built-in EVF Style	Choose the viewfinder display style.	—
 Info Settings	Like the monitor, the viewfinder can be used to display histograms and highlights and shadows.	—
 Displayed Grid	Display a framing grid in the viewfinder. Choose from  ,  ,  , and  .	—
EVF Auto Switch	If [Off] is selected, the viewfinder will not turn on when you put your eye to the viewfinder. Use the  button to choose the display.	—
Frame Rate	Choose the viewfinder refresh rate. Select [High] to reduce display lag. Display quality may drop under some types of lighting, including fluorescent lamps.	20
EVF Adjust	Adjust viewfinder brightness and hue.	—

Utility

MENU → ⚙️ → 📷

Option	Description	👉
Pixel Mapping	The pixel mapping feature allows the camera to check and adjust the image pickup device and image processing functions.	102
Exposure Shift	Adjust optimal exposure separately for each metering mode. <ul style="list-style-type: none"> This reduces the number of exposure compensation options available in the selected direction. The effects are not visible in the monitor. To make normal adjustments to the exposure, perform exposure compensation (P. 47). 	—
 Warning Level	Choose the battery level at which the  warning is displayed.	30, 31
 Battery Priority	Choose the primary power source when using a power battery holder.	107
Level Adjust	Adjust the angle of the virtual horizon. [Reset]: Restore the factory default angle. [Adjust]: Set the virtual horizon to the camera's current angle.	—

Option	Description	
Touch Screen Settings	Activate the touch screen. Choose [Off] to disable the touch screen.	27
Eye-Fi*	Enable or disable upload when using an Eye-Fi card.	103

* Use in accordance with local regulations. Onboard airplanes and in other locations in which the use of wireless devices is prohibited, remove the Eye-Fi card from the camera or select [Off] for [Eye-Fi]. The camera does not support the “endless” Eye-Fi mode.

■ AEL/AFL

MENU →  →  → [AEL/AFL]

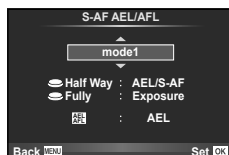

Autofocus and metering can be performed by pressing the button to which AEL/AFL has been assigned. Choose a mode for each focus mode.



AEL/AFL

Mode		Shutter button function				Button function	
		Half-press		Full press		When holding down AEL/AFL	
		Focus	Exposure	Focus	Exposure	Focus	Exposure
S-AF	mode1	S-AF	Locked	–	–	–	Locked
	mode2	S-AF	–	–	Locked	–	Locked
	mode3	–	Locked	–	–	S-AF	–
C-AF	mode1	C-AF start	Locked	Locked	–	–	Locked
	mode2	C-AF start	–	Locked	Locked	–	Locked
	mode3	–	Locked	Locked	–	C-AF start	–
	mode4	–	–	Locked	Locked	C-AF start	–
MF	mode1	–	Locked	–	–	–	Locked
	mode2	–	–	–	Locked	–	Locked
	mode3	–	Locked	–	–	S-AF	–

■ Button Function















MENU →  →  → [Button Function] → [[Fn1] Function]/ [[Fn2] Function]/ [(⊙) Function]/ [[B Fn1] Function]/ [[B Fn2] Function]/ [[L Fn] Function]

The functions that can be assigned to the buttons are listed below. The options available vary from button to button.





B Fn1, **B Fn2**: Choose the function assigned to the buttons on the battery holder.

L Fn: Choose the function assigned to the button on some lenses.

Multi Function	Allows rapid access to the selected function. Choose from [Highlight&Shadow Control], [WB], [Magnify], and [Image Aspect].
ISO	Adjust ISO sensitivity.
WB	Adjust white balance.
	Adjust exposure compensation.
AEL/AFL	Press the button to lock focus and exposure.



 REC	Press the button to record a movie. If movie recording is not currently assigned to a button, movies can be recorded by rotating the mode dial to  and pressing the shutter button.
Preview (electronic)	Aperture is stopped down to the selected value while the button is pressed (P. 58).
 [...]	Choose the AF target.
 Home	Pressing the button selects the AF target position saved with  Set Home (P. 86). The home AF target position is indicated by a  icon. Press the button again to return to AF target mode. If the camera is turned off when the home position is selected, the home position will be reset.
	The camera measures white balance when the button is pressed (P. 51).
MF	Press the button to select manual focus mode. Press the button again to restore the previously selected AF mode.
RAW 	Press the button to toggle between JPEG and RAW+JPEG record modes.
Test Picture	Pictures taken while the button is pressed are displayed in the monitor but are not recorded to the memory card.
Myset1 – Myset4	Pictures shot while the button is pressed will be recorded at the settings selected for [Reset/Myset] (P. 42).
	The button can be used to choose between  and  while the underwater case is attached. Press and hold the button to return to the previous mode. If this option is selected, the FL-LM2 will fire even when not raised.
Live Guide	Press the button to display live guides.
 (Digital Tele-converter)	Press the button to turn digital zoom on or off.
 (Magnify)	Press the button once to display the zoom frame, again to zoom in. Keep the button pressed to cancel zoom.
AF Stop	Stop autofocus.
	Choose a sequential shooting or self timer option.
	Choose a flash mode.
Off	No function is assigned to the button.



Function

The default functions for  and  as assigned by the [Direct Function] option are  and , respectively.



Accessory port menu options

OLYMPUS PENPAL Share

MENU →  → 



Option	Description	
Please Wait	Receive images and add hosts to the address book.	76
Address Book	[Address List]: View the hosts that have been saved to the address book. [New Pairing]: Add a host to the address book. [Search Timer]: Choose how long the camera searches for a host.	77
My OLYMPUS PENPAL	Display information for your OLYMPUS PENPAL, including the name, address, and supported services. Press  to edit the device name.	77
Picture Send Size	Choose the size at which images are transmitted. [Size 1: Small]: Images are sent at a size equivalent to 640 × 480. [Size 2: Large]: Images are sent at a size equivalent to 1920 × 1440. [Size 3: Medium]: Images are sent at a size equivalent to 1280 × 960.	76







OLYMPUS PENPAL Album

MENU →  → 

Option	Description	
Copy All	All images and sound files are copied between the memory card and OLYMPUS PENPAL. Copied images are resized according to the option selected for picture copy size.	77
Reset Protect	Remove protection from all pictures in the OLYMPUS PENPAL album.	77
Album Mem. Usage	Show the number of pictures currently in the album and the number of additional pictures that can be stored at [Size 2: Medium].	77
Album Mem. Setup	[All Erase]: Delete all pictures in the album. [Format Album]: Format the album.	77
Picture Copy Size	Choose the size at which images are copied. [Size 1: Large]: Copied images are not resized. [Size 2: Medium]: Images are copied at a size equivalent to 1920 × 1440.	77

Electronic Viewfinder

MENU →  → 

Option	Description	
EVF Adjust	Adjust the brightness and the color temperature of optional external viewfinders. The selected color temperature is also used in the monitor during playback. Use  to select color temperature () or brightness () and use   to choose from values between [+7] and [-7].	—



Recording movies with the shutter button

If movie recording is not assigned to any button (including the  button), the shutter button can be used to record movies.

- 1 Set the mode dial to .
- 2 Press the shutter button halfway down and focus on what you wish record.
 - When the subject is in focus, the AF confirmation mark lights up.

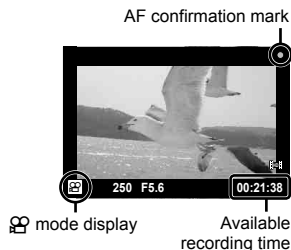



- 3 Press the shutter button all the way to begin recording.
 - **•REC** lights up while both movie and sound are recorded simultaneously.



- 4 Press the shutter button all the way to end recording.

Taking a photograph when recording ends

Select [On] for [Movie+Still] to take a still picture when movie recording is finished. This feature is useful when you want to record a still picture as well as the movie.

- 1 Select [Movie+Still] (P. 92) in  Custom Menu tab .
- 2 Select [On] and press .

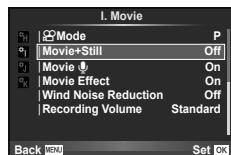

! Cautions

- This option is only available when the shutter button is used to record movies.

Wireless remote control flash photography

External flash units that offer a remote control mode and are designated for use with this camera can be used for wireless flash photography. The camera can independently control a flash mounted on the camera and remote flash units in up to 3 groups. See the documentation provided with the external flash units for details.

- 1 Set the remote flash units to RC mode and place them as desired.
 - Turn each flash unit on, press the MODE button, and select RC mode.
 - Select a channel and group for each flash unit.
- 2 Select [On] for [⚡ RC Mode] in  Shooting menu 2 (P. 111).
 - The super control panel switches to RC mode.
 - You can choose a super control panel display by repeatedly pressing the **INFO** button.
 - Select a flash mode (note that red-eye reduction is not available in RC mode).
- 3 Adjust the settings for each group in the super control panel.

Flash intensity value

Group

- Select the flash control mode and adjust the flash intensity separately for each group. For MANUAL, select the flash intensity.

Choose the role performed by the camera flash.

Flash control mode

Flash intensity mode

Normal flash/Super FP flash

- Switch between normal flash and Super FP flash.

Communication light level

- Set the communication light level to [HI], [MID], or [LO].

Channel

- Set the communication channel to the same channel used on the flash.



- 4 Attach the supplied flash unit and raise the flash head.
 - After confirming that the built-in and remote flash units have charged, take a test shot.

Wireless flash control range

Position the wireless flash units with their remote sensors facing the camera. The following illustration shows the approximate ranges at which the flash units can be positioned. The actual control range varies with local conditions.

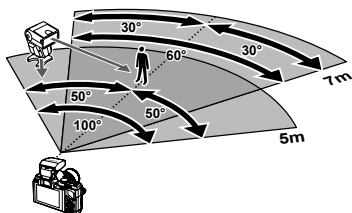

! Cautions

- We recommend using a single group of up to three remote flash units.
- Remote flash units can not be used for second curtain slow synchronization or anti-shock exposures longer than 4 seconds.
- If the subject is too close to the camera, the control flashes emitted by the camera flash may affect exposure (The effect can be moderated by reducing the output of the camera flash using a diffuser or other similar techniques).

Shooting tips and information

The camera does not turn on even when a battery is loaded

The battery is not fully charged

- Charge the battery with the charger.

The battery is temporarily unable to function because of the cold

- Battery performance drops at low temperatures. Remove the battery and warm it by putting it in your pocket for a while.

No picture is taken when the shutter button is pressed

The camera has turned off automatically

- The camera automatically enters sleep mode to reduce the drain on the battery if no operations are performed for a set period of time.  [Sleep] (P. 88)
If no operations are performed for a set time (4 hours) after the camera has entered sleep mode, the camera will turn off automatically.

The flash is charging

- On the monitor, the  mark blinks when charging is in progress. Wait for the blinking to stop, then press the shutter button.

Unable to focus

- The camera can not focus on subjects that are too close to the camera or that are not suited to autofocus (the AF confirmation mark will blink in the monitor). Increase the distance to the subject or focus on a high contrast object at the same distance from the camera as your main subject, compose the shot, and shoot.

Subjects that are difficult to focus on

It may be difficult to focus with auto focus in the following situations.

AF confirmation mark is blinking. These subjects are not focused.



Subject with low contrast



Excessively bright light in center of frame

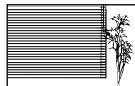

Subject containing no vertical lines

AF confirmation mark lights up but the subject is not focused.



Subjects at different distances

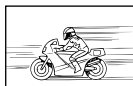

Fast-moving subject



Subject not inside AF area

Noise reduction is activated

- When shooting night scenes, shutter speeds are slower and noise tends to appear in images. The camera activates the noise-reduction process after shooting at slow shutter speeds. During which, shooting is not allowed. You can set [Noise Reduct.] (P. 89) to [Off].

The number of AF targets is reduced.

The number and size of AF targets varies with aspect ratio, group target settings, and the option selected for [Digital Tele-converter].

The date and time has not been set

The camera is used with the settings at the time of purchase

- The date and time of the camera is not set when purchased. Set the date and time before using the camera.  "Setting the date/time" (P. 9)

The battery has been removed from the camera

- The date and time settings will be returned to the factory default settings if the camera is left without the battery for approximately 1 day. The settings will be cancelled more quickly if the battery was only loaded in the camera for a short time before being removed. Before taking important pictures, check that the date and time settings are correct.

Set functions are restored to their factory default settings

When you rotate the mode dial or turn off the power in a shooting mode other than **P**, **A**, **S**, or **M**, functions with changes made to their settings are restored to the factory default settings.

Image taken appears whitish

This may occur when the picture is taken in backlight or semi-backlight conditions. This is due to a phenomenon called flare or ghosting. As far as possible, consider a composition where strong light source is not taken in the picture. Flare may occur even when a light source is not present in the picture. Use a lens hood to shade the lens from the light source. If a lens hood does not have effect, use your hand to shade the lens from the light.  "Interchangeable lenses" (P. 104)

Unknown bright dot(s) appear on the subject in the picture taken

This may be due to stuck pixel(s) on the image pickup device. Perform [Pixel Mapping]. If the problem persists, repeat pixel mapping a few times.











 "Pixel mapping - Checking the image processing functions" (P. 102)









Functions that cannot be selected from menus

Some items may not be selectable from the menus when using the arrow pad.

- Items that cannot be set with the current shooting mode
- Items that cannot be set because of an item that has already been set:
Combination of  and [Noise Reduct.], etc.

Error codes

Monitor indication	Possible cause	Corrective action
 No Card	The card is not inserted, or it cannot be recognized.	Insert a card or insert a different card.
 Card Error	There is a problem with the card.	Insert the card again. If the problem persists, format the card. If the card cannot be formatted, it cannot be used.
 Write Protect	Writing to the card is prohibited.	The card write-protect switch is set to the "LOCK" side. Release the switch. (P. 103)
 Card Full	<ul style="list-style-type: none"> The card is full. No more pictures can be taken or no more information such as print reservation can be recorded. There is no space in the card and print reservation or new images cannot be recorded. 	Replace the card or erase unwanted pictures. Before erasing, download important images to a PC.
	Card cannot be read. Card may not have been formatted.	<ul style="list-style-type: none"> Select [Clean Card], press  and turn off the camera. Remove the card and wipe dry the metallic surface with a soft, dry cloth. Select [Format] ▶ [Yes], and then press  to format the card. Formatting the card erases all data on the card.
 No Picture	There are no pictures on the card.	The card contains no pictures. Record pictures and play back.
 Picture Error	The selected picture cannot be displayed for playback due to a problem with this picture. Or the picture cannot be used for playback on this camera.	Use image processing software to view the picture on a PC. If that cannot be done, the image file is damaged.
 The Image Cannot Be Edited	Pictures taken with another camera cannot be edited on this camera.	Use image processing software to edit the picture.
 Picture Error	Images can not be transferred between devices that are currently receiving or transmitting data.	Increase the amount of memory available on the card, for example by deleting unwanted images, or choose a smaller size for the images being transmitted.

Monitor indication	Possible cause	Corrective action
 °C/°F		Turn off the camera and wait for the internal temperature to cool.
 Internal camera temperature is too high. Please wait for cooling before camera use.	The internal temperature of the camera has risen due to sequential shooting.	Wait a moment for the camera to turn off automatically. Allow the internal temperature of the camera to cool before resuming operations.
 Battery Empty	The battery is drained.	Charge the battery.
 No Connection	The camera is not connected to the computer or printer correctly.	Disconnect the camera and connect it again correctly.
 No Paper	There is no paper in the printer.	Load some paper in the printer.
 No Ink	The printer has run out of ink.	Replace the ink cartridge in the printer.
 Jammed	The paper is jammed.	Remove the jammed paper.
Settings Changed	The printer's paper cassette has been removed or the printer has been manipulated while making settings on the camera.	Do not manipulate the printer while making settings on the camera.
 Print Error	There is a problem with the printer and/or camera.	Turn off camera and printer. Check the printer and remedy any problems before turning the power on again.
 Cannot Print	Pictures recorded on other cameras may not be printed on this camera.	Use a personal computer to print.
The lens is locked. Please extend the lens.	The lens of the retractable lens stays retracted.	Extend the lens. (P. 6)
Please check the status of a lens.	An abnormality has occurred between the camera and the lens.	Turn off the camera, check the connection with the lens, and turn the power on again.

Cleaning and storing the camera

Cleaning the camera

Turn off the camera and remove the battery before cleaning the camera.

Exterior:

- Wipe gently with a soft cloth. If the camera is very dirty, soak the cloth in mild soapy water and wring well. Wipe the camera with the damp cloth and then dry it with a dry cloth. If you have used the camera at the beach, use a cloth soaked in clean water and well wrung.

Monitor and viewfinder:

- Wipe gently with a soft cloth.

Lens:

- Blow dust off the lens with a commercially available blower. For the lens, wipe gently with a lens cleaning paper.

Storage

- When not using the camera for a prolonged period, remove the battery and card. Store the camera in a cool, dry place that is well ventilated.
- Insert the battery periodically and test the camera's functions.
- Remove dust and other foreign matter from the body and rear caps before attaching them.
- Attach the body cap to the camera to prevent dust from getting inside when no lens is attached. Be sure to replace the front and rear lens caps before putting the lens away.
- Clean the camera after use.
- Do not store with insect repellent.

Cleaning and checking the image pickup device

This camera incorporates a dust reduction function to keep dust from getting on the image pickup device and to remove any dust or dirt from the image pickup device surface with ultrasonic vibrations. The dust reduction function operates when the camera is turned on.

The dust reduction function operates at the same time as the pixel mapping, which checks the image pickup device and image processing circuitry. Since dust reduction is activated every time the camera's power is turned on, the camera should be held upright for the dust reduction function to be effective.

Cautions

- Do not use strong solvents such as benzene or alcohol, or a chemically treated cloth.
- Avoid storing the camera in places where chemicals are treated, in order to protect the camera from corrosion.
- Mold may form on the lens surface if the lens is left dirty.
- Check each part of the camera before use if it has not been used for a long time. Before taking important pictures, be sure to take a test shot and check that the camera works properly.

Pixel mapping - Checking the image processing functions

The pixel mapping feature allows the camera to check and adjust the image pickup device and image processing functions. After using the monitor or taking continuous shots, wait for at least one minute before using the pixel mapping function to ensure that it operates correctly.

1 Select [Pixel Mapping] (P. 92) in Custom Menu tab .

2 Press , then press .

- The [Busy] bar is displayed when pixel mapping is in progress. When pixel mapping is finished, the menu is restored.

Cautions

- If you accidentally turn the camera off during pixel mapping, start again from Step 1.

Card basics

Usable cards

In this manual, all storage devices are referred to as “cards.” The following types of SD memory card (commercially available) can be used with this camera: SD, SDHC, SDXC, and Eye-Fi. For the latest information, please visit the Olympus website.



SD card write protect switch

The SD card body has a write protect switch. If you set the switch to the “LOCK” side, you will not be able to write to the card, delete data or format. Return the switch to the unlock position enable writing.

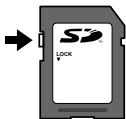

Cautions

- The data in the card will not be erased completely even after formatting the card or deleting the data. When discarding, destroy the card to prevent leakage of personal information.
- Use the Eye-Fi card in compliance with the laws and regulations of the country where the camera is used.
- In locations such as on an airplane, where the Eye-Fi communication is prohibited, remove the Eye-Fi card from the camera, or set [Eye-Fi] (P. 93) to [Off].
- The Eye-Fi card may become hot during use.
- When using an Eye-Fi card, the battery may run out faster.
- When using an Eye-Fi card, the camera may function more slowly.

Formatting the card

Cards formatted on a computer or other camera must be formatted with the camera before they can be used.

All data stored on the card, including protected images, is erased when the card is formatted. When formatting a used card, confirm there are no images that you still want to keep on the card.

1 Select [Card Setup] in shooting menu (P. 111).

2 Select [Format].

3 Select [Yes] and press .

- Formatting is performed.

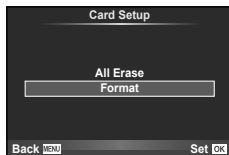

Battery and charger

- Use the single Olympus lithium-ion battery. Use only genuine OLYMPUS rechargeable batteries.
- The camera's power consumption varies widely with usage and other conditions.
- As the following consume a lot of power even without shooting, the battery will be drained quickly.
 - Performing auto focus repeatedly by pressing the shutter button halfway in shooting mode.
 - Displaying images on the monitor for a prolonged period.
 - When connected to a computer or printer.
- When using a drained battery, the camera may turn off without the low battery warning being displayed.
- The battery will not be fully charged at the time of purchase. Charge the battery using the provided charger before use.
- The normal charging time using the provided charger is approximately 4 hours (estimated).
- Do not attempt to use chargers not specifically designated for use with the supplied battery, or to use batteries not specifically designated for use with the supplied charger.

! Cautions

- There is a risk of explosion if the battery is replaced with the incorrect battery type. Dispose of the used battery following the instructions. "Battery Handling Precautions" (P. 119)

Using an optional AC adapter

The camera can be connected to an optional AC-3 AC adapter via a power battery holder (HLD-6). Other adapters can not be used. The power cable supplied with the AC adapter can not be used with other products.

Using your charger abroad

- The charger can be used in most home electrical sources within the range of 100V to 240V AC (50/60Hz) around the world. However, depending on the country or area you are in, the AC wall outlet may be shaped differently and the charger may require a plug adapter to match the wall outlet. For details, ask at your local electrical shop or travel agent.
- Do not use commercially available travel adapters as the charger may malfunction.

Interchangeable lenses

Choose a lens according to the scene and your creative intent. Use lenses designed exclusively for the Micro Four Thirds system and bearing the M. ZUIKO label or the symbol shown at right. With an adapter, you can also use Four Thirds System and OM System lenses.



! Cautions

- When you attach or remove the body cap and lens from the camera, keep the lens mount on the camera pointed downward. This helps prevent dust and other foreign matter from getting inside the camera.
- Do not remove the body cap or attach the lens in dusty places.

- Do not point the lens attached to the camera toward the sun. This may cause the camera to malfunction or even ignite due to the magnifying effect of sunlight focusing through the lens.
- Be careful not to lose the body cap and rear cap.

M.ZUIKO DIGITAL lens specifications

■ Names of parts

- ① Filter mount thread
- ② Zoom ring (zoom lenses only)
- ③ Focus ring
- ④ Mount index
- ⑤ Electrical contacts
- ⑥ Front cap
- ⑦ Rear cap

If the hood is attached to a lens with a decorative ring, rotate the ring to the left.

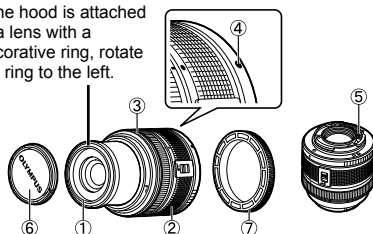

■ Using power zoom lenses with macro functions

Lens operation is determined by the position of the zoom ring.

MACRO button

Zoom ring

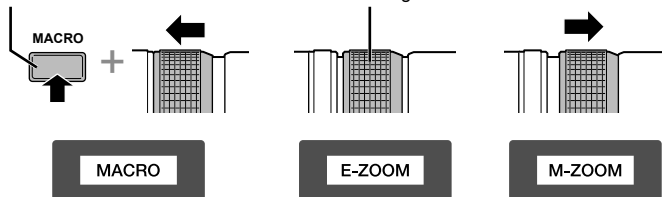

E-ZOOM (Power Zoom)	Rotate the zoom ring for power zoom. Zoom speed is determined by the amount of rotation.
M-ZOOM (Manual Zoom)	Rotate the zoom ring to zoom in and out.
MACRO (Macro Photography)	To photograph subjects at a range of 0.2 to 0.5 m, press the MACRO button and slide the zoom ring forward. Zoom is not available.

- The role of the **L-Fn** button can be selected in the camera custom menu.

■ Lens and camera combinations

Lens	Camera	Attachment	AF	Metering
Micro Four Thirds system lens	Micro Four Thirds system camera	Yes	Yes	Yes
Four Thirds system lens		Attachment possible with mount adapter	Yes ^{*1}	Yes
OM System lenses			No	Yes ^{*2}
Micro Four Thirds system lens	Four Thirds System Camera	No	No	No

*1 [C-AF] and [C-AF+TR] of [AF Mode] cannot be used.

*2 Accurate metering not possible.

■ Main Specifications

Items	14–42 mm II R	40–150 mm R	12–50 mm
Mount	Micro Four Thirds mount		
Focal length	14–42 mm	40–150 mm	12–50 mm
Max. aperture	f/3.5–5.6	f/4.0–5.6	f/3.5–6.3
Image angle	75°–29°	30.3°–8.2°	84°–24°
Lens configuration	7 groups, 8 lenses	10 groups, 13 lenses	9 groups, 10 lenses
	Multilayer film coating		
Iris control	f/3.5–22	f/4.0–22	f/3.5–22
Shooting range (Focal length)	0.25 m–∞ (14–19 mm) 0.3 m–∞ (20–42 mm)	0.9 m–∞	0.35 m–∞ 0.2 m–0.5 m (macro mode)
Focus adjustment	AF/MF switching		
Weight (excluding hood and cap)	113 g	190 g	212 g
Dimensions (Max. diameter × length)	ø56.5×50 mm	ø63.5×83 mm	ø57×83 mm
Filter mount thread diameter	37 mm	58 mm	52 mm

! Cautions

- Edges of pictures may be cut off if more than one filter is used or if a thick filter is used.

Principal Accessories

Mount adapter

Mount adapter allows the camera to be used with lenses that do not conform to the Micro Four Thirds System standard.

■ Four Thirds lens adapter (MMF-3)

The camera requires MMF-3 Four Thirds lens adapter to attach Four Thirds lenses. Some features, such as autofocus, may not be available.

■ OM adapter (MF-2)

Use with existing OLYMPUS OM System lenses. Focus and aperture must be adjusted manually. Image stabilization can be used. Input the focal length of the lens being used in the camera image stabilization settings.

Remote cable (RM-UC1)

Use to reduce camera movement caused by the shutter button during macro or bulb photography. The remote cable attaches via the camera USB connector.

Converter lenses

Converter lenses attach to the camera lens for quick and easy fish-eye or macro photography. See the OLYMPUS website for information on the lenses that can be used.

- Use the appropriate lens attachment for **SCN** mode (📷, 📷, or 📷).

Macro arm light (MAL-1)

Use to illuminate subjects for macro photography, even at ranges at which vignetting would occur with the flash.

Microphone set (SEMA-1)

The microphone can be placed at a distance from the camera to avoid recording ambient sounds or wind noise. Third-party commercial microphones can also be used depending on your creative intent. We recommend that you use the supplied extension cord. (power supplied via ø3.5 mm stereo mini-plug)

Power Battery Holder (HLD-6)

The power battery holder includes grip and power components. The power component supplements the camera battery. It is equipped with a shutter button, a dial, and function buttons for use when the camera is rotated to take pictures in portrait orientation. It can also be used with a dedicated AC adapter (AC-3).





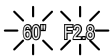
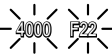
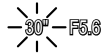
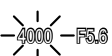
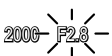
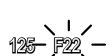





Exposure warning display

If the optimum exposure cannot be obtained when pressing the shutter button halfway, the display will blink on the monitor.



Shooting mode	Warning display example	Status	Action
P	 F2.8	The subject is too dark.	<ul style="list-style-type: none">• Increase the ISO sensitivity.• Use the flash.
	 F22	The subject is too bright.	<ul style="list-style-type: none">• Decrease the ISO sensitivity.• Use a commercially available ND filter (for adjusting the amount of light).
A	 F5.6	The subject is underexposed.	<ul style="list-style-type: none">• Decrease the aperture value.• Increase the ISO sensitivity.
	 F5.6	The subject is overexposed.	<ul style="list-style-type: none">• Increase the aperture value.• Decrease the ISO sensitivity or use a commercially available ND filter (for adjusting the amount of light).
S	 F2.8	The subject is underexposed.	<ul style="list-style-type: none">• Set the shutter speed slower.• Increase the ISO sensitivity.
	 F22	The subject is overexposed.	<ul style="list-style-type: none">• Set the shutter speed faster.• Decrease the ISO sensitivity or use a commercially available ND filter (for adjusting the amount of light).

- The aperture value at the moment when its indication blinks varies with the lens type and focal length of the lens.

Flash modes that can be set by shooting mode

Shooting Mode	Super control panel	Flash Mode	Flash timing	Conditions for firing the flash	Shutter speed limit
P/A		Auto flash	1st curtain	Fires automatically in dark/backlit* conditions	1/30 sec. – 1/250 sec.
		Auto flash (red-eye reduction)			
		Fill-in flash			
		Flash off	—	—	—
	 SLOW	Slow synchronization (red-eye reduction)	1st curtain	Fires automatically in dark/backlit* conditions	60 sec. – 1/250 sec.
		Slow synchronization (1st curtain)			
	 SLOW2	Slow synchronization (2nd curtain)	2nd curtain		
S/M		Fill-in flash	1st curtain		
		Fill-in flash (red-eye reduction)			
		Flash off	—	—	—
	 2nd-C	Fill-in flash/Slow synchronization (2nd curtain)	2nd curtain	Always fires	60 sec. – 1/250 sec.

* When the flash is set to the Super FP mode, it detects backlight and fires with a longer duration than for normal flash before emitting light.

-  **AUTO**,  can be set in **AUTO** mode.

Minimum range (FL-LM2)

The lens may cast shadows over objects close to the camera, causing vignetting, or be too bright even at minimum output.

Lens	Approximate distance at which vignetting occurs
14–42 mm	0.2 m
17 mm	0.2 m
40–150 mm	0.65 m
12–50 mm	0.5 m

- Use optional off-camera flash units to prevent vignetting. To prevent photographs from being overexposed, select mode **A** or **M** and choose a high f-number, or reduce ISO sensitivity.

Flash synchronization and shutter speed

Shooting mode	Flash timing	Upper limit of synchronization timing ^{*1}	Fixed timing when flash fires ^{*2}
P	1/ (lens focal length × 2) or synchronization timing, whichever is slower	1/250	1/60
A			
S	The set shutter speed		—
M			

*1 Can be changed using menu: 1/60 – 1/250  [⚡ X-Sync.] (P. 89)

*2 Can be changed using menu: 30 – 1/250  [⚡ Slow Limit] (P. 89)

External flash shooting

With this camera, you can use one of the separately sold external flash units to achieve a flash suited to your needs. The external flashes communicate with the camera, allowing you to control the camera's flash modes with various available flash control modes, such as TTL-AUTO and Super FP flash.

An external flash unit specified for use with this camera can be mounted on the camera by attaching it to the camera's hot shoe. You can also attach the flash to the flash bracket on the camera using the bracket cable (optional). Refer to the documentation provided with the external flash units as well.

Functions available with external flash units

Optional flash	Flash control mode	GN (Guide number) (ISO100)	RC mode
FL-600R	TTL-AUTO, AUTO, MANUAL, FP TTL AUTO, FP MANUAL	GN36 (85 mm*) GN20 (24 mm*)	✓
FL-300R	TTL-AUTO, MANUAL	GN20 (28 mm*)	✓
FL-14	TTL-AUTO, AUTO, MANUAL	GN14 (28 mm*)	—
RF-11	TTL-AUTO, MANUAL	GN11	—
TF-22		GN22	—

* The focal length of the lens that can be used (Calculated based on 35 mm film camera).

Record mode and file size/number of storable still pictures

The file size in the table is approximate for files with a 4:3 aspect ratio.

Record mode	Number of pixels (Pixel Count)	Compression	File format	File size (MB)	Number of storable still picture*1
RAW	4608×3456	Loss-less compression	ORF	Approx. 17	41
L ^{SF}		1/2.7		Approx. 11	79
L ^F		1/4		Approx. 7.5	114
L ^N		1/8		Approx. 3.5	248
L ^B		1/12		Approx. 2.4	369
M ^{SF}	3200×2400	1/2.7	JPEG	Approx. 5.6	155
M ^F		1/4		Approx. 3.4	257
M ^N		1/8		Approx. 1.7	508
M ^B		1/12		Approx. 1.2	753
M ^{SF}	2560×1920	1/2.7		Approx. 3.2	271
M ^F		1/4	Approx. 2.2	398	
M ^N		1/8	Approx. 1.1	782	
M ^B		1/12	Approx. 0.8	1151	
M ^{SF}	1920×1440	1/2.7	JPEG	Approx. 1.8	476
M ^F		1/4		Approx. 1.3	701
M ^N		1/8		Approx. 0.7	1356
M ^B		1/12		Approx. 0.5	1968
M ^{SF}	1600×1200	1/2.7		Approx. 1.3	678
M ^F		1/4	Approx. 0.9	984	
M ^N		1/8	Approx. 0.5	1906	
M ^B		1/12	Approx. 0.4	2653	
S ^{SF}	1280×960	1/2.7	JPEG	Approx. 0.9	1034
S ^F		1/4		Approx. 0.6	1488
S ^N		1/8		Approx. 0.4	2773
S ^B		1/12		Approx. 0.3	3813
S ^{SF}	1024×768	1/2.7		Approx. 0.6	1564
S ^F		1/4	Approx. 0.4	2260	
S ^N		1/8	Approx. 0.3	4068	
S ^B		1/12	Approx. 0.2	5547	
S ^{SF}	640×480	1/2.7	JPEG	Approx. 0.3	3589
S ^F		1/4		Approx. 0.2	5085
S ^N		1/8		Approx. 0.2	7627
S ^B		1/12		Approx. 0.1	10170

*1 Assumes a 1GB SD card.

⚠ Cautions

- The number of remaining pictures may change according to the subject, whether or not print reservations have been made, and other factors. In certain instances, the number of remaining pictures displayed on the monitor will not change even when you take pictures or erase stored images.
- The actual file size varies according to the subject.
- The maximum number of storable still pictures displayed on the monitor is 9999.
- For the available recording time for movies, see the Olympus website.











Menu directory

*1: Can be added to [Myset].







*2: Default can be restored by selecting [Full] for [Reset].

*3: Default can be restored by selecting [Basic] for [Reset].

Shooting Menu

Tab	Function		Default	*1	*2	*3		
	Card Setup		—				70, 103	
	Reset/Myset		—		✓		42	
	Picture Mode		 Natural	✓	✓	✓	52	
		Still Picture	 N	✓	✓	✓	54	
		Movie	MOV FullHD25P					
	Image Aspect		4:3	✓	✓	✓	55	
	Digital Tele-converter		Off	✓	✓	✓	64	
	 Image Stabilizer			✓	✓	✓	49	
	Bracketing	AE BKT		Off	✓	✓	✓	63
		WB BKT	A-B	Off				63
			G-M					63
		FL BKT		Off				63
		ISO BKT		Off				64
		ART BKT		Off				64
	Multiple Exposure	Frame		Off	✓	✓	62	
		Auto Gain		Off				
		Overlay		Off				
			±0.0	✓	✓	✓	66	
	 RC Mode		Off	✓	✓	✓	97	

Playback Menu

Tab	Function		Default	*1	*2	*3		
		Start	—				71	
		BGM	Melancholy		✓	✓		
		Effect	Fade		✓	✓		
		Slide	All		✓	✓		
		Slide Interval	3 sec		✓			
		Movie Interval	Short		✓			
				On		✓	70	
	Edit	Sel. Image	RAW Data Edit	—	✓	✓	72	
			JPEG Edit	—				72
				—				73
Image Overlay		—	73					
			—			81		
Reset Protect				—			70	

Setup Menu

Tab	Function	Default	*1	*2	*3	👉	
🔧		—				9	
	*	—				85	
		±0, ±0, Natural		✓	✓	85	
	Rec View	0.5 sec	✓	✓	✓	85	
	/🗨️ Menu Display	Menu Display	On		✓		85
		🗨️ Menu Display	Off				
Firmware	—					85	

* Settings differ depending on the region where the camera is purchased.

Custom Menu

Tab	Function	Default	*1	*2	*3	👉	
🔧	AF/MF						
	AF Mode	Still Picture	S-AF	✓	✓	✓	86
		Movie	C-AF				
	Full-time AF	Off	✓	✓	✓		
	AEL/AFL	S-AF	mode1	✓	✓	✓	
		C-AF	mode2				
		MF	mode1				
	Reset Lens	On		✓	✓		
	BULB/TIME Focusing	On		✓	✓		
	Focus Ring	🔄	✓	✓	✓		
	MF Assist	Off	✓	✓	✓		
	Set Home		✓	✓	✓		
	AF Illuminat.	On	✓	✓	✓		
	👤 Face Priority		✓	✓	✓		
	Button/dial						
Button Function	Function	AEL/AFL	✓	✓	✓		
	Function	Multi Function (Highlight&Shadow Control)					
	Function	📽 REC					
	Function	⚡					
	Function	/🌙					
	Function						
	Function	AEL/AFL					
	Function						
Function	AF Stop						
Dial Function	P	Ps,	✓	✓	87		
	A	FNo.,					
	S	Shutter,					
	M	Shutter, FNo.					
	Menu	⬆, ⬇, ⬆					
		Q, Prev/Next					
Dial Direction	Dial1	✓	✓				

Tab	Function	Default	*1	*2	*3			
	Release/							
		RIs Priority S	Off	✓	✓	✓	87	
		RIs Priority C	On	✓	✓	✓		
		L fps	3.5 fps	✓	✓	✓		
		H fps	9 fps	✓	✓	✓		
		+ IS Off	On					
		Half Way RIs With IS	Off		✓			
		Disp/						
		HDMI	HDMI Out	1080i		✓		87
			HDMI Control	Off			✓	
		Video Out*		—				
			iAUTO	Live Guide			✓	
			P/A/S/M	Live Control			✓	
			ART	Art Menu			✓	
			SCN	Scene Menu			✓	
			Info	Image Only, Overall	✓	✓	✓	
			LV-Info	Image Only, , Level Gauge	✓	✓		
			Settings	25, Calendar	✓	✓		
		Displayed Grid		Off	✓	✓		
Picture Mode Settings		On	✓	✓				
Histogram Settings		Highlight	255			✓		
		Shadow	0					
Mode Guide		On			✓			
Live View Boost		Off	✓	✓	✓			
Art LV Mode		mode1			✓			
LV Close Up Mode		mode1			✓			
Info Off		10 sec	✓	✓	✓			
Backlit LCD		8 sec	✓	✓	✓			
Sleep		1 min	✓	✓	✓			
Auto Power Off		4h		✓	✓			
		On	✓	✓	✓			
USB Mode		Auto		✓	✓			
	Exp/							
	EV Step		1/3EV	✓	✓	✓	88	
	Metering			✓	✓	✓		
	AEL Metering		Auto	✓	✓	✓		
	ISO		Auto	✓	✓	✓		
	ISO Step		1/3EV	✓	✓	✓		
	ISO-Auto Set		High Limit: 1600 Default: 200	✓	✓			
	ISO-Auto		P/A/S	✓	✓	✓		
	BULB/TIME Timer		8 min	✓	✓	✓		
	Live BULB		Off	✓	✓			
	Live TIME		0.5 sec	✓	✓			
	Anti-Shock		Off	✓	✓	✓		
							89	

* Settings differ depending on the region where the camera is purchased.

Tab	Function	Default	*1	*2	*3	
	Custom					
	X-Sync.	1/250	✓	✓	✓	89
	Slow Limit	1/60	✓	✓	✓	
	+	Off	✓	✓	✓	
	/Color/WB					
	Noise Reduct.	Auto	✓	✓	✓	89
	Noise Filter	Standard	✓	✓	✓	
	WB	Auto A:0, G:0	✓	✓	✓	
	All	All Set All Reset	— —	✓ ✓	✓ ✓	
	Keep Warm Color	On	✓	✓	✓	90
	+WB	AUTO	✓	✓	✓	
	Color Space	sRGB	✓	✓	✓	
	Shading Comp.	Off	✓	✓	✓	
	Set	—	✓	✓	✓	
	Pixel Count	Middle Small	2560×1920 1280×960	✓	✓	
Record/Erase						
Quick Erase	Off	✓	✓	✓	90	
RAW+JPEG Erase	RAW+JPEG	✓	✓	✓		
File Name	Reset		✓	✓	91	
Edit Filename	Off		✓	✓		
Priority Set	No		✓	✓		
dpi Setting	350dpi		✓	✓		
Copyright Settings	Copyright Info.	Off		✓		
	Artist Name	—		✓		
	Copyright Name	—		✓		
Movie						
Mode	P		✓	✓	92	
Movie+Still	Off	✓	✓	✓		
Movie	On	✓	✓	✓		
Movie Effect	On		✓	✓		
Wind Noise Reduction	Off		✓	✓		
Recording Volume	Standard		✓	✓		
Built-In EVF						
Built-in EVF Style	Style 1	✓	✓	✓	92	
Info Settings	Image Only, , Level Gauge		✓	✓		
Displayed Grid	Off	✓	✓	✓		
EVF Auto Switch	On		✓	✓		
Frame Rate	Normal	✓	✓	✓		
EVF Adjust	±0, ±0		✓	✓		
Utility						
Pixel Mapping	—				92	
Exposure Shift		±0	✓	✓		
Warning Level	±0		✓	✓		

Tab	Function	Default	*1	*2	*3	
⚙️	Battery Priority	PBH Battery	✓	✓		92
	Level Adjust	—		✓		
	Touch Screen Settings	On	✓	✓		93
Eye-Fi	On		✓			

Accessory Port Menu

Tab	Function	Default	*1	*2	*3		
	OLYMPUS PENPAL Share						
	Please Wait	—				76, 95	
	Address Book	Address List	—				95
		Search Timer	30sec		✓		
		New Pairing	—				
	My OLYMPUS PENPAL	—					
	Picture Send Size	Size 1: Small			✓		
	OLYMPUS PENPAL Album						
	Copy All	—				95	
	Reset Protect	—					
	Album Mem. Usage	—					
	Album Mem. Setup	—					
	Picture Copy Size	Size 2: Medium			✓		
	Electronic Viewfinder						
	EVF Adjust	±0, ±0			✓	✓	95

Specifications

Camera

Product type	
Product type	Digital camera with interchangeable lens system
Lens	M.Zuiko Digital, Micro Four Thirds System Lens
Lens mount	Micro Four Thirds mount
Equivalent focal length on a 35mm film camera	Approx. twice the focal length of the lens
Image pickup device	
Product type	4/3" Live MOS sensor
No. of total pixels	Approx. 17,200,000 pixels
No. of effective pixels	Approx. 16,050,000 pixels
Screen size	17.3 mm (H) × 13.0 mm (V)
Aspect ratio	1.33 (4:3)
Viewfinder	
Type	Electronic viewfinder with eye sensor
No. of pixels	1,440,000 pixels
Magnification	100%
Eye point	Approx. 18 mm (−1 m ⁻¹)
Monitor	
Product type	3.0" organic electro-luminescent display, vari-angle, touch screen
Total no. of pixels	Approx. 610,000 dots (aspect ratio 3:2)

Shutter	
Product type	Computerized focal-plane shutter
Shutter	1/4000-60 sec., bulb photography, time photography
Auto focus	
Product type	Imager contrast detection system
Focusing points	35 points
Selection of focusing point	Auto, Optional
Exposure control	
Metering system	TTL metering system (imager metering) Digital ESP metering/Center weighted averaging metering/Spot metering
Metered range	EV 0-20 (Digital ESP metering/Center weighted averaging metering/Spot metering)
Shooting modes	IAUTO : iAUTO/ P : Program AE (Program shift can be performed)/ A : Aperture priority AE/ S : Shutter priority AE/ M : Manual/ ART : Art filter/ SCN : Scene/ MOVIE : Movie
ISO sensitivity	200-25600 (1/3, 1 EV step)
Exposure compensation	±3EV (1/3, 1/2, 1 EV step)
White balance	
Mode setting	Auto/Preset WB (7 settings)/Customized WB/One-touch WB
Recording	
Memory	SD/SDHC/SDXC/Eye-Fi card (supports UHS-I)
Recording system	Digital recording, JPEG (in accordance with Design rule for Camera File system (DCF)), RAW Data, MP format
Applicable standards	Exif 2.2, Digital Print Order Format (DPOF), PRINT Image Matching III, PictBridge
Sound with still pictures	Wave format
Movie	MPEG-4 AVC/H.264 / Motion JPEG
Audio	PCM 48kHz
Playback	
Display format	Single-frame playback/Close-up playback/Index display/Calendar display
Drive	
Drive mode	Single-frame shooting/Sequential shooting/Self-timer
Sequential shooting	Up to 9 fps (☐H)
Self-timer	Operation time: 12 sec., 2 sec.
Flash	
Guide number	10 (ISO200)
Flash control mode	TTL-AUTO (TTL pre-flash mode)/MANUAL
Sync speed	1/250 s or slower
External connector	
Multi-connector (USB connector, AV connector)/HDMI micro connector (Type D)/Accessory port	
Power supply	
Battery	Li-ion Battery ×1
Dimensions/weight	
Dimensions	121.0 mm (W) × 89.6 mm (H) × 41.9 mm (D) (4.8" × 3.5" × 1.7") (excluding protrusions)
Weight	Approx. 425 g (0.9 lb.) (including battery and memory card)
Operating environment	
Temperature	0 °C-40 °C (32 °F-104 °F) (operation)/-20 °C-60 °C (-4 °F-140 °F) (storage)
Humidity	30%-90% (operation)/10%-90% (storage)
Splash resistance	
Type	Equivalent to IEC Standard publication 529 IPX1 (under OLYMPUS test conditions)

Flash

■ FL-LM2

Guide number	10 (ISO200)
Firing angle	Covers the angle of view of a 14 mm lens (28 mm in 35 mm format)
Dimensions	Approx. 44.3 mm (W) × 33.5 mm (H) × 52.5 mm (D) (1.7" × 1.3" × 2.1")
Weight	Approx. 31 g (0.7 lb.)

Battery/charger

■ Lithium ion battery

MODEL NO.	BLN-1
Product type	Rechargeable Lithium ion battery
Nominal voltage	DC7.6V
Nominal capacity	1220 mAh
No. of charge and discharge times	Approx. 500 times (varies with usage conditions)
Ambient temperature	0 °C - 40 °C (32 °F - 104 °F) (charging)
Dimensions	Approx. 36.0 mm (W) × 15.4 mm (H) × 50.2 mm (D) (1.4" × 0.6" × 2.0")
Weight	Approx. 52 g (0.1 lb.)

■ Lithium ion charger

MODEL NO.	BCN-1
Rated input	AC 100V - 240V (50/60Hz)
Rated output	DC8.7V/600mA
Charging time	Approx. 4 hours (room temperature)
Ambient temperature	0 °C - 40 °C (32 °F - 104 °F) (operation)/ -20 °C - 60 °C (-4 °F - 140 °F) (storage)
Dimensions	Approx. 67 mm (W) × 26 mm (H) × 95.5 mm (D) (2.6" × 1.0" × 3.8")
Weight (excluding AC cable)	Approx. 77 g (0.2 lb.)

- The supplied AC adapter is for use with this camera only. Do not use with other devices. Do not use this device with AC cables for other products.

SPECIFICATIONS ARE SUBJECT TO CHANGE WITHOUT ANY NOTICE OR OBLIGATION ON THE PART OF THE MANUFACTURER.

HDMI, the HDMI logo and High-Definition Multimedia Interface are trademarks or registered trademarks of HDMI Licensing LLC.

HDMITM
HIGH-DEFINITION MULTIMEDIA INTERFACE

SAFETY PRECAUTIONS

**CAUTION**RISK OF ELECTRIC SHOCK
DO NOT OPEN

CAUTION: TO REDUCE THE RISK OF ELECTRICAL SHOCK, DO NOT REMOVE COVER (OR BACK). NO USER-SERVICEABLE PARTS INSIDE. REFER SERVICING TO QUALIFIED OLYMPUS SERVICE PERSONNEL.



An exclamation mark enclosed in a triangle alerts you to important operating and maintenance instructions in the documentation provided with the product.

**DANGER**

If the product is used without observing the information given under this symbol, serious injury or death may result.

**WARNING**

If the product is used without observing the information given under this symbol, injury or death may result.

**CAUTION**

If the product is used without observing the information given under this symbol, minor personal injury, damage to the equipment, or loss of valuable data may result.

WARNING!

TO AVOID THE RISK OF FIRE OR ELECTRICAL SHOCK, NEVER DISASSEMBLE, EXPOSE THIS PRODUCT TO WATER OR OPERATE IN A HIGH HUMIDITY ENVIRONMENT.

General Precautions**Read All Instructions** — Before you use the product, read all operating instructions. Save all manuals and documentation for future reference.**Cleaning** — Always unplug this product from the wall outlet before cleaning. Use only a damp cloth for cleaning. Never use any type of liquid or aerosol cleaner, or any type of organic solvent to clean this product.**Attachments** — For your safety, and to avoid damaging the product, use only accessories recommended by Olympus.**Water and Moisture** — For precautions on products with weatherproof designs, read the weatherproofing sections.**Location** — To avoid damage to the product, mount the product securely on a stable tripod, stand, or bracket.**Power Source** — Connect this product only to the power source described on the product label.**Foreign Objects** — To avoid personal injury, never insert a metal object into the product.**Heat** — Never use or store this product near any heat source such as a radiator, heat register,

stove, or any type of equipment or appliance that generates heat, including stereo amplifiers.

Product Handling Precautions **WARNING**

- Do not use the camera near flammable or explosive gases.
- Do not use the flash and LED on people (infants, small children, etc.) at close range.

You must be at least 1 m (3 ft.) away from the faces of your subjects. Firing the flash too close to the subject's eyes could cause a momentary loss of vision.

- Keep young children and infants away from the camera.

Always use and store the camera out of the reach of young children and infants to prevent the following dangerous situations which could cause serious injury:

- Becoming entangled in the camera strap, causing strangulation.
- Accidentally swallowing the battery, cards or other small parts.

- Accidentally firing the flash into their own eyes or those of another child.
- Accidentally being injured by the moving parts of the camera.
- **Do not look at the sun or strong lights with the camera.**
- **Do not use or store the camera in dusty or humid places.**
- **Do not cover the flash with a hand while firing.**

CAUTION

- **Stop using the camera immediately if you notice any unusual odors, noise, or smoke around it.**
Never remove the batteries with bare hands, which may cause a fire or burn your hands.
- **Never hold or operate the camera with wet hands.**
- **Do not leave the camera in places where it may be subject to extremely high temperatures.**
Doing so may cause parts to deteriorate and, in some circumstances, cause the camera to catch fire.
Do not use the charger if it is covered (such as a blanket). This could cause overheating, resulting in fire.
- **Handle the camera with care to avoid getting a low-temperature burn.**
When the camera contains metal parts, overheating can result in a low-temperature burn. Pay attention to the following:
 - When used for a long period, the camera will get hot. If you hold on to the camera in this state, a low temperature burn may be caused.
 - In places subject to extremely cold temperatures, the temperature of the camera's body may be lower than the environmental temperature. If possible, wear gloves when handling the camera in cold temperatures.
- **Be careful with the strap.**
Be careful with the strap when you carry the camera. It could easily catch on stray objects - and cause serious damage.

Battery Handling Precautions

Follow these important guidelines to prevent batteries from leaking, overheating, burning, exploding, or causing electrical shocks or burns.

DANGER

- The camera uses a lithium ion battery specified by Olympus. Charge the battery with the specified charger. Do not use any other chargers.

- Never heat or incinerate batteries.
- Take precautions when carrying or storing batteries to prevent them from coming into contact with any metal objects such as jewelry, pins, fasteners, etc.
- Never store batteries where they will be exposed to direct sunlight, or subjected to high temperatures in a hot vehicle, near a heat source, etc.
- To prevent causing battery leaks or damaging their terminals, carefully follow all instructions regarding the use of batteries. Never attempt to disassemble a battery or modify it in any way, by soldering, etc.
- If battery fluid gets into your eyes, flush your eyes immediately with clear, cold running water and seek medical attention immediately.
- Always store batteries out of the reach of small children. If a child accidentally swallows a battery, seek medical attention immediately.
- Should you notice that the charger is emitting smoke, heat, or an unusual noise or smell, immediately cease use and unplug the charger from the power outlet, and then contact an authorized distributor or service center.

WARNING

- Keep batteries dry at all times.
- To prevent batteries from leaking, overheating, or causing a fire or explosion, use only batteries recommended for use with this product.
- Insert the battery carefully as described in the operating instructions.
- If rechargeable batteries have not been recharged within the specified time, stop charging them and do not use them.
- Do not use a battery if it is cracked or broken.
- If a battery leaks, becomes discolored or deformed, or becomes abnormal in any other way during operation, stop using the camera.
- If a battery leaks fluid onto your clothing or skin, remove the clothing and flush the affected area with clean, running cold water immediately. If the fluid burns your skin, seek medical attention immediately.
- Never subject batteries to strong shocks or continuous vibration.

CAUTION

- Before loading, always inspect the battery carefully for leaks, discoloration, warping, or any other abnormality.
- The battery may become hot during prolonged use. To avoid minor burns, do not remove it immediately after using the camera.
- Always unload the battery from the camera before storing the camera for a long period.

- This camera uses a lithium ion battery specified by Olympus. Do not use any other type of battery. For safe and proper use, read the battery's instruction manual carefully before using it.
- If the battery's terminals get wet or greasy, camera contact failure may result. Wipe the battery well with a dry cloth before use.
- Always charge a battery when using it for the first time, or if it has not been used for a long period.
- When operating the camera with battery power at low temperatures, try to keep the camera and spare battery as warm as possible. A battery that has run down at low temperatures may be restored after it is warmed at room temperature.
- The number of pictures you can take may vary depending on the shooting conditions or battery.
- Before going on a long trip, and especially before traveling abroad, purchase extra batteries. A recommended battery may be difficult to obtain while traveling.
- When the camera will not be used for an extended period, store it in a cool place.
- Please recycle batteries to help save our planet's resources. When you throw away dead batteries, be sure to cover their terminals and always observe local laws and regulations.

Caution for Usage Environment

- To protect the high-precision technology contained in this product, never leave the camera in the places listed below, no matter if in use or storage:
 - Places where temperatures and/or humidity are high or go through extreme changes. Direct sunlight, beaches, locked cars, or near other heat sources (stove, radiator, etc.) or humidifiers.
 - In sandy or dusty environments.
 - Near flammable items or explosives.
 - In wet places, such as bathrooms or in the rain. When using products with weatherproof designs, read their manuals as well.
 - In places prone to strong vibrations.
- Never drop the camera or subject it to severe shocks or vibrations.
- When mounted on a tripod, adjust the position of the camera with the tripod head. Do not twist the camera.
- Do not leave the camera pointed directly at the sun. This may cause lens or shutter curtain damage, color failure, ghosting on the image pickup device, or may possibly cause fires.

- Do not allow direct sunlight into the viewfinder. Failure to observe this precaution may result in image burn-in.
- Do not touch electric contacts on cameras and interchangeable lenses. Remember to attach the body cap when removing the lens.
- Before storing the camera for a long period, remove the battery. Select a cool, dry location for storage to prevent condensation or mold from forming inside the camera. After storage, test the camera by turning it on and pressing the shutter release button to make sure that it is operating normally.
- The camera may malfunction if it is used in a location where it is subject to a magnetic/ electromagnetic field, radio waves, or high voltage, such as near a TV set, microwave, video game, loud speakers, large monitor unit, TV/radio tower, or transmission towers. In such cases, turn the camera off and on again before further operation.
- Always observe the operating environment restrictions described in the camera's manual.
- Do not directly touch or wipe the image pickup device of the camera.

Monitor

An organic electro-luminescent display is used on the rear of the camera.

- Prolonged display of a single image may burn the image into the display, resulting in decreased brightness or mottling in some areas of the monitor. In some cases this effect may be permanent. Image data are not affected.
- In the unlikely event of the monitor breaking, do not put the organic substance into your mouth. Any of the material adhering to your hands, feet, or clothing should be rinsed off immediately.
- A strip of light may appear on the top/bottom of the monitor, but this is not a malfunction.
- When a subject is viewed diagonally in the camera, the edges may appear zigzagged on the monitor. This is not a malfunction; it will be less noticeable in playback mode.
- In places subject to low temperatures, the monitor may take a long time to turn on or its color may change temporarily. When using the camera in extremely cold places, it is a good idea to occasionally place it in a warm place. A monitor exhibiting poor performance due to low temperatures will recover in normal temperatures.
- The monitor is made with high-precision technology. However, black spots or bright spots of light may appear constantly on the monitor.

Due to its characteristics or the angle at which you are viewing the monitor, the spot may not be uniform in color and brightness. This is not a malfunction.

Lens

- Do not immerse in water or splash with water.
- Do not drop or exert strong force on the lens.
- Do not hold at the moving part of the lens.
- Do not touch the lens surface directly.
- Do not touch the contact points directly.
- Do not subject to abrupt temperature changes.
- The operating temperature range is -10°C - 40°C (14°F - 104°F). Always use within this temperature range.

Legal and Other Notices

- Olympus makes no representations or warranties regarding any damages, or benefit expected by using this unit lawfully, or any request from a third person, which are caused by the inappropriate use of this product.
- Olympus makes no representations or warranties regarding any damages or any benefit expected by using this unit lawfully which are caused by erasing picture data.

Disclaimer of Warranty

- Olympus makes no representations or warranties, either expressed or implied, by or concerning any content of these written materials or software, and in no event shall be liable for any implied warranty of merchantability or fitness for any particular purpose or for any consequential, incidental or indirect damages (including but not limited to damages for loss of business profits, business interruption and loss of business information) arising from the use or inability to use these written materials or software or equipment. Some countries do not allow the exclusion or limitation of liability for consequential or incidental damages, so the above limitations may not apply to you.
- Olympus reserves all rights to this manual.

Warning

Unauthorized photographing or use of copyrighted material may violate applicable copyright laws. Olympus assumes no responsibility for unauthorized photographing, use or other acts that infringe upon the rights of copyright owners.

Copyright Notice

All rights reserved. No part of these written materials or this software may be reproduced or used in any form or by any means, electronic or mechanical, including photocopying and recording or the use of any type of information storage and retrieval system, without the prior written permission of Olympus. No liability is assumed with respect to the use of the information contained in these written materials or software, or for damages resulting from the use of the information contained therein. Olympus reserves the right to alter the features and contents of this publication or software without obligation or advance notice.

FCC Notice

- Radio and Television Interference
Changes or modifications not expressly approved by the manufacturer may void the user's authority to operate this equipment. This equipment has been tested and found to comply with the limits for a Class B digital device, pursuant to Part 15 of the FCC Rules. These limits are designed to provide reasonable protection against harmful interference in a residential installation. This equipment generates, uses, and can radiate radio frequency energy and, if not installed and used in accordance with the instructions, may cause harmful interference to radio communications. However, there is no guarantee that interference will not occur in a particular installation. If this equipment does cause harmful interference to radio or television reception, which can be determined by turning the equipment off and on, the user is encouraged to try to correct the interference by one or more of the following measures:
 - Adjust or relocate the receiving antenna.
 - Increase the distance between the camera and receiver.
 - Connect the equipment to an outlet on a circuit different from that to which the receiver is connected.
 - Consult your dealer or an experienced radio/TV technician for help. Only the OLYMPUS-supplied USB cable should be used to connect the camera to USB enabled personal computers (PC).

Any unauthorized changes or modifications to this equipment would void the user's authority to operate it.

Use Only Dedicated Rechargeable Battery and Battery Charger

We strongly recommend that you use only the genuine Olympus dedicated rechargeable battery and battery charger with this camera.

Using a non-genuine rechargeable battery and/or battery charger may result in fire or personal injury due to leakage, heating, ignition or damage to the battery. Olympus does not assume any liability for accidents or damage that may result from the use of a battery and/or battery charger that are not genuine Olympus accessories.

For customers in North and South America

For customers in USA

Declaration of Conformity

Model Number : E-M5

Trade Name : OLYMPUS

Responsible Party : **OLYMPUS IMAGING AMERICA INC.**

Address : 3500 Corporate Parkway, P. O. Box 610, Center Valley, PA 18034-0610, USA

Telephone Number : 484-896-5000

Tested To Comply With FCC Standards

FOR HOME OR OFFICE USE

This device complies with Part 15 of the FCC rules. Operation is subject to the following two conditions:

- (1) This device may not cause harmful interference.
- (2) This device must accept any interference received, including interference that may cause undesired operation.

For customers in Canada

This Class B digital apparatus complies with Canadian ICES-003.

OLYMPUS WORLDWIDE LIMITED WARRANTY - IMAGING PRODUCTS

Olympus warrants that the enclosed Olympus® imaging product(s) and related Olympus® accessories (individually a "Product" and collectively the "Products") will be free from defects in materials and workmanship under normal use and service for a period of one (1) year from the date of purchase.

If any Product proves to be defective within the one-year warranty period, the customer must return the defective Product to any of Olympus Service Centers, following the procedure set forth below (See "WHAT TO DO WHEN SERVICE IS NEEDED").

Olympus, at its sole discretion, will repair, replace, or adjust the defective Product, provided that Olympus investigation and factory inspection disclose that (a) such defect developed under normal and proper use and (b) the Product is covered under this limited warranty.

Repair, replacement, or adjustment of defective Products shall be Olympus's sole obligation and the customer's sole remedy hereunder.

The customer is liable and shall pay for shipment of the Products to the Olympus Service Center.

Olympus shall not be obligated to perform preventive maintenance, installation, deinstallation, or maintenance.

Olympus reserves the right to (i) use reconditioned, refurbished, and/or serviceable used parts (that meet Olympus's quality assurance standards) for warranty or any other repairs and (ii) make any internal or external design and/or feature changes on or to its products without any liability to incorporate such changes on or to the Products.

WHAT IS NOT COVERED BY THIS LIMITED WARRANTY

Excluded from this limited warranty and not warranted by Olympus in any fashion, either express, implied, or by statute, are:

- (a) products and accessories not manufactured by Olympus and/or not bearing the "OLYMPUS" brand label (the warranty coverage for products and accessories of other manufacturers, which may be distributed by Olympus, is the responsibility of the manufacturers of such products and accessories in accordance with the terms and duration of such manufacturers' warranties);
- (b) any Product which has been disassembled, repaired, tampered with, altered, changed, or modified by persons other than Olympus's own authorized service personnel unless repair by others is made with the written consent of Olympus;

- (c) defects or damage to the Products resulting from wear, tear, misuse, abuse, negligence, sand, liquids, impact, improper storage, nonperformance of scheduled operator and maintenance items, battery leakage, use of non-"OLYMPUS" brand accessories, consumables, or supplies, or use of the Products in combination with non-compatible devices;
- (d) software programs;
- (e) supplies and consumables (including but not limited to lamps, ink, paper, film, prints, negatives, cables and batteries); and/or
- (f) Products which do not contain a validly placed and recorded Olympus serial number, unless they are a model on which Olympus does not place and record serial numbers.

EXCEPT FOR THE LIMITED WARRANTY SET FORTH ABOVE, OLYMPUS MAKES NO AND DISCLAIMS ALL OTHER REPRESENTATIONS, GUARANTIES, CONDITIONS, AND WARRANTIES CONCERNING THE PRODUCTS, WHETHER DIRECT OR INDIRECT, EXPRESS OR IMPLIED, OR ARISING UNDER ANY STATUTE, ORDINANCE, COMMERCIAL USAGE OR OTHERWISE, INCLUDING BUT NOT LIMITED TO ANY WARRANTY OR REPRESENTATION AS TO THE SUITABILITY, DURABILITY, DESIGN, OPERATION, OR CONDITION OF THE PRODUCTS (OR ANY PART THEREOF) OR THE MERCHANTABILITY OF THE PRODUCTS OR THEIR FITNESS FOR A PARTICULAR PURPOSE, OR RELATING TO THE INFRINGEMENT OF ANY PATENT, COPYRIGHT, OR OTHER PROPRIETARY RIGHT USED OR INCLUDED THEREIN. IF ANY IMPLIED WARRANTIES APPLY AS A MATTER OF LAW, THEY ARE LIMITED IN DURATION TO THE LENGTH OF THIS LIMITED WARRANTY.

SOME STATES MAY NOT RECOGNIZE A DISCLAIMER OR LIMITATION OF WARRANTIES AND/OR LIMITATION OF LIABILITY SO THE ABOVE DISCLAIMERS AND EXCLUSIONS MAY NOT APPLY.

THE CUSTOMER MAY ALSO HAVE DIFFERENT AND/OR ADDITIONAL RIGHTS AND REMEDIES THAT VARY FROM STATE TO STATE.

THE CUSTOMER ACKNOWLEDGES AND AGREES THAT OLYMPUS SHALL NOT BE RESPONSIBLE FOR ANY DAMAGES THAT THE CUSTOMER MAY INCUR FROM DELAYED SHIPMENT, PRODUCT FAILURE, PRODUCT DESIGN, SELECTION, OR PRODUCTION, IMAGE OR DATA LOSS OR IMPAIRMENT OR FROM ANY OTHER CAUSE, WHETHER LIABILITY IS ASSERTED IN CONTRACT, TORT (INCLUDING NEGLIGENCE AND STRICT

PRODUCT LIABILITY) OR OTHERWISE. IN NO EVENT SHALL OLYMPUS BE LIABLE FOR ANY INDIRECT, INCIDENTAL, CONSEQUENTIAL OR SPECIAL DAMAGES OF ANY KIND (INCLUDING WITHOUT LIMITATION LOSS OF PROFITS OR LOSS OF USE), WHETHER OR NOT OLYMPUS SHALL BE OR SHOULD BE AWARE OF THE POSSIBILITY OF SUCH POTENTIAL LOSS OR DAMAGE.

Representations and warranties made by any person, including but not limited to dealers, representatives, salespersons, or agents of Olympus, which are inconsistent or in conflict with or in addition to the terms of this limited warranty, shall not be binding upon Olympus unless reduced to writing and approved by an expressly authorized officer of Olympus. This limited warranty is the complete and exclusive statement of warranty which Olympus agrees to provide with respect to the Products and it shall supersede all prior and contemporaneous oral or written agreements, understandings, proposals, and communications pertaining to the subject matter hereof. This limited warranty is exclusively for the benefit of the original customer and cannot be transferred or assigned.

WHAT TO DO WHEN SERVICE IS NEEDED

The customer must transfer any image or other data saved on a Product to another image or data storage medium and/or remove any film from the Product prior to sending the Product to Olympus for service.

IN NO EVENT SHALL OLYMPUS BE RESPONSIBLE FOR SAVING, KEEPING OR MAINTAINING ANY IMAGE OR DATA SAVED ON A PRODUCT RECEIVED BY IT FOR SERVICE, OR ON ANY FILM CONTAINED WITHIN A PRODUCT RECEIVED BY IT FOR SERVICE, NOR SHALL OLYMPUS BE RESPONSIBLE FOR ANY DAMAGES IN THE EVENT ANY IMAGE OR DATA IS LOST OR IMPAIRED WHILE SERVICE IS BEING PERFORMED (INCLUDING, WITHOUT LIMITATION, DIRECT, INDIRECT, INCIDENTAL, CONSEQUENTIAL OR SPECIAL DAMAGES, LOSS OF PROFITS OR LOSS OF USE), WHETHER OR NOT OLYMPUS SHALL BE OR SHOULD BE AWARE OF THE POSSIBILITY OF SUCH POTENTIAL LOSS OR IMPAIRMENT.

Package the Product carefully using ample padding material to prevent damage in transit and either deliver it to the Authorized Olympus Dealer that sold you the Product or ship it postage prepaid and insured to any of our Olympus Service Centers.

When returning Products for service, your package should include the following:

- 1 Sales receipt showing date and place of purchase.
- 2 Copy of this limited warranty **bearing the Product serial number corresponding to the serial number on the Product** (unless it is a model on which Olympus does not place and record serial numbers).
- 3 A detailed description of the problem.
- 4 Sample prints, negatives, digital prints (or files on disk) if available and related to the problem.

When service is completed, the Product will be returned to you postage prepaid.

WHERE TO SEND PRODUCT FOR SERVICE

See "WORLDWIDE WARRANTY" for the nearest service center.

INTERNATIONAL WARRANTY SERVICE

International warranty service is available under this warranty.

For customers in Europe



"CE" mark indicates that this product complies with the European requirements for safety, health, environment and customer protection. "CE" mark cameras are intended for sales in Europe.



This symbol [crossed-out wheeled bin WEEE Annex IV] indicates separate collection of waste electrical and electronic equipment in the EU countries.

Please do not throw the equipment into the domestic refuse.

Please use the return and collection systems available in your country for the disposal of this product.



This symbol [crossed-out wheeled bin Directive 2006/66/EC Annex II] indicates separate collection of waste batteries in the EU countries.

Please do not throw the batteries into the domestic refuse.

Please use the return and collection systems available in your country for the disposal of the waste batteries.

Provisions of warranty

- 1 If this product proves to be defective, although it has been used properly (in accordance with the written Handling Care and Operating instructions supplied with it), during the applicable national warranty period and has been purchased from an authorized Olympus distributor within the business area of Olympus Europa Holding GmbH as stipulated on the website: <http://www.olympus.com> this product will be repaired, or at Olympus's option replaced, free of charge. To claim under this warranty the customer must take the product before the end of the applicable national warranty period to the dealer where the product was purchased or any other Olympus service station within the business area of Olympus Europa Holding GmbH as stipulated on the website: <http://www.olympus.com>. During the one year period of the World Wide Guarantee the customer may turn the product in at any Olympus service station. Please notice that not in all countries such Olympus service station exists.
- 2 The customer shall transport the product to the dealer or Olympus authorized service station at his own risk and shall be responsible for any costs incurred in transporting the product.

Provisions of Guarantee

- 1 "OLYMPUS IMAGING CORP., Shinjuku Monolith, 2-3-1 Nishi-Shinjuku, Shinjuku-ku, Tokyo 163-0914, Japan grants a one year World Wide Guarantee. This worldwide Guarantee must be presented at an Olympus authorized repair service station before any repair can be made under conditions of this Guarantee. This Guarantee is valid only if the Guarantee Certificate and proof of purchase are presented at the Olympus repair service station. Please note that this Guarantee is in addition to and does not affect the customer's legal warranty rights under the applicable national legislation governing the sale of consumer goods mentioned above.
- 2 This Guarantee does not cover the following and the customer will be required to pay repair charge, even for defects occurring within the Guarantee period referred to above.
 - (a) Any defect that occurs due to mishandling (such as an operation performed that is not mentioned in the Handling Care or other sections of the instructions, etc.)
 - (b) Any defect that occurs due to repair, modification, cleaning, etc. performed by anyone other than Olympus or an Olympus authorized service station.

- (c) Any defect or damage that occurs due to transport, a fall, shock, etc. after purchase of the product.
 - (d) Any defect or damage that occurs due to fire, earthquake, flood damage, thunderbolt, other natural disasters, environmental pollution and irregular voltage sources.
 - (e) Any defect that occurs due to careless or improper storage (such as keeping the product under conditions of high temperature and humidity, near insect repellents such as naphthalene or harmful drugs, etc.), improper maintenance, etc.
 - (f) Any defect that occurs due to exhausted batteries, etc.
 - (g) Any defect that occurs due to sand, mud, etc. entering the inside of the product casing.
 - (h) When the Guarantee Certificate is not returned with the product.
 - (i) When any alterations whatsoever are made to the Guarantee Certificate regarding the year, month and date of purchase, the customer's name, the dealer's name, and the serial number.
 - (j) When proof of purchase is not presented with this Guarantee Certificate.
- 3 This Guarantee applies to the product only; the Guarantee does not apply to any other accessory equipment, such as the case, strap, lens cap and batteries.
- 4 Olympus's sole liability under this Guarantee shall be limited to repairing or replacing the product. Any liability under the Guarantee for indirect or consequential loss or damage of any kind incurred or suffered by the customer due to a defect of the product, and in particular any loss or damage caused to any lenses, films, other equipment or accessories used with the product or for any loss resulting from a delay in repair or loss of data, is excluded. Compelling regulations by law remain unaffected by this.

Notes regarding Guarantee maintenance

- 1 This Guarantee will only be valid if the Guarantee Certificate is duly completed by Olympus or an authorized dealer or other documents contain sufficient proof. Therefore, please make sure that your name, the name of the dealer, the serial number and the year, month and date of purchase are all completed or the original invoice or the sales receipt (indicating the dealer's name, the date of purchase and product type) is attached to this Guarantee Certificate.

Olympus reserves the right to refuse free-of-charge service if neither Guarantee Certificate is completed nor the above document is attached or if the information contained in it is incomplete or illegible.

- 2 Since this Guarantee Certificate will not be re-issued, keep it in a safe place.
- Please refer to the list on the web site: <http://www.olympus.com> for the authorized international Olympus service network.

Trademarks

- IBM is a registered trademark of International Business Machines Corporation.
- Microsoft and Windows are registered trademarks of Microsoft Corporation.
- Macintosh is a trademark of Apple Inc.
- The SDHC and SDXC logos are trademarks.
- Eye-Fi is a trademark of Eye-Fi, Inc.
- "Shadow Adjustment Technology" function contains patented technologies from Apical Limited. 
- Slideshow transition technology supplied by HI Corporation. 
- All other company and product names are registered trademarks and/or trademarks of their respective owners.
- Micro Four Thirds and the Micro Four Thirds logo are trademarks or registered trademarks of OLYMPUS IMAGING Corporation in Japan, the United States, the countries of the European Union, and other countries.
- "PENPAL" is used in reference to the OLYMPUS PENPAL.
- The standards for camera file systems referred to in this manual are the "Design Rule for Camera File System/DCF" standards stipulated by the Japan Electronics and Information Technology Industries Association (JEITA).

THIS PRODUCT IS LICENSED UNDER THE AVC PATENT PORTFOLIO LICENSE FOR THE PERSONAL AND NONCOMMERCIAL USE OF A CONSUMER TO (i) ENCODE VIDEO IN COMPLIANCE WITH THE AVC STANDARD ("AVC VIDEO") AND/OR (ii) DECODE AVC VIDEO THAT WAS ENCODED BY A CONSUMER ENGAGED IN A PERSONAL AND NON-COMMERCIAL ACTIVITY AND/OR WAS OBTAINED FROM A VIDEO PROVIDER LICENSED TO PROVIDE AVC VIDEO. NO LICENSE IS GRANTED OR SHALL BE IMPLIED FOR ANY OTHER USE. ADDITIONAL INFORMATION MAY BE OBTAINED FROM MPEG LA, L.L.C. SEE [HTTP://WWW.MPEGLA.COM](http://www.mpegla.com)

System chart

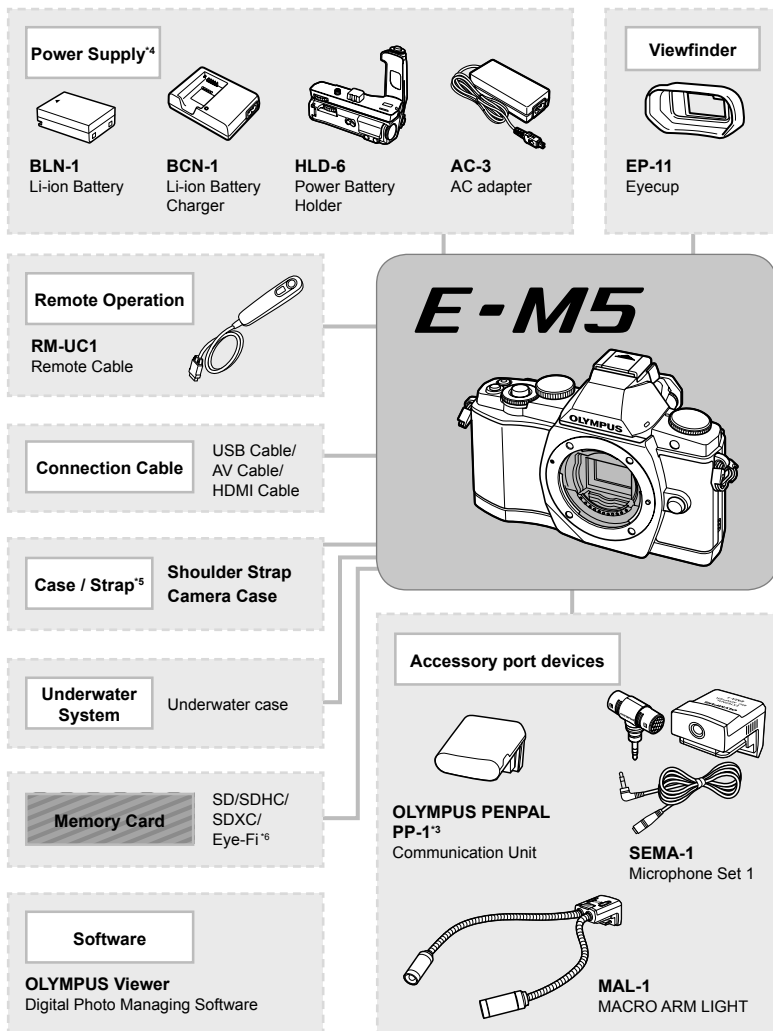

*1 Not all lenses can be used with adapter. For details, refer to the Olympus Official Web Site. Also, please note that manufacture of OM System Lenses has been discontinued.

*2 For compatible lens, refer to the Olympus Official Web Site.

*3 The OLYMPUS PENPAL can be used only in the region in which it was purchased. Depending on the areas, the usage may infringe the wave regulations and may be subject to its penalty.

 : E-M5 compatible products

 : Commercially available products

For the latest information, please visit the Olympus website.

Lens



M.ZUIKO DIGITAL 12-50mm f3.5-6.3 EZ
M.ZUIKO DIGITAL ED 12mm f2.0
M.ZUIKO DIGITAL 17mm f2.8
M.ZUIKO DIGITAL 45mm f1.8
M.ZUIKO DIGITAL 14-42mm f3.5-5.6 II R
M.ZUIKO DIGITAL ED 9-18mm f4.0-5.6
M.ZUIKO DIGITAL ED 14-150mm f4.0-5.6 R
M.ZUIKO DIGITAL ED 40-150mm f4.0-5.6 R
M.ZUIKO DIGITAL ED 75-300mm f4.8-6.7

Converter Lens²



FCON-P01
Fisheye



WCON-P01
Wide



MCON-P01
Macro

Four Thirds System Lenses



MMF-3*1
Four Thirds Adapter

OM System Lenses



MF-2*1
OM Adapter 2

Flash

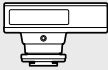

FL-14
Electronic Flash



FL-600R
Electronic Flash



FL-300R
Electronic Flash



SRF-11 Ring Flash Set



RF-11*2
Ring Flash



STF-22 Twin Flash Set



TF-22*2
Twin Flash



FC-1 Macro Flash Controller

*4 Use only compatible battery chargers to charge rechargeable batteries.

*5 Some accessories may not be available in your region.

*6 Use in accordance with local regulations.

Index

Symbols

Shooting Menu 1	111
Shooting Menu 2	111
Playback Menu	111
Setup Menu	85, 112
Custom Menu	86, 112
Accessory port menu	95, 115
AF/MF	86
Button/Dial	86
Release/	87
Disp/	87
Exp/	88
Custom	89
/Color/WB	89
Record/Erase	90
Movie	92
Built-In EVF	92
Utility	92
OLYMPUS PENPAL Share	95
OLYMPUS PENPAL Album	95
Electronic Viewfinder	95
L (Large)	54
M (Middle)	54, 90
S (Small)	54, 90
RC Mode	97
(Language selection)	85
/Menu Display	85, 86
Set Home	86
Face Priority	46, 86
L fps	87
H fps	87
+ IS Off	87
Control Settings	87
/Info Settings	87
(Beep sound)	88
Slow Limit	89
X-Sync	89
+	89
AUTO Keep Warm Color	90

+WB	90
Set	90
Info Settings	92
Displayed Grid	92
Warning Level	92
Battery Priority	92
REC	94
Home	94
(Digital Tele-converter)	94
(AEL lock)	48
ART (Art filter mode)	18
SCN (Scene mode)	19
(Movie mode)	67
(Close-up playback)	16, 69
(Index display)	16, 69
(Protecting)	17

A

Adding sound to still pictures	73
Address Book	77, 95
AE BKT	63
AEL Metering	88
AEL/AFL	86, 93
AF illuminator	86
AF Mode	43, 86
AF target	44
Album Mem. Setup	95
Album Mem. Usage	95
All	89
All Erase	70
All Targets	44
Anti-Shock	89
Aperture priority shooting A	57
Aperture value	14, 57, 58
ART BKT	64
Art LV Mode	88
Aspect	72
Auto flash	65
Auto focus	14, 43, 98
Auto white balance	50

B	
B&W Filter	53
Backlit LCD	88
Battery	3, 4, 104
BGM	71
Black & White	72
Bracketing	63
Bulb photography	59
BULB/TIME Timer	89
Button Function	86

C	
C-AF (continuous AF)	43
C-AF+TR (AF Tracking)	43
Calendar display	69
Card	5, 103
Card Setup	70, 103
Center weighted averaging metering [C]	48
Color Space	90
Compression rate	54
Continuous AF (C-AF)	43
Contrast	53
Copy All	77
Copyright Settings	91
Custom [C]	52
Custom white balance CWB	50

D	
Date/time setting [D]	9
Dial Direction	87
Dial Function	87
Digital ESP metering [ESP]	48
Digital Tele-converter	64
Direct print	82
dpi Setting	91
Dust reduction	102

E	
Easy printing	83
Easy shooting modes	12
Edit Filename	91
Effect	53

e-Portrait	72
EV Step	88
EVF Adjust	92
Exposure compensation [AE-L/AF-ON]	47
Exposure Shift	92
Eye-Fi	93
Eye-Fi card	5, 103

F	
File Name	91
Fill-in flash [Flash]	65
Firmware	85
FL BKT	63
Flash	65
Flash intensity control [Fn]	66
Flash mode [Flash]	65
Flash off [Flash]	65
Focus lock	44
Focus Ring	86
Format	103
Four Thirds system lenses	104
Frame Rate	92
Full-time AF	86

G	
Gradation	53
Group Target	44

H	
Half Way RIs With IS	87
HD	55
Highlight and shadow control	47
High Key	53
Histogram	39, 40
Histogram Settings	88
Home position [HP]	86

I	
iAUTO shooting [iAUTO]	12, 21
i-Enhance [i-Enhance]	52
Image Aspect	55
Image Overlay	73
Image size	54

Image Stabilizer IS	49
INFO button.....	11, 39 – 41
Info Off.....	88
Information display	39, 40
IS (Image stabilizer).....	49
ISO	55, 89
ISO BKT	64
ISO Step	88
ISO-Auto.....	88
ISO-Auto Set	88



J



JPEG	54
JPEG Edit.....	72

L

Lens.....	6, 105
Level Adjust	92
Level Gauge	39
Lithium ion battery	4, 104, 117
Lithium ion charger	4, 104
Live BULB.....	89
Live Control	24
Live Guide	21
Live TIME	89
Live View Boost.....	88
Low Key.....	53
LV Close Up Mode.....	88

M

Manual focus (MF).....	43
Manual shooting M	58
Metering.....	48
MF (manual focus).....	43, 94
MF Assist.....	86
Micro Four Thirds system lenses.....	104
Mode Guide	88
Monitor brightness adjustment 	85
Monotone M	52
Movie Interval	71
Movie Play.....	68
Movie 	68, 92

Movie shooting 	14, 67
Movie+Still	92, 96
MTP.....	80
Multiple Exposure 	62
Muted 	52
My OLYMPUS PENPAL.....	95
Myset	42, 94



N

Natural 	52
Noise Filter	89
Noise Reduct.....	89
NTSC.....	74, 87

O

OLYMPUS PENPAL	76, 95
One-touch white balance 	50, 51





P

PAL	74, 87
Panorama	60
Pict. Tone.....	53
PictBridge	82
Picture Copy Size.....	95
Picture Mode	52
Picture Mode Settings	88
Picture Send Size	95
Pixel Count	90
Pixel Mapping	102
Playback on TV	74
Please Wait	76, 95
Portrait 	52
Preset white balance	50
Preview.....	58
Print.....	81
Print reservation 	81
Priority Set.....	91
Program shift Ps	57
Program shooting P	57







Q





Quick Erase.....	90
------------------	----

R

RAW	54
RAW Data Edit	72
RAW 	94
RAW+JPEG Erase	90
Rec View	85
Record mode 	54, 110
Recording Volume	92
Redeye Fix	72
Red-eye reduction flash 	65
Reset Lens	86
Reset/Myset	42
Reset Protect	70, 95
Resizing 	72
RIs Priority C	87
RIs Priority S	87
Rotate	70

S

S-AF (single AF)	43
S-AF+MF	43
Saturation	53, 72
SD	55
SD/SDHC/SDXC card	5, 103
Self-timer 	56
Sepia	72
Sequential shooting 	56
Shading Comp.	90
Shadow Adj.	72
Sharpness	53
Shutter priority shooting S	58
Shutter speed	14, 57, 58
Single AF (S-AF)	43
Single Target	44
Single-frame erase 	17
Single-frame shooting 	56
Sleep	88
Slide	71
Slideshow 	71
Slow synchronization (1st curtain)  SLOW	65

Slow synchronization (1st curtain)/ Red-eye reduction flash  SLOW	65
Slow synchronization (2nd curtain)  SLOW2/2nd Curtain	65
Spot metering - highlight control  HI	48
Spot metering - shadow control  SH	48
Spot metering 	48
Storage	80
Super control panel	22
Super FP flash	109

T

Test Picture	94
Time photography	59
Touch screen	11, 27
Touch Screen Settings	93
Trimming 	72, 84

U

USB Mode	88
----------------	----

V

Video Out	87
Viewfinder	8, 30
Vivid 	52

W

WB	50, 90
WB BKT	63
White balance compensation 	50
White balance WB	50

Z

Zoom display	45
Zoom frame AF	45

OLYMPUS EUROPA HOLDING GMBH

Premises: Consumer Product Division
Wendenstrasse 14 – 18, 20097 Hamburg, Germany
Tel.: +49 40 - 23 77 3-0 / Fax: +49 40 - 23 07 61

Goods delivery: Bredowstrasse 20, 22113 Hamburg, Germany

Letters: Postfach 10 49 08, 20034 Hamburg, Germany

European Technical Customer Support:

Please visit our homepage <http://www.olympus-europa.com>
or call our TOLL FREE NUMBER*: **00800 - 67 10 83 00**

for Austria, Belgium, Denmark, Finland, France, Germany, Luxemburg, Netherlands,
Norway, Portugal, Spain, Sweden, Switzerland, United Kingdom.

* Please note some (mobile) phone services / provider do not permit access or request an
additional prefix to +800 numbers.

For all not listed European Countries and in case that you can't get connected
to the above mentioned number please make use of the following

CHARGED NUMBERS: **+49 180 5 - 67 10 83** or **+49 40 - 237 73 4899**.

Our Technical Customer Support is available from 9 am to 6 pm MET (Monday to Friday).

Authorized Distributors

United Kingdom: Olympus Service Department

/Eire

Olympus Imaging & Audio
KeyMed House
Stock Road
Southend-on-Sea
Essex
SS2 5QH
United Kingdom

Sales - 0800 111 4777
Service - 0800 111 4888
Facsimile - +44 (0)1702 445134
email - consumer@olympus.co.uk
www.olympus.co.uk

South Africa: Tudor Photographic

4th floor, Park on Long
66 Long Street
Cape Town 8001
South Africa
Tel: +27 (0) 21 423 4150
Fax: +27 (0) 21 424 4632

OLYMPUS®

<http://www.olympus.com/>

OLYMPUS IMAGING CORP.

Shinjuku Monolith, 3-1 Nishi-Shinjuku 2-chome, Shinjuku-ku, Tokyo, Japan

OLYMPUS IMAGING AMERICA INC.

3500 Corporate Parkway, P.O. Box 610, Center Valley, PA 18034-0610, U.S.A. Tel. 484-896-5000

Technical Support (U.S.A.)

24/7 online automated help: <http://www.olympusamerica.com/DSLR>

Phone customer support: Tel. 1-800-260-1625 (Toll-free)

Our phone customer support is available from 9am to 9pm (Monday to Friday) ET

E-Mail: e-slrpro@olympus.com

Olympus software updates can be obtained at: <http://www.olympusamerica.com/digital>

To find the nearest Service Centers, please visit: <http://www.olympusamerica.com/digital>, and click on the Worldwide Warranty icon at the bottom of the page.

Service Centers

U.S.A.:

New York

Olympus Imaging America Inc.

400 Rabro Drive

Hauppauge, NY 11788-4258

Tel: (800) 260-1625

FAX: (631) 881-6510

Canada:

Trinitek Electronics Inc.

3105 Unity Drive, Unit 20

Mississauga Ontario Canada

L5L4L3

Tel: (800) 260-1625

Mexico:

Olympus Imaging de Mexico

S.A. de C.V.

WTC Mexico, Montecito

No.38 - Planta Baja Local 12

Col. Nápoles, Mexico D.F. 03810

Tel: (01800) 900-1280/900-1281