

OLYMPUS

DIGITAL CAMERA OLYMPUS PEN E-P7 Instruction Manual

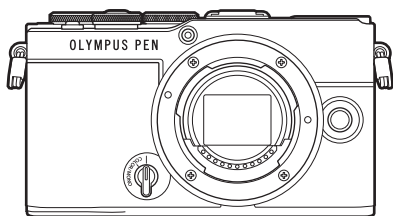

Table of Contents

Quick task index

1. Preparation
2. Shooting
3. Playback
4. Menu functions
5. Connecting the camera to a smartphone
6. Connecting the camera to a computer
7. Cautions
8. Information
9. SAFETY PRECAUTIONS

Model No.: IM024

- Thank you for purchasing our digital camera. Before you start to use your new camera, please read these instructions carefully to enjoy optimum performance and a longer service life.
- Be sure you have read and understood the contents of "9. SAFETY PRECAUTIONS", before using this product. Keep these instructions available for future reference.
- We recommend that you take test shots to get accustomed to your camera before taking important photographs.
- The screen and camera illustrations shown in this manual were produced during the development stages and may differ from the actual product.
- If there are additions and/or modifications of functions due to firmware update for the camera, the contents will differ. For the latest information, please visit our website.

Before You Begin

Read and Follow Safety Precautions

To prevent incorrect operation resulting in fire or other damage to property or harm to yourself or to others, read "9. SAFETY PRECAUTIONS" (P. 191) in its entirety before using the camera.

While using the camera, consult this manual to ensure safe and correct operation. Be sure to keep the manual in a safe place once it is read.

Our company will not be held liable for violations of local regulations arising from use of this product outside the country or region of purchase.

Wireless LAN and Bluetooth®

The camera features built-in wireless LAN and **Bluetooth®**. Use of these features outside the country or region of purchase may violate local wireless regulations; be sure to check with local authorities before use. Our company will not be held liable for the user's failure to comply with local regulations.

Disable wireless LAN and **Bluetooth®** in areas where their use is prohibited.

 "Disabling wireless LAN/Bluetooth®" (P. 163)

■ User Registration

Visit our website for information on registering your products.

■ Installing PC Software/Apps

Olympus Workspace

This computer application is used to download and view photos and movies recorded with the camera. It can also be used to update the camera firmware. The software can be downloaded from the website below. Be prepared to provide the camera serial number when downloading the software.

<https://support.olympus-imaging.com/owdownload/>

OLYMPUS Image Share (OI.Share)

You can load images in the camera to a smartphone.

You can also operate the camera remotely and take pictures from a smartphone.

<https://app.olympus-imaging.com/oishare/>



In addition to the “Instruction Manual”, we also offer a “Camera Function Guide”. Consult these manuals when using the product.

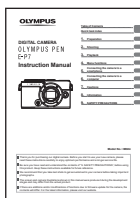

Instruction Manual (this pdf)

A how-to guide to the camera and its features. The Instruction Manual can be downloaded from our website or directly using the “OLYMPUS Image Share” (OI.Share) smartphone app.

Camera Function Guide

A function and setting guide that helps you use camera features to the full. It has been optimized for display on mobile devices and can be viewed using OI.Share.

<https://cs.olympus-imaging.jp/jp/support/cs/webmanual/index.html>



Indications used in this manual

The following symbols are used throughout this manual.













	Symbols designating the buttons (respectively the up, down, left, and right arrow buttons) to press on the arrow pad (P. 13).
	Notes and other supplementary information.
	Tips and other helpful information for using the camera.
	References to other pages in this manual.

Table of Contents

Before You Begin	2	Switching Displays with the  (Shortcut) Button 33
Product Manuals	3	Letting the camera choose aperture and shutter speed (Program mode) 35
Quick task index	9	Choosing aperture (Aperture Priority mode) 37
Names of parts	12	Choosing shutter speed (Shutter Priority mode) 39
Preparation	14	Choosing aperture and shutter speed (Manual mode) 41
Unpacking the box contents 14		Long Exposures (Bulb/Time) 42
Attaching the Strap 15		Lighten Blending (Live Composite Photography) 44
Inserting and Removing the Battery and Card 16		Shooting enhanced images (Profile Control) 46
Removing the battery 17		Shooting enhanced monochrome pictures (Monochrome Profile Control)..... 46
Removing the card 17		Shooting pictures with individual colors adjusted (Color Profile Control)..... 51
Charging the Battery 18		Letting the camera choose the settings (AUTO mode) 54
Attaching a lens to the camera 20		Shooting in scene mode (SCN mode) 56
Removing Lenses 21		Types of scene modes..... 56
Turning the camera on 22		Shooting in advanced photo mode (AP mode) 60
Initial setup 23		AP Mode Options 60
Camera displays unreadable/ not in the selected language 25		[Live Composite]: Live Composite Photography 61
Shooting	26	[Live Time]: Live Time Photography 62
Information displays while shooting 26		[Multiple Exposure]: Shooting Multiple Exposures 63
Switching the information display 28		[HDR]: Taking Composite Photos with HDR 64
Choosing a shooting mode and taking photos 29		[Silent 
Types of shooting modes..... 29		
Taking high angle and low angle shots 31		
Shooting with touch screen operations 32		

Shooting a Panorama.....	66	Shooting without the vibration caused by shutter button operations (Anti-Shock [♦]).....	88
[Keystone Compensation]	67	The Electronic Shutter (Silent [♥])	88
[AE Bracketing]: Varying Exposure over a Series of Shots	68	Calling shooting options	89
[Focus Bracketing]: Varying Focus Distance over a Series of Shots	69	Choosing a focus mode (AF Mode).....	92
Using art filters (ART mode).....	70	Choosing how the camera measures brightness (Metering)	93
Types of art filters	72	Adjusting color (WB (white balance)).....	94
Adjusting the degree of the art filter effect (Fine-Tuning).....	73	Making fine adjustments to white balance (WB Compensation)....	96
Using [Partial Color].....	73	Reducing camera shake (Image Stabilizer)	96
Recording movies in photo shooting modes.....	74	Setting the image aspect.....	97
Recording movies in movie mode	75	Photo File and Image Size Options (Still image quality,  )	98
Movie Mode Options.....	76	Frame Size, Rate, and Compression (Movie quality,  )	99
Recording Slow Motion Movies	77	Adjusting flash output (Flash intensity control)	103
Silencing Camera Sounds While Shooting Movies	77	Processing options (Picture Mode).....	103
Taking Photos in Self-Portrait Mode	78	Adjusting overall color (Color Creator).....	105
Using various settings.....	80	Making fine adjustments to sharpness (Sharpness)	106
Buttons and dials.....	80	Making fine adjustments to contrast (Contrast).....	106
Controlling exposure (Exposure ).....	81	Making fine adjustments to saturation (Saturation).....	106
Selecting the AF target mode (AF Area).....	81	Adding a film grain effect to the Monochrome Profile (Film Grain Effect)	107
Setting the location of the focus (AF target position).....	82	Making fine adjustments to tone (Gradation)	108
Face priority AF/ Eye priority AF	82	Applying filter effects to monochrome pictures (Color Filter).....	108
Changing ISO sensitivity (ISO).....	83		
Using a flash (Flash photography)	84		
Performing the sequential/ self-timer shooting	86		
Self-Timer Options ( Custom Self-timer)	87		

Adjusting the tone of monochrome pictures (Monochrome Color).....	109
Adjusting i-Enhance effects (Effect)	110
Setting the color reproduction format (Color Space).....	110
Changing the brightness of highlights and shadows (Highlight&Shadow Control) ...	111
Assigning functions to buttons (Button Function).....	112
Zoom frame AF/Zoom AF (Super Spot AF).....	113
Choosing an Exposure Mode (Mode (Movie Exposure Modes))	115

Playback 116

Information display during playback	116
Playback image information ...	116
Switching the information display	117
Viewing photographs and movies	118
Finding Pictures Quickly (Index and Calendar Playback)	119
Zooming In (Playback Zoom)	119
Rotating Pictures (Rotate)	119
Viewing Images as a Slideshow (Slide Show)	120
Watching movies	121
Protecting Pictures (Protect)	121
Deleting Pictures (Erase).....	121
Selecting Pictures for Sharing (Share Order)	122
Cancelling all share orders (Reset share Order).....	122

Selecting Multiple Pictures (Protect, Erase Selected, Share Order Selected)	122
Creating a print order (DPOF)	123
Removing all or selected pictures from the print order	124
Adding Audio to Pictures (Audio)	124
Audio Playback (Play)	124
Scrolling Panoramas	125
Using the touch screen	126
Single-frame playback	126
Index/Calendar playback	126
Selecting and protecting images	127
Viewing pictures in self-portrait mode.....	127

Menu functions 128

Basic menu operations	128
Using Shooting Menu 1 / Shooting Menu 2	129
Returning to default settings (Reset).....	129
Processing options (Picture Mode).....	130
Digital Zoom (Digital Tele-converter)	130
Improving Focus in Dark Surroundings (AF Illuminator).....	130
Choosing a Zoom Speed (Elec. Zoom Speed)	131
Recording multiple exposures in a single image (Multiple Exposure).....	131
Shooting automatically with a fixed interval (Intrvl. Sh./Time Lapse)	133
Setting anti-shock/silent shooting (Anti-Shock/Silent)	135

Wireless remote control flash photography (⚡ RC Mode)	135
Using the Video Menu	136
Using the Playback Menu	137
Automatically Rotating Portrait-Orientation Pictures for Playback (📷)	137
Retouching Pictures (Edit)	137
Combining Pictures (Image Overlay)	141
Creating Movie Stills (In-Movie Image Capture)	141
Trimming movies (Movie Trimming)	142
Removing Protection from All Pictures (Reset Protect)	142
Using the setup menu	143
Formatting the card (Card Setup)	144
Deleting all images (Card Setup)	144
Choosing a language (🌐)	144
Using the custom menus	145
A AF/MF	145
B Button/Dial	145
C1 Disp/📷)/PC	146
C2 Disp/📷)/PC	146
D1 Exp/ISO/BULB	147
D2 Exp/ISO/BULB	147
E ⚡ Custom	148
F ⏪/WB/Color	148
G Record	149
H 📷 Utility	150
AEL/AFL	151
Manual Focus Assist (MF Assist)	151
Adding information displays	152
Viewing camera images on TV (HDMI)	153
Shutter speeds when the flash fires (⚡ X-Sync./⚡ Slow Limit)	154
Combinations of JPEG image sizes and compression rates (⏪ Set)	154
Connecting the camera to a smartphone 155	
Pairing the Camera and Smartphone	156
Wireless Connection Standby Setting for When the Camera Is On	157
Wireless Settings for When the Camera Is Off	158
Transferring images to a smartphone	159
Automatically uploading images while the camera is off	160
Automatically setting a share order for photographs	160
Shooting remotely with a smartphone (Live View)	161
Shooting remotely with a smartphone (Remote Shutter)	161
Adding position information to images	162
Resetting wireless LAN/Bluetooth® settings	162
Changing the password	163
Disabling wireless LAN/Bluetooth®	163
Connecting the camera to a computer 164	
Copying pictures to a computer	164
Installing the PC software	165

Cautions	166
■ Batteries	166
■ Using your USB-AC adapter abroad	166
■ Usable cards	167
■ Interchangeable lenses.....	167
■ MF Clutch Lenses.....	168
■ Compatible Flash Units	169
Wireless remote control flash photography.....	170
■ Other external flash units	171
■ System chart.....	172
Information	174
■ Cleaning and storing the camera	174
Cleaning the camera	174
Storage	174
Cleaning and checking the image pickup device.....	174
Pixel Mapping - Checking the image processing functions....	175
■ Shooting tips and information	176
■ Error codes	179
■ Defaults	181
■ Record mode and file size/ number of storable still pictures	186
■ Specifications	188
SAFETY PRECAUTIONS	191
■ SAFETY PRECAUTIONS	191
Index	196

Quick task index

Shooting



Just shoot without making any difficult settings	▶ AUTO mode (AUTO)	54
Shooting in the way you want without needing to know technical terms	▶ Live Guide	54
Taking self-portraits	▶ Self-portraits	78
Taking stylish pictures	▶ Art filter	70
Quickly matching settings to the scene	▶ Scene mode (SCN)	56
Taking pictures with a blurred background	▶ Live Guide	54
	▶ Aperture priority shooting	37
Shooting night views	▶ Portrait + Nightscape (SCN)	56
	▶ Nightscape (SCN)	57
	▶ Hand-Held Starlight (SCN)	57
	▶ Fireworks (SCN)	57
	▶ Live Time (IAP)	62
Photographing fireworks	▶ Live Composite (IAP)	61
	▶ Live Composite (B)	44
	▶ Bulb/time photography (B)	42
	▶ Light Trails (SCN)	57
Photographing light trails	▶ Live Time (IAP)	62
	▶ Live Composite (IAP)	61
	▶ Live Composite (B)	44
	▶ Bulb/time photography (B)	42
Adjusting the brightness of highlights and shadows	▶ Live Guide	54
	▶ Exposure compensation	81
Taking photos with the flash	▶ Flash photography	84
Taking photos without the flash	▶ ISO sensitivity	83
Reducing camera shake	▶ Image Stabilizer	96
	▶ Self-timer	86
Taking pictures of a subject against backlight	▶ Flash photography	84
	▶ Backlight HDR (SCN)	58
	▶ Gradation (Picture Mode)	108
	▶ Spot metering	93
Using the self-timer	▶ Self-timer	86
Sequential shooting	▶ Sequential shooting	86
Changing an aspect ratio	▶ Aspect ratio	97

Changing photo coloring	▶ Live Guide	54
	▶ Picture Mode	103
	▶ White balance	94
Processing pictures to match the subject/Taking monotone pictures	▶ Picture Mode	103
	▶ Art filter (ART)	70
	▶ Profile control	46, 51
Enhancing images	▶ Profile control	46, 51
Taking pictures that stop the subject in motion or convey a sense of motion	▶ Live Guide	54
	▶ Scene mode (SCN)	56
	▶ Shutter priority shooting	39
When the camera will not focus on your subject/Focusing on one area	▶ Tap AF (Using the touch screen)	32
	▶ AF target position	82
	▶ Zoom frame AF/zoom AF	113
Focusing on a small spot in the frame/confirming focus before shooting	▶ Zoom frame AF/zoom AF	113
Keeping a moving subject in focus	▶ C-AF+TR (AF tracking)	92
Focusing on and shooting a moving subject	▶ C-AF	92
Reducing image noise (mottling)	▶ Noise Reduct.	147
Optimizing the monitor/adjusting monitor hue	▶ Live View Boost	146
	▶ Monitor brightness adjustment	143
Checking horizontal or vertical orientation before shooting	▶ Level gauge	28
Shooting with deliberate composition	▶ Displayed Grid	146
Conserving battery power	▶ Sleep	150
Increasing the number of pictures that can be taken	▶ Still image quality mode	98
Using a remote control	▶ Shooting remotely with a smartphone	161
Shooting without the shutter sound	▶ Silent [▼] (SCN)	58
	▶ Silent [▼] (∫AP)	65
	▶ Silent [▼] (P/A/S/M/ART)	88
Zooming in so your subject fills more of the frame	▶ Digital Tele-converter	130
Improving complexions	▶ Portrait (Picture Mode)	104
	▶ e-Portrait (Picture Mode)	104
	▶ Scene mode (SCN)	56

Playback/Retouch



Viewing images on a TV	▶ HDMI	153
	▶ Playback on TV	153
Viewing slideshows with background music	▶ Slideshow	120
Brightening shadows	▶ Shadow Adj (JPEG Edit)	139
Dealing with red-eye	▶ Redeye Fix (JPEG Edit)	139
Printing made easy	▶ Creating a print order	123
Viewing pictures on a smartphone	▶ Transferring images to a smartphone	159
Uploading pictures to a smartphone automatically	▶ Automatically uploading images while the camera is off	160
	▶ Automatically setting a share order for photographs (Auto Share Order)	160
Adding location data to images	▶ Adding location data to images	162
Retouching Pictures	▶ RAW Data Edit (Custom)	137
	▶ RAW Data Edit (ART BKT)	137

Camera Settings



Synchronizing the date and time	▶ Setting the date/time	23
Restoring default settings	▶ Reset	129
Changing the menu display language	▶ (Beep sound)	144
Turning off the auto focus sound	▶ Silent [♥] (SCN)	58
	▶ Silent [♥] (AP)	65

Names of parts

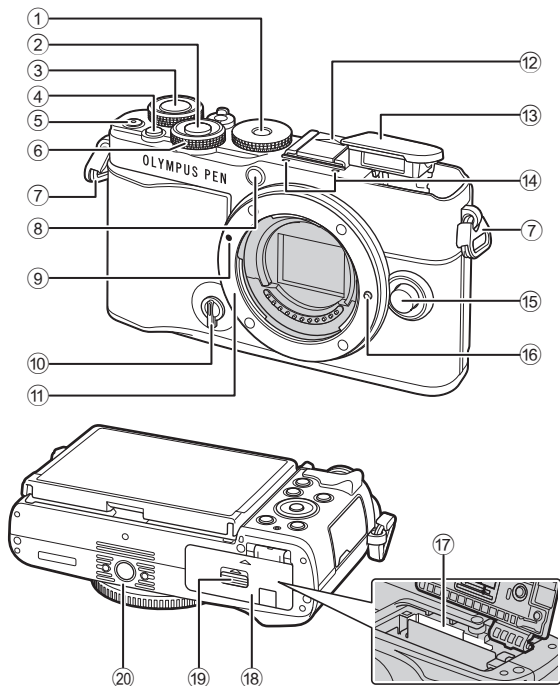

- | | |
|---|--|
| ① Mode dialP. 29 | ⑫ Hot shoe cover |
| ② Shutter buttonP. 30 | ⑬ Built-in flashP. 84 |
| ③ Rear dial (☺).....P. 35-41, 118 | ⑭ Stereo microphoneP. 124, 136 |
| ④ (Shortcut) buttonP. 33 | ⑮ Lens release buttonP. 21 |
| ⑤ (Movie)/ buttonP. 74/P. 122 | ⑯ Lens lock pin |
| ⑥ Front dial (☺).....P. 35-41, 80, 84, 118 | ⑰ Card slotP. 17 |
| ⑦ Strap eyelet.....P. 15 | ⑱ Battery/card compartment cover
.....P. 16, 17 |
| ⑧ Self-timer lamp/AF illuminator
.....P. 86/P. 130 | ⑲ Battery/card compartment lock
.....P. 16, 17 |
| ⑨ Lens attachment markP. 20 | ⑳ Tripod socket |
| ⑩ Profile control switch.....P. 46, 51 | |
| ⑪ Mount (Remove the body cap before
attaching the lens.) | |

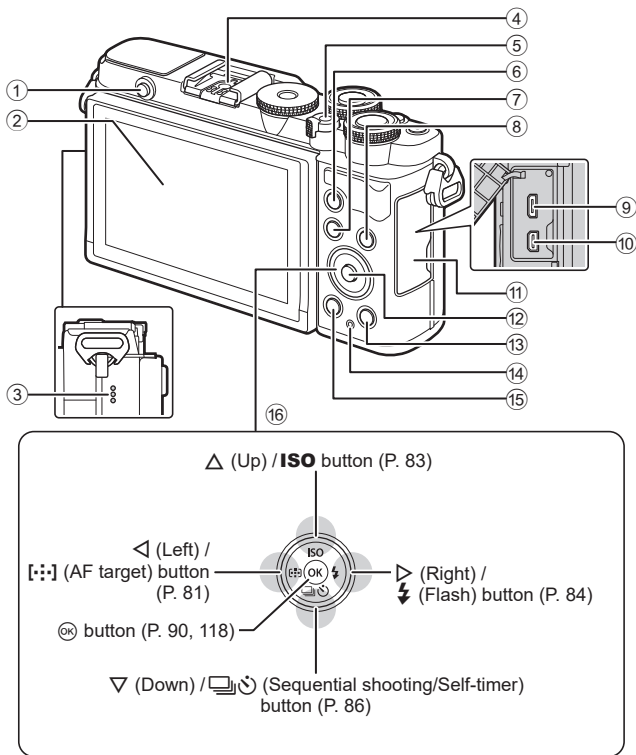

- | | |
|--|--|
| ① Flash pop-up button.....P. 84 | ⑨ Micro-USB connector.....P. 164 |
| ② Monitor (Touch screen)
.....P. 26, 32, 89, 116, 126 | ⑩ HDMI micro connector.....P. 153 |
| ③ Speaker | ⑪ Connector cover |
| ④ Hot shoeP. 169 | ⑫ Ⓞ (OK) buttonP. 91, 118 |
| ⑤ ON/OFF leverP. 22 | ⑬ ▶ (Playback) button.....P. 118 |
| ⑥ AEL/AFL button P. 112, 113, 151 | ⑭ CHARGE (battery charge) lamp....P. 18 |
| ⑦ MENU button.....P. 128 | ⑮ 🗑️ (Erase) buttonP. 121 |
| ⑧ INFO button.....P. 28, 117, 152 | ⑯ Arrow pad* P. 23, 81–86, 118 |

* In this manual, the △▽◀▶ icons represent operations performed using the arrow pad.

Unpacking the box contents

At purchase, the package contains the camera and the following accessories.

If anything is missing or damaged, contact the dealer from whom you purchased the camera.

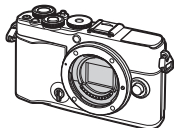

Camera



Body cap*

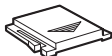

Hot shoe cover*



Strap

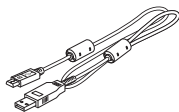

USB cable
CB-USB12



Lithium-ion battery
BLS-50

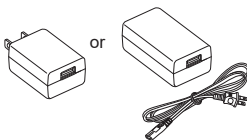

USB-AC adapter F-5AC

Basic Manual

Warranty Card

* The body cap and hot shoe cover are already attached to or inserted into the camera.

Attaching the Strap

- 1 Before attaching the strap, remove the end from the keeper loop and loosen the strap as shown.

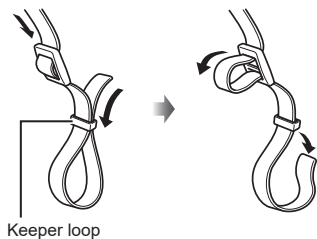

- 2 Pass the end of the strap through the strap eyelet and back through the keeper loop.

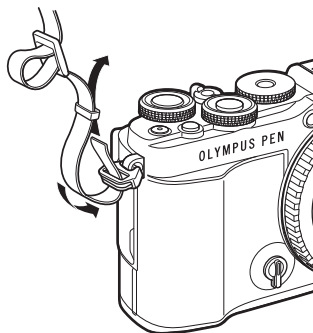

- 3 Pass the end of the strap through the buckle and tighten as shown.

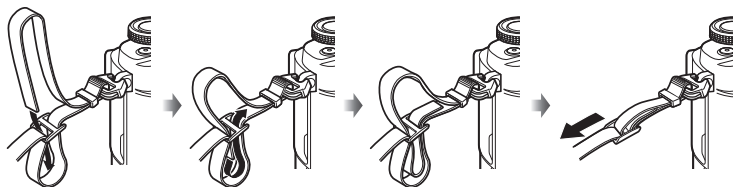

- Attach the other end of the strap to the other eyelet.
- After attaching the strap, pull on it firmly to ensure that it will not come loose.

Inserting and Removing the Battery and Card

In this manual, all storage devices are referred to as “cards.”

The camera uses third-party SD, SDHC, or SDXC memory cards conforming to the SD (Secure Digital) standard.

Cards must be formatted with this camera before first use or after being used with other cameras or computers.  “Formatting the card (Card Setup)” (P. 144)

- 1 Confirm that the **ON/OFF** lever is in the **OFF** position.

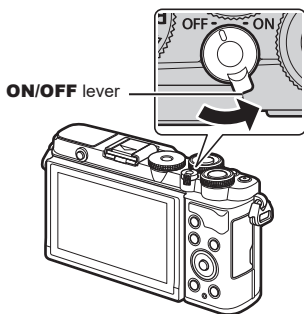

- 2 Opening the battery/card compartment cover.

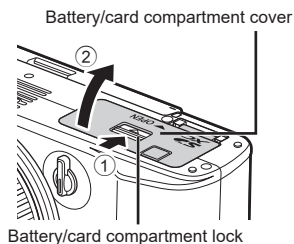

- 3 Loading the battery.
 - Use only BLS-50 batteries (P. 14, 190).

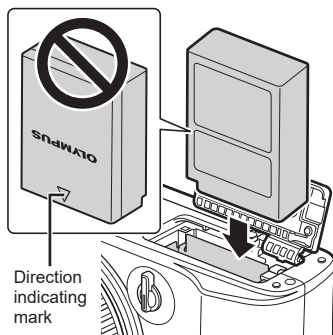

4 Loading the card.

- Slide the card in until it is locked into place.
 "Usable cards" (P. 167)

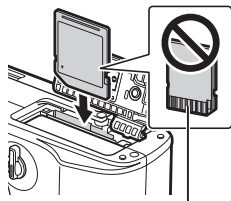

Terminal area

- Do not forcibly insert a damaged or deformed card. Doing so may damage the card slot.

5 Closing the battery/card compartment cover.

- Be sure the battery/card compartment cover is closed before using the camera.

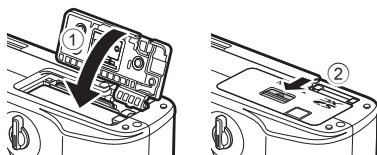

- It is recommended to set aside a backup battery for prolonged shooting in case the battery in use drains.
- Also read "Batteries" (P. 166).

Removing the battery

Turn off the camera before opening or closing the battery/card compartment cover. To remove the battery, first push the battery lock knob in the direction of the arrow and then remove.

- Do not remove the battery while the card write indicator is displayed (P. 26, 27).
- Contact an authorized distributor or service center if you are unable to remove the battery. Do not use force.

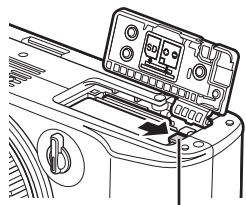

Battery lock knob

Removing the card

Press the inserted card lightly and it will be ejected. Pull out the card.

- Do not remove the battery while the card write indicator is displayed (P. 26, 27).

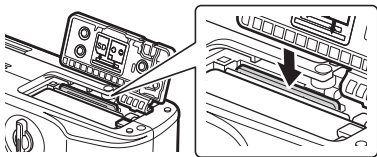

Charging the Battery

1

Preparation

- 1 Confirm that the **ON/OFF** lever is in the **OFF** position.

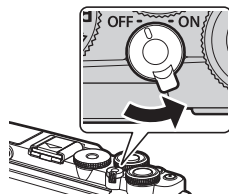

- 2 Check that the battery is in the camera, and connect the USB cable and USB-AC adapter.

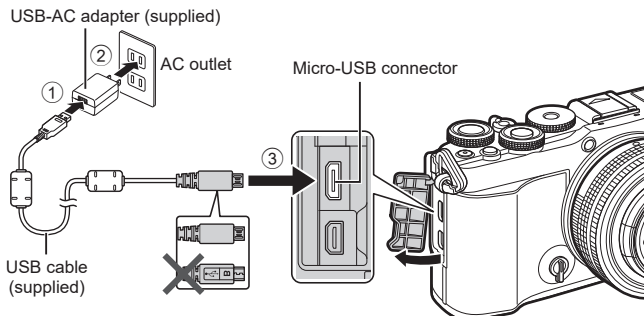

- Never use cable other than the USB cable supplied or specified by our company (P. 172). This may cause smoking or burning.
- The **CHARGE** lamp light during charging. Charging takes about 4 hours. The lamp goes out as the batteries reach full charge.
- Even if charging is in progress, it stops when the camera is turned on.

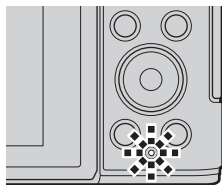

- The USB-AC adapter cannot be used to charge the battery when the camera is on.
- If a charging error occurs, the **CHARGE** lamp will blink. Disconnect and reconnect the USB cable.
- The USB-AC adapter can be used to charge the battery when the battery temperature is between 0 and 40 °C (32 and 104 °F).
- A charger (BCS-5: sold separately) can be used to charge the battery.



- For safety reasons, charging may take longer, or the battery may not reach full charge, when the battery is charged in a high-temperature environment.
- The batteries will not charge while the camera is off if pictures are being uploaded to a smartphone via Wi-Fi (background auto upload).  "Automatically uploading images while the camera is off" (P. 160)



The USB-AC Adapter

- Be sure to unplug the USB-AC adapter for cleaning. Leaving the USB-AC adapter plugged in during cleaning could result in injury or electric shock.

Attaching a lens to the camera

- 1 Confirm that the **ON/OFF** lever is in the **OFF** position.

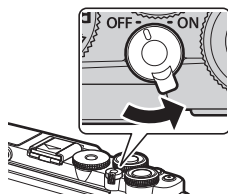

- 2 Remove the rear cap of the lens and the body cap of the camera.

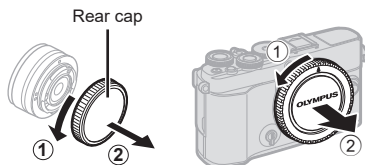

- 3 Align the lens attachment mark (red) on the camera with the alignment mark (red) on the lens, then insert the lens into the camera's body.

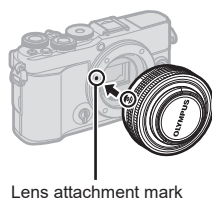

- 4 Rotate the lens as shown until it clicks into place.



- Do not press the lens release button.
- Do not touch internal portions of the camera.

- 5 Remove the front lens cap.

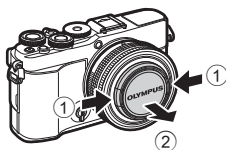
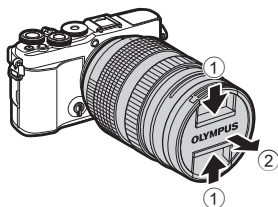

Removing Lenses

- 1 Confirm that the **ON/OFF** lever is in the **OFF** position.

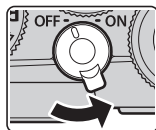

- 2 Hold the lens release button and rotate the lens as shown.

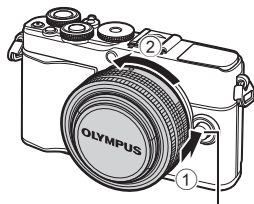

Lens release button

Interchangeable lenses

Read "Interchangeable lenses" (P. 167).

Turning the camera on

- 1 Set the **ON/OFF** lever to the **ON** position.
- When the camera is turned on, the monitor will turn on.
 - To turn the camera off, return the lever to the **OFF** position.

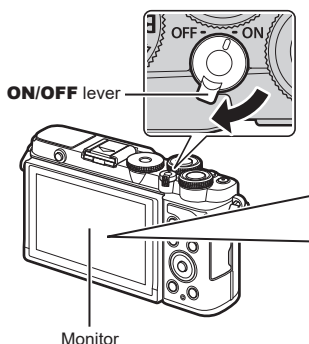

Battery level

The battery level icon will be displayed.

- (green): The camera is ready to shoot.
- (green): The battery is not full.
- (green): The battery is low.
- (blinks red): Charge the battery.



Camera sleep operation

If no operations are performed for a minute, the camera enters "sleep" (stand-by) mode to turn off the monitor and to cancel all actions. Pressing the shutter button reactivates the camera. The camera will turn off automatically if left in sleep mode for 4 hours. Turn the camera on again before use. You can choose how long the camera remains idle before entering sleep mode.  [Sleep] (P. 150)

Initial setup

After turning the camera on for the first time, perform the initial setup by choosing a language and setting the camera clock.

- Date and time information is recorded on the card together with the images.
- The file name is also included with the date and time information. Be sure to set the correct date and time before using the camera. Some functions cannot be used if the date and time have not been set.

- 1 Press the **OK** button when the initial setup dialog is displaying prompting you to choose a language.

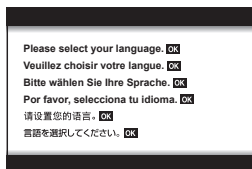

- 2 Highlight the desired language using the front or rear dial or **Δ ▽ < ▷**.

- The language-selection dialog has two pages of options. Use the front or rear dial or **Δ ▽ < ▷** to move the cursor between pages.

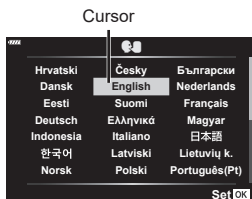

- 3 Press the **OK** button when the desired language is highlighted.

- If you press the shutter button before pressing the **OK** button, the camera will exit to shooting mode and no language will be selected. You can perform the initial setup by turning the camera off and then on again to display the initial setup dialog and repeating the process from Step 1.
- The language can be changed at any time from the **↓** setup menu. **↓** “Choosing a language (🗣️)” (P. 144)



- 4 Set the date, time, and date format.
- Use ◀▶ to highlight items.
 - Use ▲▼ to change the highlighted item.
 - The clock can be adjusted at any time from the ⏰ setup menu. 🖱️ [⏰] (P. 143)

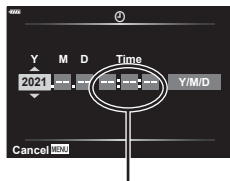

The time is displayed using a 24-hour clock.

- 5 Complete the initial setup.
- Press the Ⓞ button to set the clock.
 - If the battery is removed from the camera and the camera is left for a while, the date and time may be reset to the factory default setting.
 - If you are going to record movies, adjust the frame rate according to the video standard of the country/region. 🖱️ [Video Frame Rate] (P. 136)

Turning the camera off

To turn the camera off, return the **ON/OFF** lever to the **OFF** position. See page 158 for information on how to proceed if the camera displays the dialog shown in the illustration.

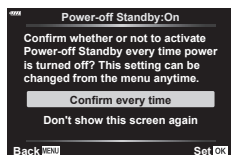
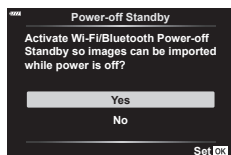

Camera displays unreadable/not in the selected language

If the camera displays are in an unfamiliar language or use characters you are unable to read, you may have accidentally selected the wrong language in the language-selection dialog. Follow the steps below to change languages.

- 1 Press the **MENU** button to display the menus.

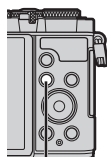

MENU button



- 2 Highlight the **๗** Setup menu tab using Δ ∇ and press \triangleright .

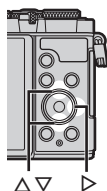

- 3 Highlight [**๐**] using Δ ∇ and press \triangleright .



- 4 Highlight the desired language using Δ ∇ \triangleleft \triangleright and press the **OK** button.



2 Shooting

Information displays while shooting

Monitor display during still photography

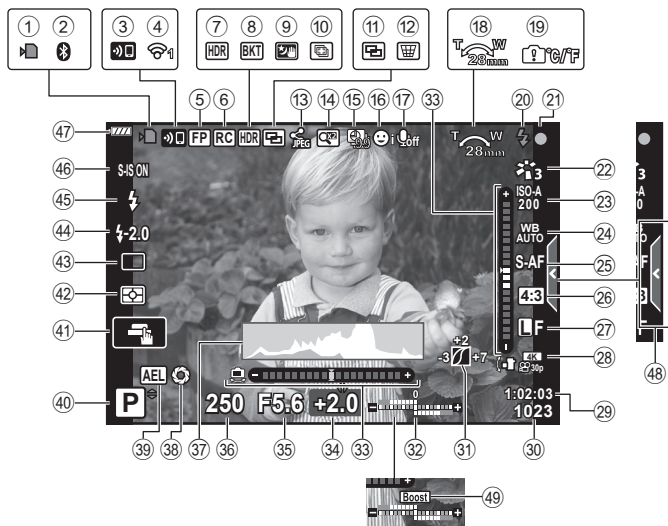

Monitor display during movie mode





- ① Card write indicator.....P. 17
- ② **Bluetooth**® connection status
.....P. 155–163
- ③ Wireless LAN connection starting up
.....P. 155–163
- ④ Wireless LAN connection status
.....P. 155–163
- ⑤ Super FP flash.....P. 169
- ⑥ RC mode.....P. 169
- ⑦ HDR.....P. 64
- ⑧ AE Bracketing.....P. 68
Focus Bracketing.....P. 69
- ⑨ Handheld Starlight.....P. 57
- ⑩ Multi Focus Shot.....P. 59
- ⑪ Multiple exposure.....P. 63, 131
- ⑫ Keystone compensation.....P. 67
- ⑬ Auto Share Order.....P. 160
- ⑭ Digital Tele-converter.....P. 130
- ⑮ Time lapse shooting.....P. 133
- ⑯ Face priority/Eye priority.....P. 82
- ⑰ Movie sound.....P. 136
- ⑱ Zoom operation direction/Focal length
- ⑲ Internal temperature warning.....P. 179
- ⑳ Flash.....P. 84
(blinks: charging in progress, lights up:
charging completed)
- ㉑ AF confirmation mark.....P. 30
- ㉒ Picture mode.....P. 103, 130
- ㉓ ISO sensitivity.....P. 83
- ㉔ White balance.....P. 94
- ㉕ AF mode.....P. 92
- ㉖ Aspect ratio.....P. 97
- ㉗ Image quality (still images).....P. 98
- ㉘ Record mode (movies).....P. 99
- ㉙ Available recording time.....P. 187
- ㉚ Number of storable still pictures...P. 186
- ㉛ Highlight & shadow control.....P. 111
- ㉜ Top: Flash intensity control.....P. 103
Bottom: Exposure compensation....P. 81
- ㉝ Level gauge.....P. 28
- ㉞ Exposure compensation value.....P. 81
- ㉟ Aperture value.....P. 35–41
- ㊱ Shutter speed.....P. 35–41
- ㊲ Histogram.....P. 28
- ㊳ Preview.....P. 112
- ㊴ AE lock.....P. 113, 151
- ㊵ Shooting mode.....P. 29–77
- ㊶ Touch operation.....P. 32
- ㊷ Metering mode.....P. 93
- ㊸ Sequential shooting/Self-timer.....P. 86
Silent shooting.....P. 65
- ㊹ Flash intensity control.....P. 103
- ㊺ Flash mode.....P. 84
- ㊻ Image stabilizer.....P. 96
- ㊼ Battery level.....P. 22
- ㊽ Live guide recall.....P. 54
- ㊾ Live view boost.....P. 146
- ㊿ Recording level meter.....P. 136
- ① Silent shooting tab.....P. 77
- ② Movie (exposure) mode.....P. 115

Switching the information display

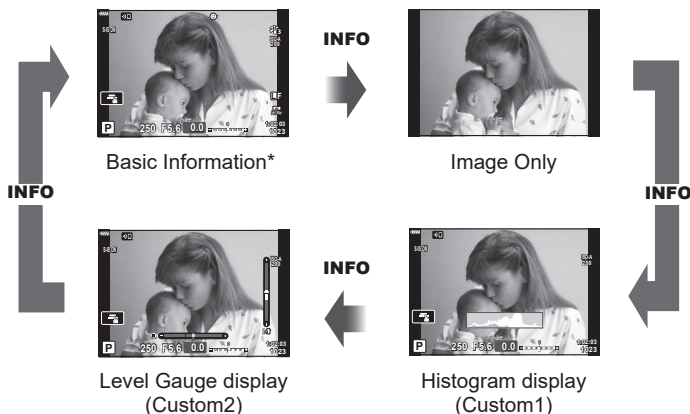
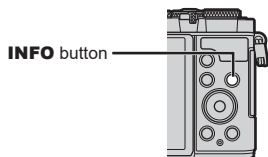
You can switch the information displayed in the monitor during shooting using the **INFO** button.



* Not displayed in  mode (movie mode) unless recording is in progress.

- You can change Custom1 and Custom2 settings.   [Info Settings] > [LV-Info] (P. 146)
- The information display screens can be switched in either direction by rotating the front dial while pressing the **INFO** button.

Histogram display

A histogram showing the distribution of brightness in the image is displayed. The horizontal axis gives the brightness, the vertical axis the number of pixels of each brightness in the image. During shooting, overexposure is indicated in red, underexposure in blue, and the range metered using spot metering in green.

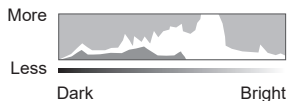

Level gauge display

The orientation of the camera is indicated. The “tilt” direction is indicated on the vertical bar and the “horizon” direction on the horizontal bar. The camera is level and plumb when the bars turn green.

- Use the indicators on the level gauge as a guide.
- Error in the display can be corrected via calibration (P. 150).

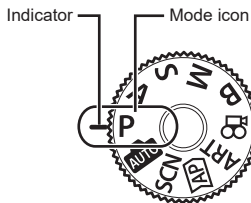

Choosing a shooting mode and taking photos

Use the mode dial to select the shooting mode, and then shoot the image.



Types of shooting modes

For how to use the various shooting modes, see the following.

P	Program AE (P. 35)
A	Aperture-priority AE (P. 37)
S	Shutter-priority AE (P. 39)
M	Manual exposure (P. 41)
B	Bulb/time (P. 42)
	Live composite (P. 44)
	AUTO (P. 54)
SCN	Scene (P. 56)
	Advanced photo (P.60)
ART	Art filter (P. 70)
	Movie (P. 75)

Functions that cannot be selected from menus

Some items may not be selectable from the menus using Δ ∇ \langle \rangle .

- Items that cannot be set with the current shooting mode.
- Items that cannot be set because of an item that has already been set:

Settings such as picture mode are unavailable when the mode dial is rotated to .

- 1 Rotate the mode dial to a mode.

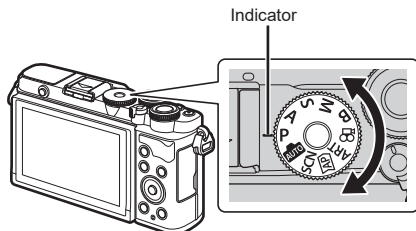

- 2 Frame the shot.

- Be careful that your fingers or the camera strap do not obstruct the lens or AF illuminator.

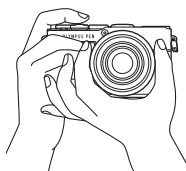

Landscape position

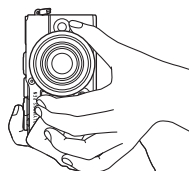

Portrait position

- 3 Adjust the focus.

- Display the subject in the center of the monitor, and lightly press the shutter button down to the first position (press the shutter button halfway). The AF confirmation mark (●) will be displayed, and a green frame (AF target) will be displayed in the focus location.

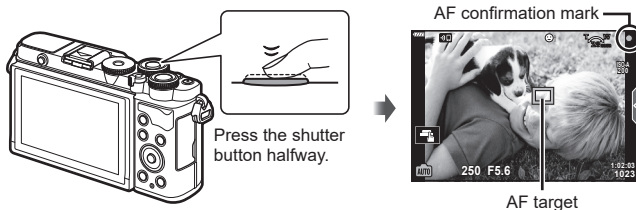

- If the AF confirmation mark blinks, the subject is not in focus (P. 176).

- 4 Release the shutter.

- Press the shutter button all the way (fully).
- The camera will release the shutter and take a picture.
- The shot image will be displayed on the monitor.

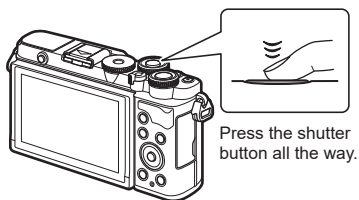

- You can focus and take pictures using touch controls.  "Shooting with touch screen operations" (P. 32)
- To exit to shooting mode from menus or playback, press the shutter button halfway.

Taking high angle and low angle shots

You can change the orientation and angle of the monitor.

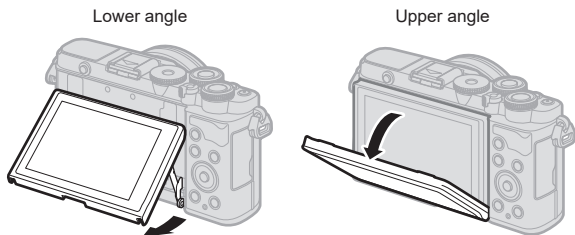

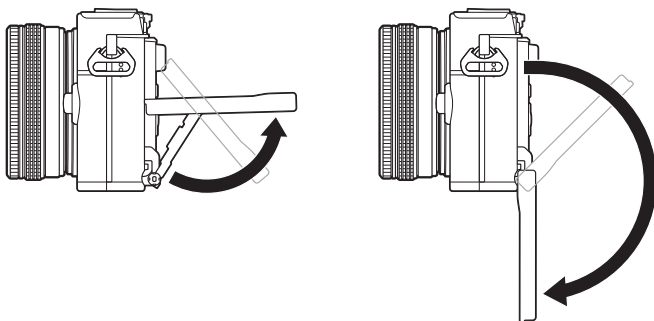

Rotating the Monitor: Cautions

- Rotate the monitor gently within the limits shown. Do not use force; failure to observe this precaution could damage the connectors.

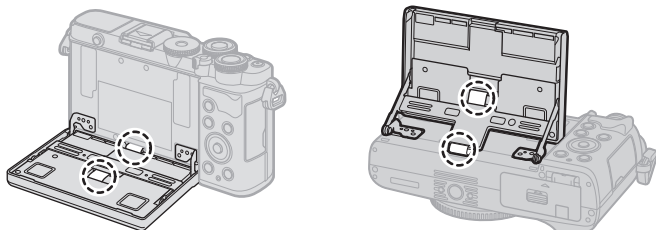

- Do not touch the areas indicated in the illustration. Failure to observe this precaution could damage the product or cause it to malfunction.





- Inverting the monitor allows you to take pictures of yourself while you preview the frame.  "Taking Photos in Self-Portrait Mode" (P. 78)

Shooting with touch screen operations

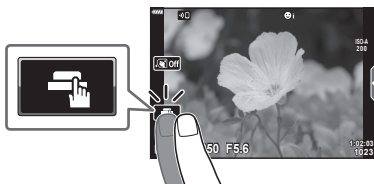
Tap  to cycle through touch screen settings.





	Tap a subject to focus and automatically release the shutter. This feature is not available in movie mode and during bulb, time, or composite photography.
	Touch screen operations are disabled.
	Tap to display an AF target and focus on the subject in the selected area. Photographs can be taken by pressing the shutter button.

■ Previewing the subject ()

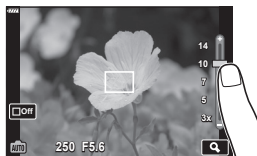
- Tap the subject in the display.
 - An AF target will be displayed.
 - Use the slider to choose the size of the frame.
 - Tap  to turn off the display of the AF target.



- Tap  to zoom in at the frame position.
 - Use your finger to scroll the display when the picture is zoomed in.
 - Tap  to cancel the zoom display.
 - You cannot resize or zoom in on the target in movie mode.

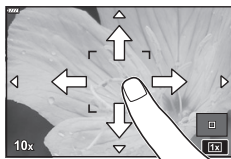

- The situations in which touch screen operations are not available include the following.
 - One-touch WB, while buttons or dials are in use, etc.
- Do not touch the display with your fingernails or other sharp objects.
- Gloves or monitor covers may interfere with touch screen operation.
- You can disable the touch screen operation.  [Touchscreen Settings] (P. 150)

Switching Displays with the (Shortcut) Button

Press the  button to switch to each screen of the selected shooting mode between shots.

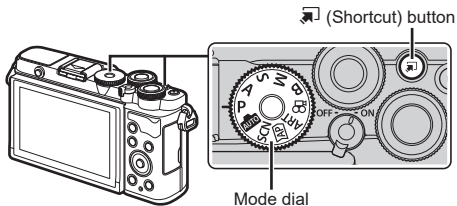

P/A/S/M/B

- When the profile control switch is not in the COLOR/MONO position

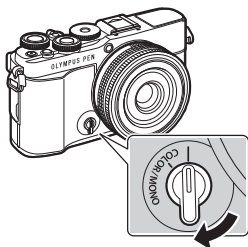

Profile control switch

LV super control panel (P. 89)



- When the profile control switch is in the COLOR/MONO position

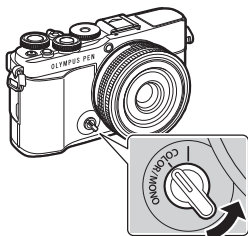

Profile control switch

Profile Control (P. 46)



Live guide (P. 54)



SCN

Scene mode (P. 56)

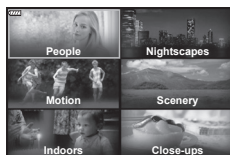



Advanced photo mode (P. 60)



Movie mode (P. 75)



ART

Art filter mode (P. 70)



Letting the camera choose aperture and shutter speed (Program mode)

The camera chooses the optimal aperture and shutter speed according to subject brightness.

1 Rotate the mode dial to **P**.

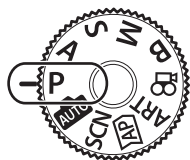

2 Focus and check the display.

- The shutter speed and aperture chosen by the camera are displayed.



Shutter speed
Aperture
Shooting mode

3 Take pictures.

- You can use the front dial to select exposure compensation.
- You can use the rear dial to select program shift.
- The shutter speed and aperture value displays will blink if the camera is unable to achieve correct exposure.

The aperture value at the moment when its indication blinks varies with the lens type and focal length of the lens.

When using a fixed [ISO] setting, change the setting. "Changing ISO sensitivity (ISO)" (P. 83)

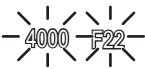
Warning display example (blinking)	Status	Action
	The subject is too dark.	Use the flash.
	The subject is too bright.	<ul style="list-style-type: none"> The metered range of the camera is exceeded. A commercially available ND filter (for adjusting the amount of light) is required. Take pictures in silent mode. "The Electronic Shutter (Silent [♥])" (P. 88)



- You can choose processing options using the profile control. Rotate the profile control switch to the COLOR/MONO position to display the profile control. When the profile control is not display while the profile control switch is in the COLOR/MONO position, press button to display the control. “Shooting enhanced images (Profile Control)” (P. 46)
- You can choose the functions performed by the front and rear dials. [Dial Function] (P. 145)
- You can choose whether the display reflects the effects of exposure compensation or maintains a constant brightness for ease of viewing. At default settings, the effects of exposure settings are visible in the display. [Live View Boost] (P. 146)

■ Program Shift

Without changing exposure, you can choose from different combinations of aperture and shutter speed selected automatically by the camera. This is known as program shift.

- Rotate the rear dial until the camera displays the desired combination of aperture and shutter speed.
- The shooting mode indicator in the display changes from **P** to **Ps** while program shift is in effect. To end program shift, rotate the rear dial in the opposite direction until **P** is no longer displayed.



Program shift

In this mode, you choose the aperture (f/-number) and the camera automatically sets the shutter speed for optimal exposure according to subject brightness. Lower aperture values (larger apertures) reduce the depth of the area that appears to be in focus (depth of field), blurring the background. Higher aperture values (smaller apertures) increase the depth of the area that appears to be in focus in front of and behind the subject.

Lower aperture values...



...reduce depth of field and increase blur.

Higher aperture values...



...increase depth of field.

1 Rotate the mode dial to **A**.

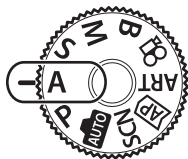

2 Choose an aperture.

- At default settings, aperture is selected by rotating the rear dial.
- The shutter speed selected automatically by the camera will appear in the display.
- You can use the front dial to select exposure compensation.







Aperture value

3 Take pictures.

- The shutter speed display will blink if the camera is unable to achieve correct exposure. When using a fixed [ISO] setting, change the setting. "Changing ISO sensitivity (ISO)" (P. 83)

Warning display example (blinking)	Status	Action
F5.6	The subject is underexposed.	Decrease the aperture value.
F5.6	The subject is overexposed.	<ul style="list-style-type: none"> • Increase the aperture value. • If the warning display does not disappear, the metered range of the camera is exceeded. A commercially available ND filter (for adjusting the amount of light) is required. • Take pictures in silent mode. "The Electronic Shutter (Silent [♥])" (P. 88)



- You can choose processing options using the profile control. Rotate the profile control switch to the COLOR/MONO position to display the profile control. When the profile control is not display while the profile control switch is in the COLOR/MONO position, press  button to display the control.  “Shooting enhanced images (Profile Control)” (P. 46)
- You can choose the functions performed by the front and rear dials.  [Dial Function] (P. 145)
- You can choose whether the display reflects the effects of exposure compensation or maintains a constant brightness for ease of viewing. At default settings, the effects of exposure settings are visible in the display.  [Live View Boost] (P. 146)

In this mode, you choose the shutter speed and the camera automatically sets aperture for optimal exposure according to subject brightness. Faster shutter speeds appear to “freeze” fast-moving subjects. Slower shutter speeds add blur to moving objects, lending them a sense of motion for a dynamic effect.

Slower shutter speeds...



...produce dynamic shots with a sense of motion.

Faster shutter speeds...



...“freeze” the motion of fast-moving subjects.

1 Rotate the mode dial to **S**.

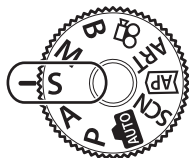

2 Choose a shutter speed.

- At default settings, shutter speed is selected by rotating the rear dial.
- Shutter speed can be set to values between 1/4000 and 60 s.
- Shutter speeds as fast as 1/16000 s are available in [♥] (silent) mode. “The Electronic Shutter (Silent [♥])” (P. 88)
- The aperture selected automatically by the camera will appear in the display.
- You can use the front dial to select exposure compensation.



Shutter speed

3 Take pictures.

- The aperture value display will blink if the camera is unable to achieve correct exposure. The aperture value at the moment when its indication blinks varies with the lens type and focal length of the lens.
- When using a fixed [ISO] setting, change the setting. “Changing ISO sensitivity (ISO)” (P. 83)

Warning display example (blinking)	Status	Action
	The subject is underexposed.	Set the shutter speed slower.
	The subject is overexposed.	<ul style="list-style-type: none"> Choose a faster shutter speed. Shutter speeds as fast as 1/16000 s are available in silent mode. “The Electronic Shutter (Silent [♥])” (P. 88) If the warning display does not disappear, the metered range of the camera is exceeded. A commercially available ND filter (for adjusting the amount of light) is required.



- You can choose processing options using the profile control. Rotate the profile control switch to the COLOR/MONO position to display the profile control. When the profile control is not display while the profile control switch is in the COLOR/MONO position, press button to display the control. “Shooting enhanced images (Profile Control)” (P. 46)
- You can choose the functions performed by the front and rear dials. [Dial Function] (P. 145)
- You can choose whether the display reflects the effects of exposure compensation or maintains a constant brightness for ease of viewing. At default settings, the effects of exposure settings are visible in the display. [Live View Boost] (P. 146)

Choosing aperture and shutter speed (Manual mode)

In this mode, you choose the aperture and shutter speed. You can adjust settings according to your goals, for example by combining fast shutter speeds with small apertures (high *f*-numbers) for increased depth of field.

1 Rotate the mode dial to **M**.

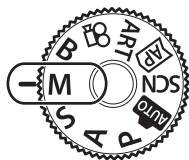

2 Adjust aperture and shutter speed.

- At default settings, aperture is selected with the front dial and shutter speed with the rear dial.
- The exposure determined by the aperture value and shutter speed you have set and the difference from the suitable exposure measured by the camera are displayed on the monitor.
- Shutter speed can be set to values between 1/4000 and 60 seconds.
- Shutter speeds as fast as 1/16000 s are available in [♥] (silent) mode. "The Electronic Shutter (Silent [♥])" (P. 88)



3 Take pictures.



- You can choose processing options using the profile control. Rotate the profile control switch to the COLOR/MONO position to display the profile control. When the profile control is not display while the profile control switch is in the COLOR/MONO position, press button to display the control. "Shooting enhanced images (Profile Control)" (P. 46)
- You can choose the functions performed by the front and rear dials. [Dial Function] (P. 145)
- The brightness of the image displayed in the monitor will change with changes in aperture and shutter speed. You can fix the brightness of the display so that you can keep the subject in view while shooting. [Live View Boost] (P. 146)

Leave the shutter open for a long exposure. You can preview the photo in live view and end the exposure when the desired results have been achieved. Use when long exposures are required, for example when photographing night scenes or fireworks.

“Bulb” and “Live Bulb” Photography

The shutter remains open while the shutter button is pressed. Releasing the button ends the exposure.

- When live bulb photography is selected, you can choose how often the camera updates the live view display during the exposure.

“Time” and “Live Time” Photography

The exposure begins when the shutter button is pressed all the way down. To end the exposure, press the shutter button all the way down a second time.

- When live time photography is selected, you can choose how often the camera updates the live view display during the exposure.

1 Rotate the mode dial to **B**.

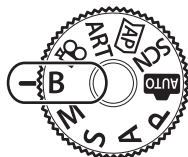

2 Select [BULB]/[LIVE BULB] (bulb photography) or [TIME]/[LIVE TIME] (time photography).

- At default settings, the selection is made with the rear dial.

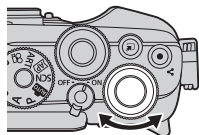

Bulb or time photography

3 Press the **MENU** button.

- You will be prompted to choose the interval at which the preview is updated.

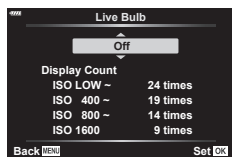

4 Highlight an interval using Δ ∇ .

- 5 Press the **OK** button to select the highlighted option.
 - The menus will be displayed.
- 6 Press the **MENU** button to exit the menus.
 - If an option other than [Off] is selected, [LIVE BULB] or [LIVE TIME] will appear in the display.
- 7 Adjust aperture.
 - At default settings, aperture can be adjusted using the front dial.



Aperture

- 8 Take pictures.
 - In bulb and live bulb modes, keep the shutter button pressed. The exposure ends when the button is released.
 - In time and live time modes, press the shutter button all the way down once to start the exposure and again to end it.
 - The exposure ends automatically when the time selected for [Bulb/Time Timer] is reached. The default is [8 min]. The time can be changed. [Bulb/Time Timer] (P. 147)
 - [Noise Reduct.] is applied after shooting. The display shows the time remaining until the process is complete. You can choose the conditions under which noise reduction is performed (P. 147).
- During live time photography, you can refresh the preview by pressing the shutter button halfway.
- Some limitations apply to the choice of ISO sensitivity settings available.
- During shooting, there are limits on the settings for the following functions.
 - Sequential shooting, self-timer shooting, time lapse shooting, image stabilizer, multiple exposure^{*1,2}, etc.
 - *1 When an option other than [Off] is selected for [Live Bulb] or [Live Time] (P. 147)
 - *2 When the profile control switch is in the COLOR/MONO position (P. 46)
- [Image Stabilizer] (P. 96) turns off automatically.
- Depending on camera settings, the temperature, and the situation, you may notice noise or bright spots in the monitor. These may sometimes appear in pictures even when [Noise Reduct.] (P. 147) is enabled.

Noise in images

When shooting at slow shutter speeds, noise may appear in images. This phenomenon occurs when the temperature rises in the image pickup device or image pickup device internal drive circuit, causing current to be generated in those sections of the image pickup device that are not normally exposed to light. This can also occur when shooting with a high ISO setting in a high-temperature environment. To reduce this noise, the camera activates the noise reduction function. [Noise Reduct.] (P. 147)



- During bulb/time photography, the brightness of the subject in the display is enhanced for ease of viewing when lighting is poor. [Live View Boost] (P. 146)

Lighten Blending

(Live Composite Photography)

Leave the shutter open for a long exposure. You can view the light trails left by fireworks or stars and photograph them without changing the exposure of the background. The camera combines multiple shots and records them as a single photograph.

2

Shooting

1 Rotate the mode dial to **B**.

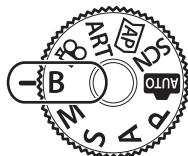

2 Select [LIVE COMP] (live composite photography).
• At default settings, the selection is made with the rear dial.

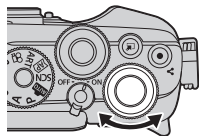

Live composite photography

3 Press the **MENU** button.
• The [Composite Settings] menu will be displayed.

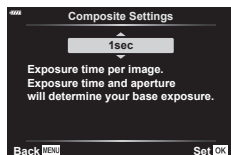

- 4 Highlight an exposure time using $\Delta \nabla$.
• Choose an exposure time of from 1/2 to 60 s.
- 5 Press the **OK** button to select the highlighted option.
• The menus will be displayed.
- 6 Press the **MENU** button repeatedly to exit the menus.
- 7 Adjust aperture.
• At default settings, aperture can be adjusted using the front dial.

8 Press the shutter button all the way down to ready the camera.

- The camera is ready to shoot when [Ready for composite shooting] is displayed.



9 Press the shutter button to start shooting.

- Live composite photography will start. The display will be updated after each exposure.

10 Press the shutter button again to end shooting.

- Live composite photography can continue for up to three hours. The maximum recording time available varies with battery level and shooting conditions.
- Some limitations apply to the choice of ISO sensitivity settings available.
- To reduce blur caused by camera shake, fix the camera securely to a tripod and use a remote shutter release controlled via Ol.Share (P. 161).
- During shooting, there are limits on the settings for the following functions. Sequential shooting, self-timer shooting, time lapse shooting, image stabilizer, multiple exposure, etc.
- [Image Stabilizer] (P. 96) turns off automatically.



- The exposure time for each exposure made during live composite photography can be chosen in advance using the menus. Custom Menu **D2** > [Composite Settings] (P. 147)

Use the profile control switch to switch to profile control photography.

You can choose image enhancement options on the profile control screen.

- Profile control photography is available only when the mode dial is rotated to **P**, **A**, **S**, **M**, or **B**.
- Some functions such as multiple exposures cannot be used with this function.
- If [RAW] is currently selected for image quality, image quality will automatically be set to RAW+JPEG.
- Touch controls can also be used.

Shooting enhanced monochrome pictures

(Monochrome Profile Control)

You can apply a color filter effect to monochrome pictures (Color Filter Effect), change the amount of peripheral light (Shading), and adjust bright and dark areas of the picture (Highlight&Shadow Control).

- 1 Rotate the profile control switch to COLOR/MONO.
 - The profile control screen will be displayed.

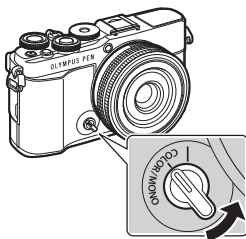

- 2 Choose a profile using Δ / ∇ and choose one from [Mono1] to [Mono4] using \triangleleft / \triangleright .
 - You can use the rear dials to select [Mono1/2/3/4].
 - The following are presets for [Mono1] to [Mono4].



Profile

Mono1	Monochrome Profile 1	A standard "Monochrome" preset with all settings reset to their default values (± 0)
Mono2	Monochrome Profile 2	A preset that produces the effect of black-and-white film
Mono3	Monochrome Profile 3	A preset that produces the effect of infrared black-and-white film
Mono4	Monochrome Profile 4	A preset that reduces the contrast to make your photo look soft

- 3** Use Δ ∇ to choose an option and adjust the settings (P. 48).
- 4** Press the OK button.
- 5** Shoot.
 - To go back to the profile control screen, press the RECALL button.

Image enhancement options for monochrome profile control

■ Color Filter Effect

You can apply a color filter effect to monochrome pictures, choosing from eight colors and three intensity levels.

- 1 Choose Color Filter Effect using $\Delta \nabla$ on the profile control screen.
 - Press and hold the OK button to restore the default color filter effect.



Color Filter Effect

- 2 Choose the color of the filter using the front dial and the intensity using the rear dial.

- When a setting is changed, “**” is displayed to the right of the option icon.
- The settings are saved as the current profile ([Mono1] to [Mono4]).



■ Shading Editor

You can adjust the peripheral illumination of pictures.

- 1 Choose Shading Editor using $\Delta \nabla$ on the profile control screen.
 - Use the front dial to adjust shading.
 - Press and hold the OK button to restore the default shading setting.



Shading Editor

- When a setting is changed, “**” is displayed to the right of the option icon.
- The settings are saved as the current profile ([Mono1] to [Mono4]).



■ Highlight&Shadow Control

Adjust brightness separately for highlights, mid-tones, and shadows. You gain greater control over exposure than you would with exposure compensation alone. You can selectively make highlights darker or shadows brighter.

- 1 Choose Highlight&Shadow Control using $\Delta \nabla$ on the profile control screen.

- Press and hold the OK button to restore the default highlight&shadow.

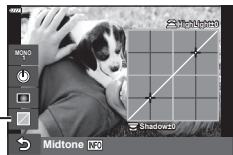

Highlight&Shadow Control

- 2 Press the **INFO** button to choose the desired tone range.

- The tone range changes each time the button is pressed.



Selected tone range

- 3 Rotate the dials to choose the desired setting.

- **[Hi. & Sh.] (Highlight&Shadow) selected**
Adjust highlights using the front dial and shadows using the rear dial.
- **[Midtone] selected**
Use the front or rear dial.

- When a setting is changed, "*" is displayed to the right of the option icon.
- The settings are saved as the current profile ([Mono1] to [Mono4]).

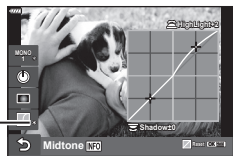

- In addition to Color Filter/Shading/Highlight&Shadow, you can also adjust the granular feeling, color, etc. of the image.
Film Grain Effect (P. 107)/Sharpness (P. 106)/ Monochrome Color (P. 109)/ Contrast (P. 106)

- When you choose a profile on the profile control screen using Δ ∇ and press and hold the \odot button, the Color Filter (P. 48)/Shading (P. 48)/Highlight&Shadow (P. 49) settings for the selected profile ([Mono1/2/3/4]) reset to the default values. The following settings also reset to the default values at the same time.

Film Grain Effect (P. 107)/Sharpness (P. 106)/
Monochrome Color (P. 109)/ Contrast (P. 106)



Profile

Shooting pictures with individual colors adjusted

(Color Profile Control)

You can adjust the saturation of each color (Saturation Level), change the amount of peripheral light (Shading), and adjust bright and dark areas of the picture (Highlight&Shadow Control).

- 1 Rotate the profile control switch to COLOR/MONO.
 - The profile control screen will be displayed.

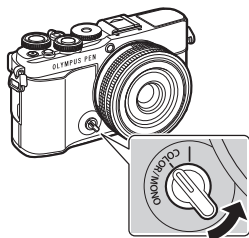

- 2 Choose a profile using Δ ∇ and choose one from [Color1] to [Color4] using \triangleleft \triangleright .
 - You can use the rear dials to select [Color1/2/3/4].
 - The following are presets for [Color1] to [Color4].



Profile

Color 1	Color Profile 1	A standard "Natural" preset with all settings reset to their default values (± 0)
Color 2	Color Profile 2	A preset with deep, austere colors
Color 3	Color Profile 3	A preset that gives the effect of film with highly saturated, deep colors
Color 4	Color Profile 4	A preset with light and soft tones

- 3 Use Δ ∇ to choose an option and adjust the settings (P. 52).
- 4 Press the OK button.
- 5 Shoot.
 - To go back to the profile control screen, press the MENU button.

Image enhancement options for color profile control

■ Saturation Level

The saturation of twelve different colors can be adjusted by up to ± 5 while checking the effect on the screen.

- 1 Choose Saturation Level using $\Delta \nabla$ on the profile control screen.
 - Press and hold the OK button to restore the default saturation level.



Saturation Level

- 2 Set the hue using the front dial and the saturation using the rear dial.
 - Modifications made with [Color All] displayed above the Color Profile Control apply to all colors.
 - To modify all colors simultaneously, press the **INFO** button and rotate the rear dial to adjust the saturation.
- When a setting is changed, “**” is displayed to the right of the option icon.
 - The settings are saved as the current profile ([Color1] to [Color4]).



■ Shading Editor

You can adjust the peripheral illumination of pictures.

- 1 Choose Shading Editor using $\Delta \nabla$ on the profile control screen.
 - Use the front dial to adjust shading.
 - Press and hold the OK button to restore the default shading setting.

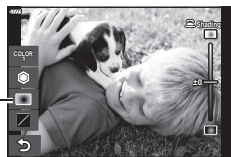

Shading Editor

- When a setting is changed, “**” is displayed to the right of the option icon.
- The settings are saved as the current profile ([Color1] to [Color4]).



■ Highlight&Shadow Control

Adjust brightness separately for highlights, mid-tones, and shadows. You gain greater control over exposure than you would with exposure compensation alone. You can selectively make highlights darker or shadows brighter.

- 1 Choose Highlight&Shadow Control using $\Delta \nabla$ on the profile control screen.
 - Press and hold the OK button to restore the default highlight&shadow.

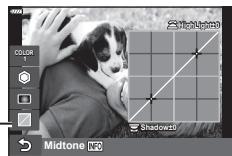

Highlight&Shadow Control

- 2 Press the **INFO** button to choose the desired tone range.
 - The tone range changes each time the button is pressed.



Selected tone range

- 3 Rotate the dials to choose the desired setting.
 - **[Hi. & Sh.] (Highlight&Shadow) selected**
Adjust highlights using the front dial and shadows using the rear dial.
 - **[Midtone] selected**
Use the front or rear dial.

- When a setting is changed, “**” is displayed to the right of the option icon.
- The settings are saved as the current profile ([Color1] to [Color4]).

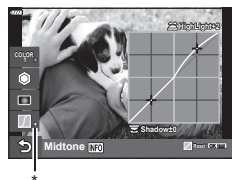

- In addition to Color Profile/Shading/Highlight&Shadow, you can also adjust the sharpness and/or contrast of the image.
Sharpness (P. 106)/Contrast (P. 106)
- When you choose a profile on the profile control screen using $\Delta \nabla$ and press and hold the OK button, the Color Profile (P. 52)/Shading (P. 52)/Highlight&Shadow (P. 53) settings for the selected profile ([Color1]/[2/3/4]) reset to the default values. The following settings also reset to the default values at the same time.
Sharpness (P. 106)/Contrast (P. 106)



Profile

Letting the camera choose the settings (AUTO mode)

The camera adjusts settings to suit the scene; all you have to do is press the shutter button.

Use live guides to easily adjust such parameters as color, brightness, and background blurring.

2

Shooting

1 Set the mode dial to **AUTO**.

- In auto mode, the camera automatically selects the scene mode option appropriate to your subject when you press the shutter button halfway. Once the selection has been made, the **AUTO** icon in the bottom left corner of the display will be replaced by the icon for the chosen scene.

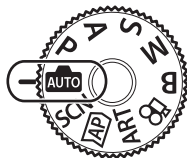

2 To adjust shooting settings, display the live guide by pressing the **INFO** button.

- Use Δ / ∇ to highlight an item in the live guide and press **OK** to display a slider.



Guide item

3 Use Δ / ∇ to position the slider and choose a level.

- Press the **OK** button to save changes.
- To exit, press the **MENU** button.
- When [Shooting Tips] is selected, use Δ / ∇ to highlight the item and press the **OK** button to display the detail.
- The effect of the selected level is visible in the display.
If [Blur Background] or [Express Motions] is selected, the display will return to normal, but the selected effect will be visible in the final photograph.



Slider

4 To set multiple live guides, repeat Steps 2 and 3.

- A check is displayed on the guide item for live guides that are already set.
- [Blur Background] and [Express Motions] cannot be set at the same time.



5 Shoot.

- To clear the live guides from the display, press the **MENU** button.
- If [RAW] is currently selected for image quality, image quality will automatically be set to RAW+JPEG.
- Certain live guide settings are not applied to the RAW copy.
- Pictures may appear grainy at some live guide setting levels.
- Changes to live guide setting levels may not be visible in the monitor.
- Frame rates drop the closer the [Express Motions] slider is to [Blurred Motion].
- The flash cannot be used when a live guide is set.
- Choosing live guide settings that exceed the limits of the camera exposure meters may result in pictures that are overexposed or underexposed.



- Touch controls can also be used.

One-Touch e-Portrait

To enable one-touch e-Portrait so that the camera smooths the complexions of portrait subjects, tap the

Off (one-touch e-Portrait) icon to turn it on (On).

"Taking Photos in Self-Portrait Mode" (P. 78)



One-touch e-Portrait icon

Shooting in scene mode

(SCN mode)

The camera automatically optimizes settings for the subject or scene.

- 1 Rotate the mode dial to **SCN**.

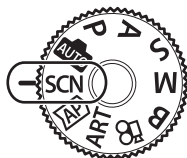

- 2 Use Δ ∇ \triangleleft \triangleright to highlight a scene and press the $\text{\textcircled{OK}}$ button.



- 3 Use \triangleleft \triangleright to highlight a scene mode and press the $\text{\textcircled{OK}}$ button.
 - Press the $\text{\textcircled{A}}$ button to choose a different scene.

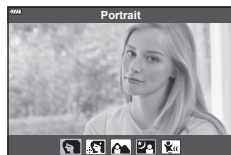













- 4 Shoot.

















- Touch controls can also be used.



Types of scene modes

Subject type	Scene mode	Description
People	 Portrait	Suitable for portrait shooting. Brings out skin texture.
	 e-Portrait	Smooths out skin tones and texture. The camera records two pictures: one with the effect applied and one without.
	 Portrait + Landscape	Suitable for portrait shooting with a landscape in the background. Focuses from near to far.
	 Portrait + Nightscape	Suitable for portrait shooting against a background of night view. Raise the flash (P. 84). Use of a tripod and remote control via OI.Share is recommended (P. 161).
	 Children	Suitable for photographs of children and other active subjects.

Subject type	Scene mode	Description
Nightscapes	 Nightscape	Suitable for tripod shooting of night scenes. Use of a tripod and remote control via OI.Share is recommended (P. 161).
	 Portrait + Night Landscape	Suitable for portrait shooting against a background of night view. Raise the flash (P. 84). Use of a tripod and remote control via OI.Share is recommended (P. 161).
	 Handheld Starlight	Suitable for shooting night scenes without a tripod. Reduces blur when shooting low light/illuminated scenes. The camera makes eight exposures and combines them into a single photograph.
	 Fireworks	Suitable for shooting fireworks at night. Use of a tripod and remote control via OI.Share is recommended (P. 161).
	 Light Trails	The camera automatically shoots multiple images, takes newly bright areas only, and composites them into a single image. With normal long exposure, an image of light trace such as star trails with bright buildings tends to get too bright. You can capture them without over exposure while checking the progress. Press the shutter button to start shooting, then view the changing result in the monitor and press the shutter button again to end shooting once the desired result is achieved (maximum 3 hours). Use of a tripod and remote control via OI.Share is recommended (P. 161). <ul style="list-style-type: none"> For information on taking photos using this feature, see “[Live Composite]: Live Composite Photography” (P. 61), starting from Step 2. Advanced settings can be accessed via live composite photography (dark and light field composite) in B mode (P. 44).
Motion	 Sport	Suitable for fast action shooting. The camera will take photos while the shutter button is pressed.
	 Children	Suitable for photographs of children and other active subjects.
	 Panning	Choose to blur the background behind moving objects. The camera chooses the optimal shutter speed for panning shots based on camera motion.

Subject type	Scene mode	Description
Scenery	 Landscape	Suitable for shooting landscapes. Emphasizes sharpness and contrast.
	 Sunset	Suitable for shooting the setting/rising sun. Reproduces colors vividly.
	 Beach & Snow	Suitable for shooting snow-capped mountains, landscapes, white sand beaches, etc.
	 Panorama	Take panoramic photos with a wider angle of view than other shots. • For information on taking photos using this feature, see “Shooting a Panorama” (P. 66), starting from Step 3.
	 Backlight HDR	Suitable for high-contrast scenes. Each time the shutter button is pressed, the camera takes four shots and subsequently merges them into one, correctly exposed image. • For information on taking photos using this feature, see “[HDR]: Taking Composite Photos with HDR” (P. 64), starting from Step 3.
Indoors	 Candlelight	Suitable for shooting in candlelight. Creates a soft atmosphere.
	 Silent [♥]	Disable camera sounds and lights in situations in which they may be unwelcome. • For information on taking photos using this feature, see “[Silent [♥]] Mode” (P. 65), starting from Step 2.
	 Portrait	Suitable for portrait shooting. Brings out skin texture.
	 e-Portrait	Smooths out skin tones and texture. The camera records two pictures: one with the effect applied and one without.
	 Children	Suitable for photographs of children and other active subjects.
	 Backlight HDR	Suitable for high-contrast scenes. Each time the shutter button is pressed, the camera takes four shots and subsequently merges them into one, correctly exposed image. • For information on taking photos using this feature, see “[HDR]: Taking Composite Photos with HDR” (P. 64), starting from Step 3.

Subject type	Scene mode	Description
Close-ups	 Macro	Suitable for close-ups.
	 Nature Macro	Suitable for vivid close-ups of flowers or insects.
	 Documents	Suitable for photos of timetables or other documents. The camera heightens the contrast between the text and background.
	 Multi Focus Shot	The camera takes eight photos, varying the focus distance with each shot. <ul style="list-style-type: none"> For information on taking photos using this feature, see "[Focus Bracketing]: Varying Focus Distance over a Series of Shots" (P. 69), starting from Step 2.

- To maximize the benefits of the scene modes, some of the shooting function settings are disabled.
- Some time may be needed to record pictures taken using [e-Portrait]. In addition, when the image quality mode is [RAW], the image is recorded in RAW+JPEG.
- Movies cannot be recorded using [e-Portrait], [Handheld Starlight], [Panorama], or [Backlight HDR].
- [Handheld Starlight] pictures taken with [RAW] selected for image quality will be recorded in RAW+JPEG format, with the first frame recorded as a RAW image and the final composite as a JPEG image.
- [Backlight HDR] records HDR-processed images in JPEG format. When the image quality mode is set to [RAW], the image is recorded in RAW+JPEG.
- In [Panning],  is displayed during panning detection, and  is displayed when nothing is detected.
- When using a lens with an image stabilizer switch in [Panning], turn the image stabilizer switch off.

Sufficient panning effects may not be obtained in bright conditions. Use a commercially available ND filter to obtain effects more easily.

Shooting in advanced photo mode

(**AP** mode)

Use for quick access to advanced shooting settings.

- 1 Rotate the mode dial to **AP**.

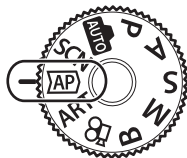

- 2 Use $\triangleleft \triangleright$ to highlight an AP mode.
 - Some modes offer additional options that can be accessed using ∇ .





- 3 Press the **OK** button to select the highlighted mode.
 - Press the **DISP** button to choose a different mode. If additional options are displayed, press \triangle .



- In some modes, the front dial can be used for exposure compensation (P. 81) and the rear dial for program shift (P. 36).
- Touch controls can also be used.

AP Mode Options

AP mode	Description	
Live Composite	Record light trails from stars and other objects while keeping exposure constant overall.	61
Live Time	Choose for photos of fireworks and night scenery. Make long time exposures at selected shutter speeds.	62
Multiple Exposure	Combine two different images on top of one another.	63
HDR	Capture details in both highlights and shadows.	64
Silent [♥]	Disable camera sounds and lights in situations in which they may be unwelcome.	65
Panorama	Take a series of shots that are joined together to create a wide-angle photo. Choose from two angles of view: a wider angle than normal shots (STO), or an even wider angle (WIDE).	66
Keystone Compensation	Correct the effects of perspective in photos of buildings or landscapes.	67
AE Bracketing	Each time the shutter button is pressed, the camera takes a series of photos, varying exposure with each shot.	68

AP mode	Description	
 Focus Bracketing	Each time the shutter button is pressed, the camera takes a series of eight photos, varying the focus distance with each shot.	69

[Live Composite]: Live Composite Photography

Create photos that record light trails from stars and other objects without changing the brightness of the background; during shooting, the changing results can be viewed in the monitor. You can adjust white balance or picture mode and other settings not available with the **SCN** mode “Light Trails” option.



- 1** Highlight [Live Composite] on the AP-mode-selection screen (P. 60) and press the  button.
- 2** Press the shutter button halfway down to focus.
 - To reduce blur caused by camera shake, fix the camera securely to a tripod and use a remote shutter release controlled via OI.Share (P. 161).
 - If the focus indicator blinks, the camera is not in focus.
- 3** Press the shutter button all the way down to shoot.
 - The camera configures the proper settings automatically and starts shooting.
 - After pressing the shutter button, there is a time lag until shooting starts.
 - The composite image will be displayed at regular intervals.
- 4** Press the shutter button again to stop shooting.
 - View the changing result in the monitor and press the shutter button to end shooting once the desired result is achieved.
 - The recording length in one shooting is up to 3 hours.



- Advanced settings can be accessed via live composite photography (dark and light field composite) in **B** mode (P. 44).





[Live Time]: Live Time Photography

You can make long exposures without having to keep the shutter button pressed. The changing result can be viewed in the monitor during shooting.

- 1 Highlight [Live Time] on the AP-mode-selection screen (P. 60).
 - 2 Press ∇ , use $\triangleleft \triangleright$ to choose the maximum exposure time, and press the \odot button.
 - The display refresh rate may change automatically depending on the maximum exposure time selected.
 - The shorter the maximum exposure time, the faster the display refresh rate.
- 
- 3 Press the shutter button halfway down to focus.
 - To reduce blur caused by camera shake, fix the camera securely to a tripod and use a remote shutter release controlled via OI.Share (P. 161).
 - If the focus indicator blinks, the camera is not in focus.
 - 4 Press the shutter button all the way down to start live time photography.
 - The camera adjusts settings automatically and begins shooting.
 - The changing result can be viewed in the monitor.
 - 5 Press the shutter button again to stop shooting.
 - View the changing result in the monitor and press the shutter button to end shooting once the desired result is achieved.
 - Shooting ends automatically when the selected exposure time is reached.
- 
- The long exposure (bulb/time) options in **B** mode offer more advanced settings (P. 42).

[Multiple Exposure]: Shooting Multiple Exposures

Combine two different images on top of one another.

- 1 Highlight [Multiple Exposure] on the AP-mode-selection screen (P. 60) and press the  button.
- 2 Press the shutter button halfway down to focus.
 - If the focus indicator blinks, the camera is not in focus.
- 3 Press the shutter button all the way down for the first shot.
 -  is displayed in green if shooting starts.
 - The image is shown superimposed on the monitor.
 - Press  to delete the last shot.
- 4 Take the second shot.
 - Use the first image as a guide to compose the second shot.
 - The camera will not go to sleep while multiple exposure is in effect.
 - Performing any of the following actions automatically deletes the second shot:
 - The camera is turned off; the  button is pressed; the **MENU** button is pressed; the  button is pressed; the mode dial is rotated; the battery power runs out; or any cable is connected to the camera



- For more information on creating image overlays:  “Combining Pictures (Image Overlay)” (P. 141)



- Advanced settings can be used when you select [Multiple Exposure] in the **P/A/S/M** mode while the profile control switch is not in the COLOR/MONO position.
 -  “Recording multiple exposures in a single image (Multiple Exposure)” (P. 131)

[HDR]: Taking Composite Photos with HDR

Capture details in both highlights and shadows. The camera varies exposure over a series of four shots and combines them into a single image.

- 1 Highlight [HDR] on the AP-mode-selection screen (P. 60).
- 2 Press ∇ , use $\triangleleft \triangleright$ to choose [HDR1] or [HDR2], and press the \odot button.



HDR1	Four shots are taken, each with a different exposure, and the shots are combined into one HDR image inside the camera. HDR2 provides a more impressive image than HDR1. ISO sensitivity is fixed to 200.
HDR2	





- 3 Press the shutter button halfway down to focus.
 - If the focus indicator blinks, the camera is not in focus.
- 4 Press the shutter button all the way down to start HDR photography.
 - The camera automatically takes four shots when the shutter button is pressed.
 - Noise may be more noticeable in photos taken in conditions associated with slow shutter speeds.
 - For best results, secure the camera by, for example, mounting it on a tripod.
 - The image displayed on the monitor during shooting differs from the final HDR picture.
 - The HDR-processed image will be saved as a JPEG file. When the image quality mode is set to [RAW], the image is recorded in RAW+JPEG.
 - The picture mode is fixed to [Natural] and the color space is fixed to [sRGB].

[Silent [♥]] Mode

Disable camera sounds and lights in situations in which they may be unwelcome.

- 1 Highlight [Silent [♥]] on the AP-mode-selection screen (P. 60) and press the  button.
- 2 Press the shutter button halfway down to focus.
 - If the focus indicator blinks, the camera is not in focus.
- 3 Press the shutter button all the way down to shoot.
 - When the shutter is released, the monitor screen will go dark for a moment. No shutter sound will be emitted.
 - The desired results may not be achieved under flickering light sources such as fluorescent or LED lamps or if the subject moves abruptly during shooting.
 - When [Silent [♥]] is selected in the **SCN** or **AP** mode, the following measures are undertaken to reduce the sound and light produced by the camera.
 - Electronic shutter: Enabled
 - ): Off
 - AF Illuminator: Off
 - Flash mode: Off
 - Noise reduction is not available when [Silent [♥]] is selected in the **SCN** or **AP** mode.
 - Note that due to the electronic shutter, the subject may appear to be distorted in photographs if camera moves quickly during shooting or when shooting fast-moving subjects.





- Press  for sequential/self-timer photography (P. 86).
- Advanced settings can be used when you select Silent [♥] photography (P. 88) in the **P/A/S/M/ART** mode.  "Setting anti-shock/silent shooting (Anti-Shock[♦]/Silent[♥])" (P. 135)

Shooting a Panorama

Pan the camera following an on-screen guide to create a single wide-angle (panorama) photo.

1 Highlight [Panorama] on the AP-mode-selection screen (P. 60).

2 Press ∇ , then use $\triangleleft \triangleright$ to highlight the desired panorama type and press the \odot button.

	Take panorama photos with a wider angle of view than other shots.
	Take panorama photos with a wider angle of view than  .



3 Highlight a pan direction using $\triangle \nabla \triangleleft \triangleright$ and press the \odot button.

- You can also select the pan direction using the front and rear dials.



4 Press the shutter button halfway to focus.

5 Press the shutter button the rest of the way down to start shooting, and then pan the camera slowly in the direction indicated by the arrow in the display.

- The arrow in the display moves as the camera is panned.
- To cancel shooting and return to Step 3, press the **MENU** button.



6 When the arrow in the display reaches the end of the progress bar, shooting will end and the camera will create a panorama.



- Focus, exposure, and the like are fixed at the values in effect at the start of shooting.
- Before the arrow reaches the end of the progress bar, you can press the \odot button or press the shutter button again to end shooting and record a panorama from the data recorded to the current point.
- Shooting may be cancelled and an error displayed if:
 - the camera is panned too slowly or too quickly/the camera is panned diagonally/
 - the camera is panned in the opposite direction to the arrow in the display/the lens is zoomed in or out/panning does not start within a set period
- Panorama photography may be unavailable with some lenses.

[Keystone Compensation]

Keystone distortion due to the influence of lens focal length and proximity to the subject can be corrected, or enhanced to exaggerate the effects of perspective. Keystone compensation can be previewed in the monitor during shooting. The corrected image is created from a smaller crop, slightly increasing the effective zoom ratio.

1 Highlight [Keystone Compensation] on the AP-mode-selection screen (P. 60) and press the **OK** button.

2 Frame the shot and adjust keystone compensation while viewing your subject in the display.

- Use the front and rear dials to choose the compensation amount.
- Use $\Delta \nabla \langle \rangle$ to choose the area to be recorded. Depending on the compensation amount, you may be unable to choose the area recorded.
- Press and hold the **OK** button to cancel any changes.
- To adjust exposure compensation and other shooting options while keystone compensation is in effect, press the **INFO** button to view a display other than keystone compensation adjustment. To resume keystone compensation, press the **INFO** button until keystone compensation adjustment is displayed.



3 Press the shutter button halfway down to focus.

- If the focus indicator blinks, the camera is not in focus.

4 Press the shutter button all the way down to shoot.

- As the compensation amount increases:
 - The image will become coarser
 - The zoom ratio of the crop will increase
 - It will no longer be possible to reposition the crop in both the vertical and horizontal displays
- Photos are recorded in RAW+JPEG format when [RAW] is selected for image quality.
- The desired results may not be obtained with converter lenses.
- Depending on the amount of correction, some AF targets may be outside the display area. An icon (\uparrow , \downarrow , \leftarrow or \rightarrow) is displayed when the camera focuses on an AF target outside the display area.
- If a focus distance is selected for [Image Stabilizer], the correction will be adjusted for the selected focus distance. Except when using a Micro Four Thirds or Four Thirds lens, choose a focal length using the [Image Stabilizer] option (P. 96).

[AE Bracketing]: Varying Exposure over a Series of Shots

Take a series of photos, varying the exposure with each shot.

- 1 Highlight [AE Bracketing] on the AP-mode-selection screen (P. 60).
- 2 Press ∇ , use $\triangleleft \triangleright$ to choose the number of shots, and press the OK button.

3f	Take 3 shots, the first at optimal exposure (± 0.0 EV), the second at -1.0 EV, and the third at $+1.0$ EV.
5f	Take 5 shots, the first at optimal exposure (± 0.0 EV), the second at -1.3 EV, the third at -0.7 EV, the fourth at $+0.7$ EV, and the fifth at $+1.3$ EV.

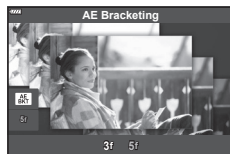



- 3 Press the shutter button halfway down to focus.
 - If the focus indicator blinks, the camera is not in focus.
- 4 Press the shutter button all the way down to shoot.
 - Take the set number of shots.
 - The BKT indicator turns green during bracketing.
 - The camera brackets the value currently selected for exposure compensation.

[Focus Bracketing]: Varying Focus Distance over a Series of Shots

Each time the shutter button is pressed, the camera takes a series of eight photos, varying the focus distance with each shot.

- 1 Highlight [Focus Bracketing] on the AP-mode-selection screen (P. 60).
- 2 Press ∇ , use $\triangleleft \triangleright$ to choose the amount focus distance changes with each shot, and press the OK button.

	The focus distance changes by a small amount with each shot.
	The focus distance changes by a large amount with each shot.



- 3 Press the shutter button halfway down to focus.
 - If the focus indicator blinks, the camera is not in focus.
- 4 Press the shutter button all the way down to shoot.
 - The camera takes eight photos, varying the focus distance with each shot. The camera will take pictures at, and at distances in front of and behind, the focus distance chosen when the shutter button is pressed halfway.
 - The BKT indicator turns green during bracketing.
 - Focus bracketing ends if zoom is adjusted during shooting.
 - Shooting ends when focus reaches ∞ (infinity).
 - Focus bracketing uses the electronic shutter.
 - Focus bracketing is not available with lenses that have mounts conforming to the Four Thirds or some Micro Four Thirds standards.

Using art filters, you can easily have fun with artistic effects.

- 1 Rotate the mode dial to **ART**.

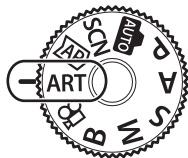

- 2 Use $\triangleleft \triangleright$ to highlight a filter.

- The slider appears on the display when [Pop Art I/II], [Soft Focus], [Pin Hole I/II/III], [Cross Process I/II] or [Instant Film] is highlighted. Use the slider to adjust the degree of the art filter effect (P. 73).



Slider

- 3 Press ∇ , and highlight an effect using $\triangleleft \triangleright$.

- The effects available vary with the selected filter (Soft Focus Effect, Pin Hole Effect, White Edge Effect, Frame Effect, Star Light Effect, Blur Effect, Shade Effect, Color Filter, or Monochrome Color).

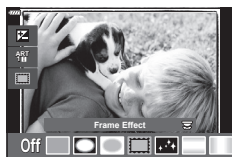

- 4 Press ∇ to adjust exposure compensation.

- The slider will appear on the display.
- Rotate the front dial to adjust exposure compensation.
- Choose positive (“+”) values to make pictures brighter, negative (“-”) values to make pictures darker. Exposure can be adjusted by ± 5.0 EV. During live view, the brightness of the monitor will be adjusted to a maximum of only ± 3.0 EV. If the exposure exceeds ± 3.0 EV, the exposure bar will begin flashing.
- To reset exposure compensation, press and hold the OK button.



Exposure bar

- 5 Press the OK button.

- 6 Shoot.

- Press the M button to choose a different art filter. If effects are displayed, press \triangle . If [Exposure/Brightness] is displayed, press ∇ .



- [Color Filter] (P. 108) and [Monochrome Color] (P. 109) options are available with some art filters.
- After you press the  button in Step 5, the front dial can be used for exposure compensation (P. 81) and the rear dial for program shift (P. 36).
- Touch controls can also be used.

Types of art filters



Pop Art I/II	Creates an image that emphasizes the beauty of color.
Soft Focus	Creates an image that expresses a soft tone atmosphere.
Pale&Light Color I/II	Creates an image that expresses warm light by scattering overall light and slightly overexposing the image.
Light Tone	Creates a high-quality image by softening both shadows and highlights.
Grainy Film I/II	Creates an image that expresses the roughness of black and white images.
Pin Hole I/II/III	Creates an image that looks as if it was taken using an old or toy camera by dimming the image perimeter.
Diorama I/II	Creates a miniature-like image by emphasizing saturation and contrast, and blurring unfocused areas.
Cross Process I/II	Creates an image that expresses a surreal atmosphere. Cross Process II creates an image that emphasizes magenta.
Gentle Sepia	Creates a high-quality image by drawing out shadows and softening the overall image.
Dramatic Tone I/II	Creates an image that emphasizes the difference between brightness and darkness by partially increasing contrast.
Key Line I/II	Creates an image that emphasizes edges and adds an illustrative style.
Watercolor I/II	Creates a soft, bright image by removing dark areas, blending pale colors on a white canvas, and further softening contours.
Vintage I/II/III	Expresses an everyday shot in a nostalgic, vintage tone using printed film discoloration and fading.
Partial Color I/II/III	Impressively expresses a subject by extracting colors you want to emphasize and keeping everything else monotone.
Bleach Bypass I/II	The "bleach bypass" effect, which you may recognize from motion pictures and the like, can be used to great effect in shots of streetscapes or metal objects.
Instant Film	A contemporary take on the skin tones and shadow gradations typical of film.

II and III are altered versions of the original (I).

- To maximize the benefits of the art filters, some of the shooting function settings are disabled.
- If [RAW] is currently selected for image quality (P. 98), image quality will automatically be set to RAW+JPEG. The art filter will be applied to the JPEG copy only.
- Depending on the subject, tone transitions may be ragged, the effect may be less noticeable, or the image may become more "grainy."
- Some effects may not be visible during movie recording.
- Your choice of filters, effects, and movie quality when recording movies may affect playback speed and smoothness.

Adjusting the degree of the art filter effect (Fine-Tuning)

You can adjust the degree of the filter effect for Pop Art, Soft Focus, Pin Hole, Cross Process, and Instant Film before taking pictures.



- 1 Select [Pop Art I/II], [Soft Focus], [Pin Hole I/II/III], [Cross Process I/II], or [Instant Film] on the art-filter-selection screen (P. 70).
 - The slider will appear on the display.
 - Rotate the front dial to fine-tune the art filter.
 - Touch controls can also be used.
 - The effect is visible in the display.
 - To reset the filter effect, press and hold the  button.
- 2 Press the  button.
- 3 Shoot.
 - Press the  button if you want to fine-tune the art filter again.



Slider



Using [Partial Color]

Record only selected hues in color.

- 1 Select [Partial Color I/II/III] in the art filter-selection screen (P. 70).
 - A color ring appears in the display.
- 2 Rotate the front dial to select a color.
 - The effect is visible in the display.
 - Touch controls can also be used.
- 3 Press the  button.
- 4 Shoot.
 - To choose a different color after shooting, press the  button.



Recording movies in photo shooting modes

The  button can be used for movie recording even when the mode dial is not in the  position.



- Be sure that [ REC] is assigned to the  button (P. 112).

1 Press the button to begin recording.

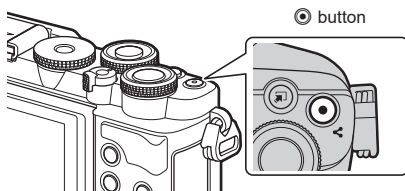
- Movie you are recording will be displayed on the monitor.
- You can change the focus location by tapping the screen while recording.



2 Press the button again to end recording.



- The sound of touch operations and button operations may be recorded.
- CMOS image sensors of the type used in the camera generate a so-called “rolling shutter” effect that can cause distortion in pictures of moving objects. This distortion is a phenomenon that occurs in pictures of fast-moving subjects or if the camera is moved during shooting. It is particularly noticeable in pictures taken at long focal lengths.
- If the size of the movie file being recorded exceeds 4 GB, the file will be split automatically. (Depending on shooting conditions, movies under 4 GB in size may be split into multiple files.)
- When the camera is used continuously for extended periods, the temperature of the image sensor will rise and noise and color splotches may be visible in the display. Should this occur, turn the camera off and wait for it to cool. Noise and color splotches are particularly likely to occur at high ISO sensitivities. If the temperature of the sensor increases further, the camera will turn off automatically.
- The  button cannot be used to record movies in the following instances:
 - While shutter the button is pressed halfway; during bulb, time, composite, sequential or time lapse photography; or when e-portrait, handheld starlight, panorama, or backlight HDR is selected in **SCN** mode or keystone compensation, panorama, live time, multiple exposure, or HDR is selected in **AF** mode
- When recording movies, use an SD card that supports an SD speed class of 10 or higher.
- A UHS-II or UHS-I card with a UHS speed class of 3 or better is required when:
 - a movie resolution of [4K] is selected in the [ ] menu



- Some settings, such as AF mode, can be set separately for movies and photographs.
 -  “Using the Video Menu” (P. 136)

Recording movies in movie mode

When the mode dial is rotated to , movies can be recorded using functions such as the slow-motion mode.

- Adjust aperture and shutter speed to suit your artistic intent.  “Choosing an Exposure Mode ( Mode (Movie Exposure Modes))” (P. 115)

1 Rotate the mode dial to .

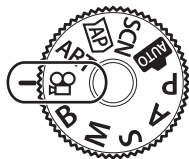





2 Use   to highlight movie mode (P. 76).



3 Press the  button to select the highlighted mode.

- Press the  button to choose a different movie mode.

4 Press the  button to begin recording.

- Be sure that  REC is assigned to the  button (P. 112).
- Press the  button again to end recording.
- The sound level during recording is shown by the recording level meter. The more the meter extends into the red, the higher the recording level.
- The recording level can be adjusted from the  video menu.  [Recording Volume] (P. 136)

Recording level meter







- A beep does not sound when the camera focuses in movie mode.



- You can prevent the camera from recording operating sounds that occur due to camera operations while shooting.  “Silencing Camera Sounds While Shooting Movies” (P. 77)
- Touch controls can also be used.

Movie Mode Options

Movie mode	Description	
 4K	Shoot 4K movies.	—
 Standard	Shoot standard movies.	—
 High-speed	Record slow-motion movies. Sound will not be recorded.	77

- The picture modes available vary with the movie mode.
- When recording movies, use an SD card that supports an SD speed class of 10 or higher.
- Use UHS-II or UHS-I memory card with a UHS Speed Class of 3 when shooting in [4K] or [High-speed] mode.
- Depending on the system, some computers may be unable to play movies recorded at [4K]. See our website for information on the system requirements for viewing 4K movies on a computer.

Recording Slow Motion Movies

Record slow-motion movies. Footage shot at 120 fps plays back at 30 fps; quality is equivalent to [HD].

- 1 Highlight [High-speed] in the movie mode option (P. 76) and press the **OK** button.
- 2 Press the **DISP** button to start shooting.
 - Press the **DISP** button again to end shooting.
 - Focus and exposure are fixed at the start of recording.
 - Recording can continue for up to 20 seconds.
 - Sound will not be recorded.

Silencing Camera Sounds While Shooting Movies

You can prevent the camera from recording operating sounds that occur due to camera operations while shooting.

Tap the silent shooting tab to display the function items. After tapping an item, tap the displayed arrows to select the settings.

- Electronic zoom*, recording volume, aperture, shutter speed, exposure compensation, ISO sensitivity
 - * Only available with power zoom lenses
- The options available vary with the movie exposure modes (P. 115).
- This option is not available in self-portrait mode (P. 78).

Silent shooting tab



Taking Photos in Self-Portrait Mode

Inverting the monitor allows you to take pictures of yourself while you preview the frame.

- 1 If the monitor is open, close it.

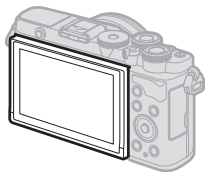

- 2 Open the monitor downward.

- Read "Rotating the Monitor: Cautions" (P. 31) before moving the monitor.

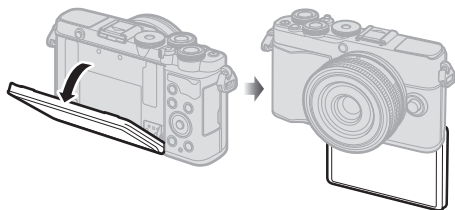

- If a power zoom lens is attached, the camera automatically switches to wide angle.
- The self portrait menu is displayed in the monitor.
- Different icons may be displayed depending on the shooting mode.



	Shutter Touch	When the icon is touched, the shutter is released about 1 second later.
	Movie	When you touch this icon, movie recording will start. To stop recording, press the () icon.
	Playback	Tap to switch to playback mode (P. 127).
	One-Touch e-Portrait	Turning this on makes skin look smooth and translucent.
	One-Touch Custom Self Timer	Shoot 3 frames using the self timer. You can set the number of times the shutter is released and the interval between each release using Custom Self Timer. "Self-Timer Options (Custom Self-timer)" (P. 87)
	Brightness adjustment (Exposure compensation)	Touch [+] or [-] icon to adjust the brightness.

- 3** Frame the shot.
 - Be careful that your fingers or the camera strap do not obstruct the lens.
- 4** Touch  and shoot.
 - You can also shoot by touching the subject displayed in the monitor, or by pressing the shutter button.
 - The shot image will be displayed on the monitor.
- Be careful not to drop the camera when using the touch screen with the camera held in one hand.

Using various settings

Buttons and dials

Frequently used photographic functions can be assigned to the buttons and dials.

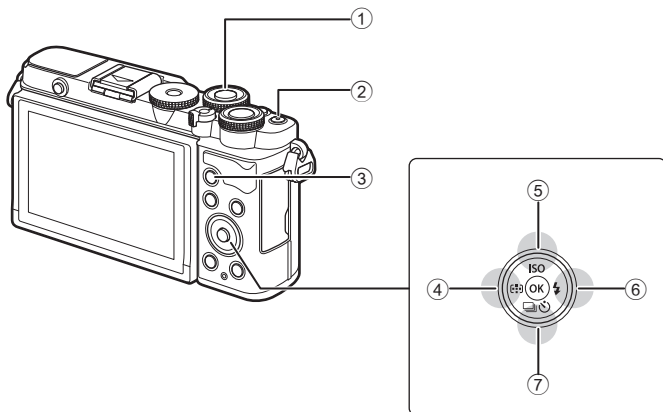

Button/dial	Assigned function	
① Front dial	Exposure compensation*	81
② button	Movie recording**	74
③ AEL/AFL button	AEL/AFL**	112, 151
④ button (\triangleleft)	AF Area/AF target position	81, 82
⑤ ISO button (Δ)	ISO sensitivity	83
⑥ button (\triangleright)	Flash modes	84
⑦ button (∇)	Sequential/self-timer shooting	86-88

* You can choose the functions performed by the front and rear dials. [Dial Function] (P. 145)

** Buttons can be assigned different roles. "Assigning functions to buttons (Button Function)" (P. 112)

The exposure selected automatically by the camera can be altered to suit your artistic intent. Choose positive values to make pictures brighter, negative values to make them darker. Exposure compensation can be adjusted by up to ± 5.0 EV.



- 1 Rotate the front dial to adjust exposure compensation.

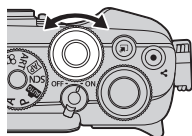

- Exposure compensation is not available in **Auto**, **M**, **B**, or **SCN** mode or when Live Time or panorama is selected in **AP** mode.
- The live view shows the effects of values not exceeding ± 3.0 EV. If the exposure exceeds ± 3.0 EV, the exposure bar will begin flashing.
- Movies can be corrected in a range up to ± 3.0 EV.



Selecting the AF target mode

(AF Area)

The frame showing the location of the focus point is referred to as the “AF target”. You can change the size of the AF target. You can also select Face priority AF (P. 82).

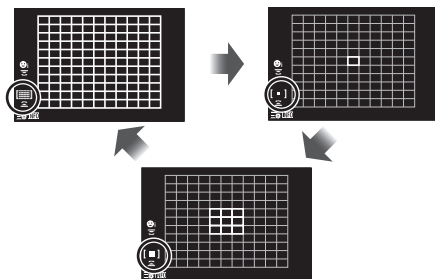
- 1 Press the **[:]** (< >) button to display the AF target.
- 2 Select **[[]]** (Single Target) or **[[]]** (9-Target Group) using the front dial.



 All Targets	The camera automatically chooses from the full set of focus targets.
 Single Target	You can choose a single AF target.
 9-Target Group	The camera automatically chooses from the targets in the selected nine-target group.

- The single target mode is automatically applied in movie shooting if the group target mode is set.

Setting the location of the focus (AF target position)

You can position the target over your subject.

- 1 Press the **[:::]** (**<**) button to display the AF target.
 - If **[]** (All Targets) is selected, select **[I ■]** (Single Target) or **[I ■■]** (9-Target Group) using the front dial.
- 2 Use **△ ▽ < ▷** to choose a focus area.
 - The size and number of the AF targets changes with the aspect ratio (P. 97) and the option selected for [Digital Tele-converter] (P. 130).



- Touch controls can also be used.

Face priority AF/Eye priority AF

The camera automatically detects and focuses on the faces or eyes of portrait subjects. When digital ESP metering is used, exposure will be weighted according to the value metered for the face.

- 1 Press the **[:::]** (**<**) button to display the AF target.
- 2 Select an option using the rear dial.



	Face Priority On	The camera detects and focuses on faces.
	Face Priority Off	Face priority AF off.
	Face & Eye Priority On	The camera detects faces and focuses on the eye closest to the camera.

- 3 Point the camera at your subject.
 - If a face is detected, it will be indicated by a white frame.
- 4 Press the shutter button halfway to focus.
 - When the camera focuses on the face in the white frame, the frame will turn green.
 - If the camera is able to detect the subject's eyes, it will display a green frame over the selected eye (eye priority AF).
- 5 Press the shutter button the rest of the way down to shoot.

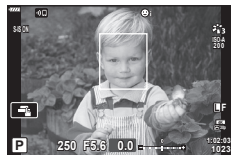

- Depending on the subject and the art filter setting, the camera may not be able to correctly detect the face.
- When set to **[]** (Digital ESP metering) (P. 93), metering is performed with priority given to faces.



- Face priority is also available in [MF] (P. 92). Faces detected by the camera are indicated by white frames.

Changing ISO sensitivity (ISO)

Select a value according to subject brightness. Higher values let you photograph darker scenes but also increase image “noise” (mottling). Select [AUTO] to let the camera adjust sensitivity according to lighting conditions.

- 1 Press the ISO (Δ) button.
- 2 Use $\triangleleft \triangleright$ to select an option.

AUTO	Sensitivity is adjusted automatically according to shooting conditions. Use [ISO-Auto Set] (P. 147) in \star Custom Menu D1 to choose the maximum sensitivity selected by the camera and the shutter speed at which auto sensitivity control takes effect.
LOW, 200–25600	Choose a value for ISO sensitivity. ISO 200 offers a good balance between noise and dynamic range.

The flash can be used for flash photography in a variety of shooting conditions.

- 1 Press the flash pop-up button to raise the flash.

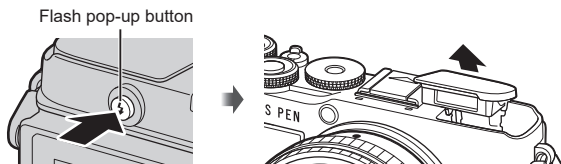

- 2 Press the \downarrow (▷) button.

- 3 Select an item using ◀▷, and then press the (OK) button.

- The options available and the order in which they are displayed vary depending on the shooting mode. "Flash modes that can be set by shooting mode" (P. 85)

\downarrow Fill In	The flash fires. • Shutter speed can be set to values between that selected for [\downarrow Slow Limit] (P. 148) and [\downarrow X-Sync.] (P. 148) in Custom Menu E .
\downarrow Redeye	The flash fires so that the red-eye phenomenon is reduced.
Flash Off	The flash does not fire.
\downarrow Red-E Slow Slow synchronization (1st curtain/Red-eye reduction flash)	The slow synchronization is combined with the red-eye reduction flash.
\downarrow Slow Slow synchronization (1st curtain)	The flash fires with slow shutter speeds to brighten dimly-lit backgrounds.
\downarrow Slow2 Slow synchronization (2nd curtain)	The flash fires immediately before the shutter closes to create trails of light behind moving light sources.
\downarrow FULL, \downarrow 1/4 etc. Manual Value	For users who prefer manual operation. Press the INFO button and use Δ ∇ to adjust flash output.

- In [\downarrow Redeye], after the pre-flashes, it takes about 1 second before the shutter is released. Do not move the camera until shooting is complete.
- [\downarrow Redeye] may not work effectively under some shooting conditions.
- When the flash fires, the shutter speed is set to 1/250 seconds or slower. When shooting a subject against a bright background with the flash, the background may be overexposed.
- The flash sync speed for the silent mode (P. 88) is 1/20 seconds or less.

Optional Flash Units

When using optional flash units, be sure the built-in flash has been securely restored to its housing.

Flash modes that can be set by shooting mode

Shooting mode	Monitor	Flash mode	Flash timing	Shutter speed limit
P/A		Fill In	1st curtain	30 sec. – 1/250 sec.**
		Redeye		
		Flash Off	—	—
		Red-Eye Slow Slow synchronization (1st curtain/ Red-eye reduction flash)	1st curtain	60 sec. – 1/250 sec.**
		Slow Slow synchronization (1st curtain)		
		Slow2 Slow synchronization (2nd curtain)	2nd curtain	
	Fill In	1st curtain	60 sec. – 1/250 sec.**	
	Redeye			
S/M		Flash Off	—	—
		Slow2 Slow synchronization (2nd curtain)	2nd curtain	60 sec. – 1/250 sec.**
		Fill In	1st curtain	—
		Redeye		
B*		Flash Off	—	—
		Slow2 Slow synchronization (2nd curtain)	2nd curtain	—
		Fill In	1st curtain	—
		Redeye		

• Only and can be set in mode.

* 2nd-curtain sync is not available when [LIVE COMP] is selected (P. 44).

** For the silent mode, the shutter speed is 1/20 seconds.

Minimum range





The lens may cast shadows over objects close to the camera, causing vignetting, or the flash may be too bright even at minimum output.













Lens	Approximate distance at which vignetting occurs
17mm f1.8	0.25 m
25mm f1.8	0.25 m
45mm f1.8	0.5 m
ED 14-42mm f3.5-5.6 EZ	1 m
ED 40-150mm f4.0-5.6	0.9 m

• External flash units can be used to prevent vignetting. To prevent photographs from being overexposed, select **A** or **M** mode, and choose a high aperture value or reduce ISO sensitivity.





Performing the sequential/self-timer shooting

Adjust settings for burst or self-timer photography. Choose an option according to your subject. Other options, including anti-shock and silent modes, are also available.

- 1 Press the   button.
- 2 Use   to select an option.
 - Custom self-timer options can be viewed by pressing the **INFO** button (P. 87).

 Single	Single-frame advance. The camera takes one photo each time the shutter button is pressed all the way down.
 Sequential High	The camera takes photos at up to about 8.7 fps while the shutter button is held all the way down. Focus, exposure, and white balance are locked at the values for the first shot in each series.
 Sequential Low	The camera takes photos at up to about 5 fps while the shutter button is held all the way down. Focus and exposure conform to the options selected for  AF Mode] (P. 92) and [AEL/AFL] (P. 151). If [C-AF] or [C-AF+TR] is selected for  AF Mode], the camera will focus before each shot.
  12 sec	The shutter is released 12 s after the shutter button is pressed all the way down. The self-timer lamp will light for about 10 s and then start to flash about 2 s before the shutter is released. The camera focuses when the shutter button is pressed halfway.
  2 sec	When the shutter button is pressed all the way down, the self-timer lamp will start to flash and a photo will be taken after about 2 seconds. The camera focuses when the shutter button is pressed halfway.
 Custom Self-Timer	Adjust self-timer settings, including the self-timer delay and the number of shots taken when the timer expires (P. 87).
 (sample icon) Anti-Shock [⬆]	Reduce the slight blur caused by shutter motion. Available in single-frame, sequential low, and custom self-timer modes (P. 88).
 (sample icon) Silent [♥]	Take pictures with the electronic shutter. Use for shutter speeds faster than 1/4000 s or in settings where the sound of the shutter would be unwelcome. Available in single-frame, sequential low, sequential high, and Custom self-timer modes. In  mode, focus, exposure, and white balance are locked at the values for the first shot in each series. The flash sync speed drops to 1/20 s (P. 88).

- 3 Press the  button.











- Fix the camera securely on a tripod for self-timer shooting.
- If you stand in front of the camera to press the shutter button when using the self-timer, the picture may be out of focus.
- When you are using ,  or , live view is displayed. In  or , the display shows the last photograph taken during the sequential shooting.
- The speed of sequential shooting varies depending on the lens you are using and the focus of the zoom lens.
- During sequential shooting, if the battery level icon blinks due to low battery, the camera stops shooting and starts saving the pictures you have taken on the card. The camera may not save all of the pictures depending on how much battery power remains.



- To cancel the activated self-timer, press .

Self-Timer Options (Custom Self-timer)

Adjust self-timer settings, including the shutter release delay and the number of shots taken when the timer expires.

- 1 Press the   () button.
- 2 Highlight  (custom self-timer) using  , and then press the **INFO** button.
- 3 Highlight items using  , and then use   to choose an option.





Number of Frames	Choose the number of shots taken when the timer expires.
 Timer	Choose how long the camera waits to begin shooting after the shutter button is pressed all the way down.
Interval Length	If the number of shots is 2 or more, choose the interval between the shots taken when the timer expires.

Shooting without the vibration caused by shutter button operations (Anti-Shock [♦])

Reduce the slight blur caused by shutter motion.

Use this option when even slight camera motion can cause blur, for example during macro or telephoto photography.



- The delay between the shutter button being pressed all the way down and the start of shooting can be selected using [Anti-Shock [♦]/Silent [♥]] > [Anti-Shock [♦]] in  Shooting Menu 2 (P. 135).

- 1 Press the  (▽) button.
- 2 Select one of the items marked ♦ using <◁▷>, and then press the  button.
- 3 Take pictures.
 - When the set time has elapsed, the shutter is released and the picture is taken.

The Electronic Shutter (Silent [♥])

Take pictures using the electronic shutter. Use for shutter speeds faster than 1/4000 s or in settings where the sound of the shutter would be unwelcome. The electronic shutter can be used in single-frame mode and custom self-timer modes and for frame rates as high as about 15 fps in sequential shooting modes. This setting is only available in **P/A/S/M/ART** modes.

- The flash sync speed is 1/20 s.
- The delay between the shutter button being pressed all the way down and the shutter being released can be selected using [Anti-Shock [♦]/Silent [♥]] > [Silent [♥]] in  Shooting Menu 2 (P. 135).
- In [Silent [♥]] mode, [■], [AF Illuminator], and [Flash Mode] are set to [Not Allow] by default. You can enable each operation in [Silent[♥]Mode Settings].

- 1 Press the  (▽) button.
- 2 Highlight one of the options marked with ♥ using <◁▷>.
- 3 Press the  button.
- 4 Take pictures.
 - When the shutter is released, the monitor screen will go dark for a moment. No shutter sound will be emitted.
 - The desired results may not be achieved under flickering light sources such as fluorescent or LED lamps or if the subject moves abruptly during shooting.
 - Note that due to the electronic shutter, the subject may appear to be distorted in photographs if camera moves quickly during shooting or when shooting fast-moving subjects.

Calling shooting options

■ LV super control panel

The LV super control panel lists shooting settings and their current values.

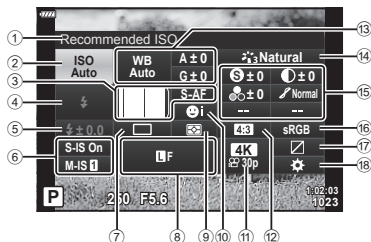

■ Available settings

①	Currently selected option	⑮	Sharpness S	P. 106
②	ISO sensitivity		Contrast !	P. 106
③	📷 AF mode		Saturation ⦿	P. 106
	AF target		Gradation ↗	P. 108
④	Flash mode		Color filter F	P. 108
⑤	Flash intensity control		Monochrome color !	P. 109
⑥	Image stabilizer		Effect E	P. 110
⑦	Sequential shooting/Self-timer		Color 🔄 *1	P. 73
⑧	📷 ←		Color / Vivid 🌈 *2	P. 105
⑨	Metering mode		Effect*3	P. 70
⑩	Face priority		Film Grain Effect*4	P. 107
⑪	📷 ←		Shading*4*5	P. 48. P. 52
⑫	Aspect ratio		Fine-Tune*3	P. 73
⑬	White balance		Color / Vivid 🌈 *5	P. 52
	White balance compensation		ColorFilter/Level 🌈 *4	P. 48
⑭	Picture mode	⑯	Color space	P. 110
		⑰	Highlight & shadow control	P. 111
		⑱	Button function assignment	P. 112

*1 Displayed when Partial Color is selected.

*2 Displayed when Color Creator is selected.

*3 Displayed when Art Filter is selected.

*4 Displayed when Mono Profile is selected for the picture mode.

*5 Displayed when Color Profile is selected for the picture mode.

■ Using the LV Super Control Panel

- 1 Press the **OK** button.
 - The LV super control panel will be displayed. When the mode dial is rotated to **P**, the LV control (P. 91) is displayed.
 - The last setting used will be highlighted.
- 2 Highlight an item using **Δ** **∇** **◀** **▶**, and then press the **OK** button.
 - You can also highlight items by tapping them on the display.
- 3 Use **◀** **▶** to highlight an option, and then press the **OK** button.

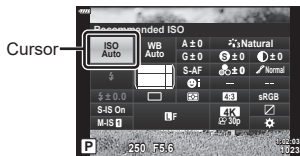

Additional Options

Pressing the **OK** button in Step 2 displays options for the highlighted setting. In some cases, additional options can be viewed by pressing the **INFO** button.

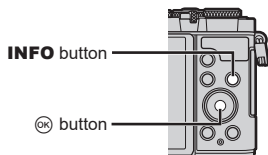

[Image Stabilizer]

- Touch controls can be used in place of the **OK** button. Lightly tap the desired setting twice to display options.

■ LV control

You can use LV control to select the shooting function while checking the effect on the screen.

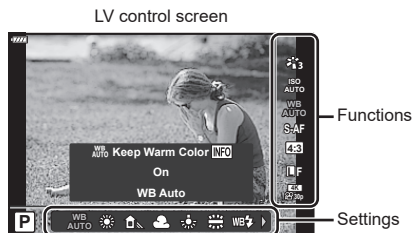

■ Available settings

Picture mode	P. 103	P. 98
ISO sensitivity	P. 83	P. 99
White balance	P. 94	Movie (exposure) mode*2	P. 115
AF mode	P. 92	Scene mode*3	P. 56
Aspect ratio*1	P. 97	Art filter mode*4	P. 70

*1 Not available in movie mode.

*2 Available in movie mode.

*3 Available in **SCN** mode.

*4 Available in **ART** mode.

■ Using the LV control

1 Press **OK** to display the LV control.

- To display the LV control when the mode dial is rotated to a position other than , choose the control in [Control Settings] (P. 146).
- To hide the LV control, press **OK** again.

2 Use **Δ**/**∇** to highlight the desired function and **◀**/**▶** to highlight a setting, and then press the **OK** button.

- You can use the front and rear dials to select a setting.
- The selected settings take effect automatically if no operations are performed for about 8 seconds.

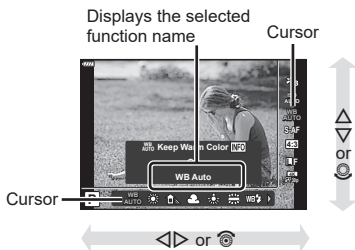

- Some items are not available in some shooting modes.



- For the default settings of each option, refer to "Defaults" (P. 181).

You can select a focusing method (focus mode).

- 1 Press the **OK** button to display the LV super control panel.
- 2 Use **Δ ▽ ◀ ▶** to highlight AF Mode, and then press the **OK** button.

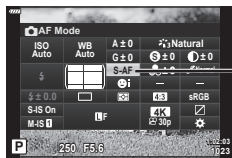



AF Mode

- 3 Highlight an option using **◀ ▶**, and then press the **OK** button.

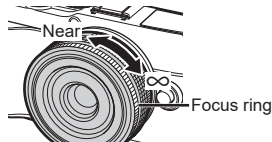
S-AF (Single AF)	The camera focuses once when the shutter button is pressed halfway. When the focus is locked, a beep sounds, and the AF confirmation mark and the AF target mark light up. This mode is suitable for taking pictures of still subjects or subjects with limited movement.
C-AF (Continuous AF)	The camera repeats focusing while the shutter button remains pressed halfway. When the subject is in focus, the AF confirmation mark lights up on the monitor and the beep sounds when the focus is locked at the first time. Even if the subject moves or you change the composition of the picture, the camera continues trying to focus.
MF (Manual focus)	This function allows you to manually focus on any position by operating the focus ring on the lens.
S-AF+MF (Simultaneous use of S-AF mode and MF mode)	After pressing the shutter button halfway to focus in [S-AF] mode, you can turn the focus ring while you keep pressing the shutter button halfway to fine-adjust focus manually.
C-AF+TR (AF tracking)	Press the shutter button halfway to focus; the camera then tracks and maintains focus on the current subject while the shutter button is held in this position. <ul style="list-style-type: none"> • The AF target is displayed in red if the camera can no longer track the subject. Release the shutter button and then frame the subject again and press the shutter button halfway.









- The camera may be unable to focus if the subject is poorly lit, obscured by mist or smoke, or lacks contrast.
- AF mode is unavailable when a Four Thirds system lens is used.
- AF mode is unavailable when the lens MF focus clutch is set to MF.
- If [MF], [C-AF], or [C-AF+TR] is selected in **P**, **A**, **S**, **M**, **B**,  or **ART** mode, the shutter can be released even when the camera is not focus.
- If [C-AF] or [C-AF+TR] is selected, keep the shutter button pressed halfway to let the camera focus on the subject for a little while, and then press the shutter button all the way down to shoot.
- If you operate the zoom during sequential shooting when [C-AF] or [C-AF+TR] is selected, the focus may move off the subject.
- If shooting a fast-moving person in sequential shooting mode when [C-AF] is selected, it is recommended that you select  Face Priority Off (P. 82).
- If shooting a fast-moving subject in sequential shooting mode when [C-AF+TR] is selected, the focus may move off the subject.



- The focus method can be chosen in the  custom menu.  “AEL/AFL” (P. 151)







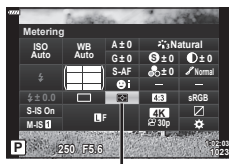

Choosing how the camera measures brightness (Metering)

You can choose how the camera meters subject brightness.

- 1 Press the  button to display the LV super control panel.
- 2 Use    to select [Metering], and then press the  button.
- 3 Highlight an option using , and then press the  button.



Metering

	Digital ESP metering	Meters exposure in 324 areas of the frame and optimizes exposure for the current scene or portrait subject (if an option other than [OFF] is selected for  Face Priority)). This mode is recommended for general use.
	Center weighted averaging metering	Provides the average metering between the subject and the background lighting, placing more weight on the subject at the center. 
	Spot metering	Meters a small area (about 2% of the frame) with the camera pointed at the object you wish to meter. Exposure will be adjusted according to the brightness at the metered point. 
	Spot metering (highlight)	Increases spot metering exposure. Ensures bright subjects appear bright.
	Spot metering (shadow)	Lowers spot metering exposure. Ensures dark subjects appear dark.

Adjusting color (WB (white balance))

White balance (WB) ensures that white objects in images recorded by the camera appear white. [AUTO] is suitable in most circumstances, but other values can be selected according to the light source when [AUTO] fails to produce the desired results or you wish to introduce a deliberate color cast into your images.

- 1 Press the **OK** button to display the LV super control panel.
- 2 Use **Δ ▽ ◀ ▶** to highlight White Balance, and then press the **OK** button.

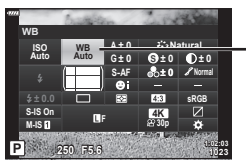



White Balance





- 3 Highlight an option using **◀ ▶**, and then press the **OK** button.
 - One-touch white balance and custom white balance options can be viewed by pressing the **INFO** button.

WB mode		Color temperature	Light conditions
Auto white balance	AUTO	—	Most normal scenes (scenes containing objects that are white or close to white) <ul style="list-style-type: none"> • This mode is recommended in most situations. • You can choose the white balance used under incandescent lighting (P. 148).
Preset white balance		5300 K	For shooting outdoors on a clear day, or to capture the reds in a sunset or the colors in a fireworks display
		7500 K	For shooting outdoors in the shadows on a clear day
		6000 K	For shooting outdoors on a cloudy day
		3000 K	For shooting under a tungsten light
		4000 K	For shooting under a fluorescent light
		5500 K	For flash shooting
One-touch white balance		Color temperature set by one-touch WB	Situations in which you want to set white balance for a specific subject <ul style="list-style-type: none"> • Color temperature is set to a value metered from a white object under the lighting what will be used in the final photograph (P. 95).
Custom white balance	CWB	2000 K–14000 K	Situations in which you can identify the appropriate color temperature <ul style="list-style-type: none"> • Choose a color temperature.

■ One-touch white balance





Measure white balance by framing a piece of paper or other white object under the lighting that will be used in the final photograph. Use this option to fine-tune white balance when you find it hard to obtain the desired results with white balance compensation or preset white balance options such as  (sunlight) or  (overcast).

The camera stores the metered value for quick recall as required.

- 1 Select [, , , or ] (one-touch white balance 1, 2, 3, or 4), and then press the **INFO** button.
- 2 Photograph a piece of colorless (white or gray) paper.
 - Frame the paper so that it fills the display and no shadows fall it.
 - The one-touch white balance screen appears.
- 3 Select [Yes], and then press the  button.
 - The new value is saved as a preset white balance option.
 - The new value is stored until one-touch white balance is measured again. Turning the power off does not erase the data.

■ ^{WB}_{AUTO} Keep Warm Color

Choose how the camera adjusts white balance for pictures taken using auto white balance under incandescent lighting.

- 1 After selecting [AUTO], press the **INFO** button.
 - [^{WB}_{AUTO} Keep Warm Color] options will be displayed.
- 2 Highlight an option using , , , or , and then press the  button.

Off	The camera suppresses the warm tones produced by incandescent lighting.
On	The camera preserves the warm tones produced by incandescent lighting.

Making fine adjustments to white balance (WB Compensation)

You can set and finely adjust the compensation values for both auto white balance and preset white balance.

Before proceeding, choose a white balance option to which to make fine adjustments.

☞ “Adjusting color (WB (white balance))” (P. 94)

- 1 Press the **OK** button to display the LV super control panel.
- 2 Highlight white balance compensation using $\Delta \nabla \langle \rangle$, and then press the **OK** button.
- 3 Use $\langle \rangle$ to choose an axis.
- 4 Choose a value using $\Delta \nabla$, and then press the **OK** button.

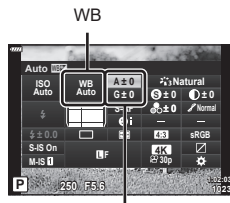

White balance compensation

A	A (amber–blue) axis	Positive values add a red cast, negative values a blue cast.
G	G (green–magenta) axis	Positive values add a green cast, negative values a magenta cast.

- Selecting [Reset] (basic) in Shooting Menu 1 does not reset the values selected.

Reducing camera shake (Image Stabilizer)

You can reduce the amount of camera shake that can occur when shooting in low light situations or shooting with high magnification.

The image stabilizer starts when you press the shutter button halfway.

- 1 Press the **OK** button to display the LV super control panel.
- 2 Use $\Delta \nabla \langle \rangle$ to select [Image Stabilizer], and then press the **OK** button.
- 3 Highlight an option using $\langle \rangle$, and then press the **OK** button.

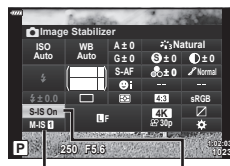

Image Stabilizer

Image Stabilizer

Still picture (S-IS)	S-IS Off	Image stabilizer is off.
	S-IS On	The camera detects the panning direction and applies the appropriate image stabilization.
Movie (M-IS)	M-IS Off	Image stabilizer is off.
	M-IS 1	The camera uses both sensor shift and electronic correction.
	M-IS 2	The camera uses sensor shift correction only. Electronic correction is not used.

- The edges of the frame are cropped out when [M-IS 1] is selected, reducing the area recorded.
- The image stabilizer cannot correct excessive camera shake or camera shake that occurs when the shutter speed is set to the slowest speed. In these cases, it is recommended that you use a tripod.
- When using a tripod, set [Image Stabilizer] to [S-IS Off]/[M-IS Off].
- When using a lens with an image stabilization function switch, priority is given to the lens side setting.
- You may notice an operating sound or vibration when the image stabilizer is activated.

Using lenses other than Micro Four Thirds/Four Thirds System lenses

You can use focal length information to reduce camera shake when shooting with lenses that are not Micro Four Thirds or Four Thirds system lenses.

- Press the **INFO** button while [Image Stabilizer] is selected, use $\Delta \nabla \triangleleft \triangleright$ to highlight a focal length, and press the \odot button.
- Choose a focal length between 0.1 mm and 1000.0 mm.
- Choose the value that matches the one printed on the lens.
- Selecting [Reset] (basic) in Shooting Menu 1 does not reset the focal length.

Setting the image aspect

Choose the ratio of width to height for pictures according to your intent or your goals for printing or the like. In addition to the standard aspect (width-to-height) ratio of [4:3], the camera offers settings of [16:9], [3:2], [1:1], and [3:4].

- 1 Press the \odot button to display the LV super control panel.
- 2 Use $\Delta \nabla \triangleleft \triangleright$ to highlight Image Aspect, and then press the \odot button.
- 3 Use $\triangleleft \triangleright$ to choose a value, and then press the \odot button.







Image Aspect

- Image aspect can only be set for still images.
- JPEG images are recorded at the selected aspect ratio. RAW images are the same size as the image sensor and are recorded at an aspect ratio of 4:3 with a tag indicating the aspect ratio selected. A crop indicating the selected aspect ratio is displayed when images are played back.







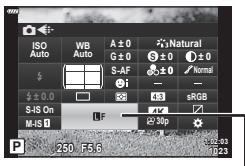







Photo File and Image Size Options (Still image quality,)

You can set an image quality mode for still images. Select a quality suitable for the application (such as for processing on PC, use on website etc.).

- 1 Press the  button to display the LV super control panel.
- 2 Use    to highlight still image quality, and then press the  button.



Still Image Quality









- 3 Highlight an option using  , and then press the  button.
 - Choose from JPEG (, , , and ) and RAW modes. Choose a JPEG+RAW option to record both a JPEG and a RAW image with each shot. JPEG modes combine image size (, , and ) and compression ratio (SF, F, and N).
 - When you want to select a combination other than , , , and , change the [ Set] (P. 148) settings in Custom Menu.



- RAW files store raw image data in an unprocessed state. Choose this format (extension “.ORF”) for pictures that will later be enhanced.
 - Cannot be viewed on other cameras
 - Can be viewed on computers using Olympus Workspace Digital Photo Managing software
 - Can be saved in JPEG format using the [RAW Data Edit] (P. 137) retouch option in the camera menus

Frame Size, Rate, and Compression (Movie quality,

Choose the image quality options available for movie recording. When choosing an option, consider how the movie will be used: for example, are you planning to process it on a computer, or is it intended for upload to a website?

- 1 Press the  button to display the LV super control panel.
- 2 Use     to highlight movie quality, and then press the  button.
- 3 Use   to choose an option, and then press the  button.

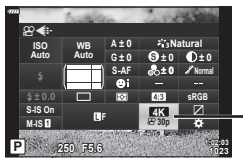

Movie Quality

2













Shooting

■ Available Movie Quality Options

















The options available for movie quality vary with the movie mode (P. 76) and the options selected for [Video Frame Rate] and [Video Bit Rate] in the video menu (P. 136).

- When shooting movies that will be viewed on a television, choose a frame rate that matches the video standard used in the device, as otherwise the movie may not play back smoothly. Video standards vary by country or region: some use NTSC, others PAL.
 - When shooting for display on NTSC devices, choose 60p (30p)
 - When shooting for display on PAL devices, choose 50p (25p)

The following options are available when the mode dial is rotated to a position other than :





Movie quality	Movie quality components
 3840×2160 30p	Choose the desired combination of frame size, bit rate, and frame rate. 
 3840×2160 25p	
 3840×2160 24p	
 1920×1080 Super Fine 60p	
 1920×1080 Super Fine 30p	
 1280×720 Super Fine 30p	
 1920×1080 Fine 60p	
 1920×1080 Fine 30p	
 1280×720 Fine 30p	
 1920×1080 Normal 60p	
 1920×1080 Normal 30p	

- 1 Frame size
 4K : 3840×2160
 FHD : 1920×1080
 HD : 1280×720
- 2 Bit rate (compression ratio)*1
 SF (Super Fine), F (Fine), N (Normal)
- 3 Frame rate
 30p (60p), 25p (50p), 24p

Movie quality	Movie quality components
 1280×720 Normal 30p	<p>Choose the desired combination of frame size, bit rate, and frame rate.</p>  <p>① Frame size 4K : 3840×2160 FHD : 1920×1080 HD : 1280×720</p> <p>② Bit rate (compression ratio)*1 SF (Super Fine), F (Fine), N (Normal)</p> <p>③ Frame rate 30p (60p), 25p (50p), 24p</p>
 1920×1080 Super Fine 50p	
 1920×1080 Super Fine 25p	
 1280×720 Super Fine 25p	
 1920×1080 Fine 50p	
 1920×1080 Fine 25p	
 1280×720 Fine 25p	
 1920×1080 Normal 50p	
 1920×1080 Normal 25p	
 1280×720 Normal 25p	
 1920×1080 Super Fine 24p	
 1280×720 Super Fine 24p	
 1920×1080 Fine 24p	
 1280×720 Fine 24p	
 1920×1080 Normal 24p	
 1280×720 Normal 24p	



*1 The bit rate can not be changed when the frame size is [4K].

The following options are available when the mode dial is rotated to  and [4K] is selected for movie mode *2:

Movie quality	Movie quality components
 3840×2160 30p	Choose the desired combination of frame size and frame rate. 
 3840×2160 25p	
 3840×2160 24p	
	① Frame size 4K : 3840×2160 ② Frame rate 30p, 25p, 24p

























*2 The bit rate can not be changed.

The following option is available when the mode dial is rotated to  and [High-speed] is selected for movie mode *3:

Movie quality	Movie quality components
 1280×720 HighSpeed 120fps	

*3 The frame rate and bit rate can not be changed.

The following options are available when the mode dial is rotated to  and [Standard] is selected for movie mode:

Movie quality	Movie quality components
 1920×1080 Super Fine 60p	<p>Choose the desired combination of frame size, bit rate, and frame rate.</p>  <p>① Frame size FHD : 1920×1080 HD : 1280×720</p> <p>② Bit rate (compression ratio) SF (Super Fine), F (Fine), N (Normal)</p> <p>③ Frame rate 30p (60p), 25p (50p), 24p</p>
 1920×1080 Super Fine 30p	
 1280×720 Super Fine 30p	
 1920×1080 Fine 60p	
 1920×1080 Fine 30p	
 1280×720 Fine 30p	
 1920×1080 Normal 60p	
 1920×1080 Normal 30p	
 1280×720 Normal 30p	
 1920×1080 Super Fine 50p	
 1920×1080 Super Fine 25p	
 1280×720 Super Fine 25p	
 1920×1080 Fine 50p	
 1920×1080 Fine 25p	
 1280×720 Fine 25p	
 1920×1080 Normal 50p	
 1920×1080 Normal 25p	
 1280×720 Normal 25p	
 1920×1080 Super Fine 24p	
 1280×720 Super Fine 24p	
 1920×1080 Fine 24p	
 1280×720 Fine 24p	
 1920×1080 Normal 24p	
 1280×720 Normal 24p	

- Movies are stored in MPEG-4 AVC/H.264 format. The maximum size of individual file is limited to 4 GB. The maximum recording time of individual movie is limited to 29 minutes.
- Depending on the type of card used, recording may end before the maximum length is reached.

Adjusting flash output (Flash intensity control)

Flash output can be adjusted if you find that your subject to appears overexposed, or is underexposed even though the exposure in the rest of the frame is just right.

- 1 Press the **OK** button to display the LV super control panel.
- 2 Use **Δ ▽ ◀ ▶** to select **[F5]**, and then press the **OK** button.
- 3 Use **◀ ▶** to choose a value, and then press the **OK** button.

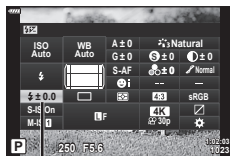

Flash intensity control

- This setting has no effect when the flash control mode for the external flash unit is set to MANUAL.
- Changes to flash intensity made with the external flash unit are added to those made with the camera.

Processing options (Picture Mode)

Choose how pictures are processed during shooting to enhance color, tone, and other properties. Choose from preset picture modes according to your subject or artistic intent. Contrast, sharpness, and other settings can be adjusted separately for each mode. You can also add artistic effects using art filters. Art filters give you the option of added frame effects and the like. Adjustments to individual parameters are stored separately for each picture mode and art filter.

- This item applies during both still photography and movie recording.



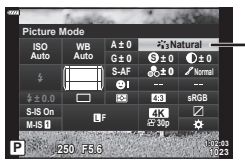





- 1 Press the **OK** button to display the LV super control panel.
- 2 Use **Δ ▽ ◀ ▶** to highlight picture mode, and then press the **OK** button.
- 3 Highlight an option using **◀ ▶**, and then press the **OK** button.



Picture Mode

- The options available for the picture mode vary depending on the shooting mode.

Picture mode options

 i-Enhance	The camera adjusts colors and contrast for optimal results according to the type of subject (P. 110).
 Vivid	Choose for vivid colors.
 Natural	Choose for natural colors.
 Muted	Choose for pictures that will later be retouched.
 Portrait	Enhance skin tones.
 Monochrome	Record pictures in monochrome. You can apply color filter effects and choose a tint (P. 109).
 Custom	Adjust picture mode parameters to create a custom version of a selected picture mode.
 e-Portrait	Smooth complexions.
 Color Creator	Adjust hue and color to suit your creative intent (P. 105).
ART 1 Pop Art * ¹	Uses Art Filter settings. Art effects can also be used.
ART 2 Soft Focus * ¹	
ART 3 Pale&Light Color	
ART 4 Light Tone	
ART 5 Grainy Film	
ART 6 Pin Hole * ¹	
ART 7 Diorama	
ART 8 Cross Process * ¹	
ART 9 Gentle Sepia	
ART 10 Dramatic Tone	
ART 11 Key Line	
ART 12 Watercolor	
ART 13 Vintage	
ART 14 Partial Color * ²	
ART 15 Bleach Bypass	
ART 16 Instant Film * ¹	
MONO 1 MONO Profile 1 * ³	Choose processing options for monochrome pictures. Furthermore, you can use each profile control (P. 46).
MONO 2 MONO Profile 2 * ³	
MONO 3 MONO Profile 3 * ³	
MONO 4 MONO Profile 4 * ³	
COLOR 1 Color Profile 1 * ³	Choose processing options for color pictures. Furthermore, you can use each profile control (P. 51).
COLOR 2 Color Profile 2 * ³	
COLOR 3 Color Profile 3 * ³	
COLOR 4 Color Profile 4 * ³	

*¹ After choosing [Pop Art I/II], [Soft Focus], [Pin Hole I/II/III], [Cross Process I/II] or [Instant Film] using <D>, press the **INFO** button to display the slider for Fine Tuning (P. 73).

*² After choosing [Partial Color I/II/III] using <D>, press the **INFO** button to display the color ring (P. 73).

*³ You can select these options while the profile control switch is in the COLOR/MONO position.

Adjusting overall color (Color Creator)

The overall color of the image can be adjusted using any combination of 30 hues and 8 saturation levels.

- Adjustments may not be available depending on the shooting mode and picture mode.

- 1 Press the **OK** button to display the LV super control panel.

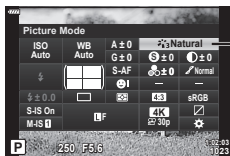

Picture Mode

- 2 Use **Δ** **▽** **◀** **▶** to highlight picture mode, and then press the **OK** button.
- 3 Highlight **☺** (Color Creator) using **◀** **▶**, and then press the **INFO** button.
- 4 Adjust saturation and hue.

- Rotate the front dial to adjust hue.
- Rotate the rear dial to adjust saturation.
- To restore default values, press and hold the **OK** button.



- 5 Press the **OK** button to save changes.
 - You can also save changes by pressing the shutter button halfway.
- Photos are recorded in RAW+JPEG format when [RAW] is selected for image quality (P. 98).
 - Pictures taken using [Multiple Exposure] (P. 131) are recorded at the [Natural] setting.

Making fine adjustments to sharpness (Sharpness)

Adjust image sharpness. Outlines can be emphasized for a sharp, clear picture. Settings are stored separately for each picture mode.

- Adjustments may not be available depending on the shooting mode and picture mode.

- 1 Press the **OK** button to display the LV super control panel.
- 2 Use **△ ▽ ◀ ▶** to select [Sharpness], and then press the **OK** button.
- 3 Use **◀ ▶** to choose a value, and then press the **OK** button.

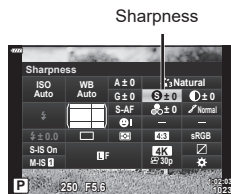

Making fine adjustments to contrast (Contrast)

Adjust image contrast. Increasing contrast heightens the difference between bright and dark areas for a harder, more well-defined picture. Settings are stored separately for each picture mode.

- Adjustments may not be available depending on the shooting mode and picture mode.

- 1 Press the **OK** button to display the LV super control panel.
- 2 Use **△ ▽ ◀ ▶** to select [Contrast], and then press the **OK** button.
- 3 Use **◀ ▶** to choose a value, and then press the **OK** button.

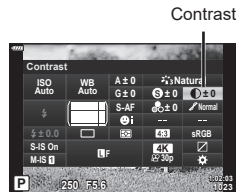

Making fine adjustments to saturation (Saturation)

Adjust color saturation. Increasing saturation makes pictures more vivid. Settings are stored separately for each picture mode.

- Adjustments may not be available depending on the shooting mode and picture mode.

- 1 Press the **OK** button to display the LV super control panel.
- 2 Use **△ ▽ ◀ ▶** to select [Saturation], and then press the **OK** button.
- 3 Use **◀ ▶** to choose a value, and then press the **OK** button.

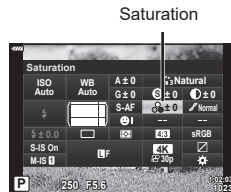

Adding a film grain effect to the Monochrome Profile (Film Grain Effect)

An effect similar to the grain seen in black-and-white film can be added to the in [MONO Profile 1/2/3/4] picture mode (P. 103) for later use.

- You can select these options while the profile control switch is in the COLOR/MONO position.

- 1 Press the **OK** button to display the LV super control panel.
- 2 Use **Δ ▽ ◀ ▶** to highlight picture mode, and then press the **OK** button.
- 3 Use **◀ ▶** to select an option from [Mono1] to [Mono4], and then press the **OK** button.

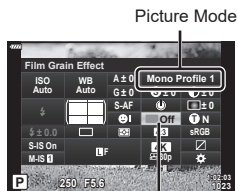

Film Grain Effect

- 4 Press the **OK** button again, use **Δ ▽ ◀ ▶** to highlight Film Grain Effect, and then press the **OK** button.
- 5 Highlight an option using **◀ ▶**, and then press the **OK** button.

Film Grain Effect Off	Film grain effect not applied.
Film Grain Effect Low	Add a fine-grain effect to images.
Film Grain Effect Medium	Add a grain effect between “low” and “high” to images.
Film Grain Effect High	Add a coarse-grain effect to images.

- Film grain effects can not be previewed in live view.

Making fine adjustments to tone (Gradation)

Adjust color brightness and shading. Bring pictures closer to what you envisage by, for example, brightening the entire picture. Settings are stored separately for each picture mode.

- Adjustments may not be available depending on the shooting mode and picture mode.

- Press the **OK** button to display the LV super control panel.
- Use **Δ ▽ ◀ ▶** to select [Gradation], and then press the **OK** button.
- Use **◀ ▶** to choose an option, and then press the **OK** button.

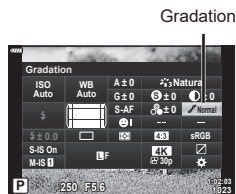

Auto (Shadow Adj)	Divides the image into detailed regions and adjusts the brightness separately for each region. This is effective for images with areas of large contrast in which the whites appear too bright or the blacks appear too dark.
Normal (Gradation Normal)	Optimal shading. Recommended in most circumstances.
High (Gradation High Key)	Uses a tone suitable for a bright subject.
Low (Gradation Low Key)	Uses a tone suitable for a dark subject.

Applying filter effects to monochrome pictures (Color Filter)

Color filter effects can be added when [Monochrome], [Grainy Film], or [Dramatic Tone] is selected for picture mode (P. 103). Depending on the color of the subject, color filter effects can make subjects brighter or enhance contrast. Orange adds more contrast than yellow, red more contrast than orange. Green is a good choice for portraits and the like.

- Press the **OK** button to display the LV super control panel.
- Use **Δ ▽ ◀ ▶** to highlight picture mode, and then press the **OK** button.
- Use **◀ ▶** to select **M** (Monochrome), **ART I/II** (Grainy Film I/II), or **ART II** (Dramatic Tone II), and then press the **OK** button.
- Press the **OK** button again, use **Δ ▽ ◀ ▶** to highlight Color Filter, and then press the **OK** button.
- Highlight an option using **◀ ▶**, and then press the **OK** button.

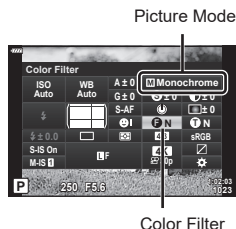

N:None	Creates a normal black and white image.
Ye:Yellow	Reproduces clearly defined white cloud with natural blue sky.
Or:Orange	Slightly emphasizes colors in blue skies and sunsets.
R:Red	Strongly emphasizes colors in blue skies and brightness of crimson foliage.
G:Green	Strongly emphasizes colors in red lips and green leaves.

Adjusting the tone of monochrome pictures (Monochrome Color)

Add a tint to black-and-white pictures in the [Monochrome], [Grainy Film], [Dramatic Tone], or [MONO Profile 1/2/3/4] picture mode (P. 103).

- 1 Press the OK button to display the LV super control panel.
- 2 Use $\Delta \nabla \langle \rangle$ to highlight picture mode, and then press the OK button.
- 3 Use $\langle \rangle$ to select M (Monochrome), ART I / ART II (Grainy Film I/II), ART III (Dramatic Tone II), or [MONO 1/2/3/4], and then press the OK button.

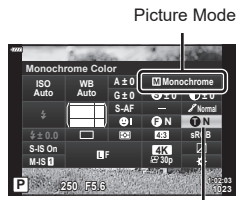

Monochrome Color

- 4 Press the OK button again, use $\Delta \nabla \langle \rangle$ to highlight Monochrome Color, and then press the OK button.
- 5 Highlight an option using $\langle \rangle$, and then press the OK button.

N:Normal	Creates a normal black and white image.
S:Sepia	Shoot in sepia-tinted monochrome.
B:Blue	Shoot in blue-tinted monochrome.
P:Purple	Shoot in purple-tinted monochrome.
G:Green	Shoot in green-tinted monochrome.

Adjusting i-Enhance effects

(Effect)

Choose the strength of the i-Enhance effect when [i-Enhance] is selected for picture mode (P. 103).

- 1 Press the **OK** button to display the LV super control panel.
- 2 Use $\Delta \nabla \triangleleft \triangleright$ to highlight picture mode, and then press the **OK** button.
- 3 Use $\triangleleft \triangleright$ to select  (i-Enhance), and then press the **OK** button.

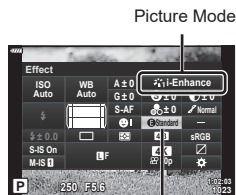

Effect

- 4 Press the **OK** button again, use $\Delta \nabla \triangleleft \triangleright$ to highlight Effect, and then press the **OK** button.
- 5 Highlight an option using $\triangleleft \triangleright$, and then press the **OK** button.

Low (Effect: Low)	Adds a low i-Enhance effect to images.
Standard (Effect: Standard)	Adds an i-Enhance effect between “low” and “high” to images.
High (Effect: High)	Adds a high i-Enhance effect to images.

Setting the color reproduction format

(Color Space)

You can select a format to ensure that colors are correctly reproduced when shot images are regenerated on a monitor or using a printer. This option is equivalent to the [Color Space] (P. 148) in Custom Menu.

- 1 Press the **OK** button to display the LV super control panel.
- 2 Use $\Delta \nabla \triangleleft \triangleright$ to select [Color Space], and then press the **OK** button.
- 3 Use $\triangleleft \triangleright$ to choose an option, and then press the **OK** button.

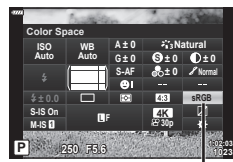

Color Space

sRGB	The established color space standard for Windows systems. It is widely supported across displays, printers, digital cameras, and computer applications. This setting is recommended in most circumstances.
AdobeRGB	A color space standard defined by Adobe Systems Inc. It can reproduce a wider gamut of colors than sRGB. Accurate color reproduction is available only with software and devices (displays, printers, and the like) that support this standard. An underscore (“_”) appears at the beginning of the file name (e.g., “_xxx0000.jpg”).

- [AdobeRGB] is not available in **AUTO** (, P. 54), **ART** (P. 70), **SCN** (P. 56), **AP** (P. 60), or movie () (P. 75) mode.

Changing the brightness of highlights and shadows (Highlight&Shadow Control)

Adjust brightness separately for highlights, mid-tones, and shadows. You gain greater control over exposure than you would with exposure compensation alone. You can selectively make highlights darker or shadows brighter.

- Adjustments may not be available depending on the shooting mode.

1 Press the **OK** button to display the LV super control panel.

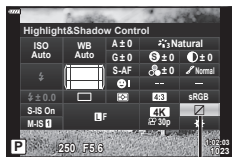

Highlight&Shadow Control

2 Use **Δ ▽ ◀ ▶** to select [Highlight&Shadow Control], and then press the **OK** button.

3 Press the **INFO** button to choose the desired tone range.

- The tone range changes each time the button is pressed.

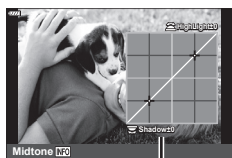

Selected tone range

4 Rotate the dials to choose the desired setting.

- **[Hi. & Sh.] (Highlight&Shadow) selected**
Adjust highlights using the front dial and shadows using the rear dial.
- **[Midtone] selected**
Use the front or rear dial.
- Press and hold the **OK** button to restore the default curve.

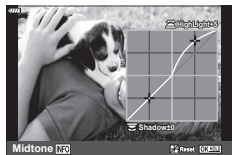

5 Press the **OK** button to save changes.

- You can also save changes by pressing the shutter button halfway.

Assigning functions to buttons (Button Function)

Other roles can be assigned to buttons in place of their existing functions.

■ Customizable Controls

Button	Default
Function	AEL/AF-L
Function	REC

To change the function assigned to a button, follow the steps below.

- 1 Press the button to display the LV super control panel.
- 2 Use to select [Button Function], and then press the button.
 - The custom menu [Button Function] item will be displayed.
 - [Button Function] can also be accessed from the menus (P. 128, 145).
- 3 Use to highlight the desired button, and then press .
- 4 Use to highlight the desired function, and then press the button.
- 5 Press the button again to exit.

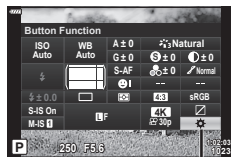





Button Function



- The functions assigned to the buttons may be unavailable in some modes.
- The options available vary with the current mode.



■ Available Roles

(AEL/AF-L)	Press the button to use AE lock or AF lock. The function changes according to the [AEL/AF-L] (P. 151) setting. When AEL is selected, press the button once to lock the exposure and display on the monitor. Press the button again to cancel the lock.
REC	Press the button to record a movie.
(Preview)	Aperture is stopped down to the selected value while the button is pressed.
(One-touch white balance)	Press the shutter button while the button is pressed to acquire a white balance value (P. 95). Highlight the desired number and press the button to save the value.
(AF Area Select)	Press the button to choose the AF target (P. 81).
MF	Press the button to select [MF] mode. Press the button again to restore the previously selected AF mode. The focus mode can also be selected by holding the button and rotating a dial.

 (Exposure compensation)	Press the button to adjust exposure compensation. In P , A , S , ART , AP , and movie modes, you can adjust exposure compensation by pressing the button and using \triangleleft or the front or rear dial to choose the desired value. In M mode, you can adjust shutter speed or aperture by pressing the button and using $\triangle \nabla \triangleleft$ or the front or rear dial to choose the desired values. In B mode, you can switch between bulb/time photography and live composite photography by pressing the button and using the rear dial or $\triangle \nabla$, or using front dial or \triangleleft to choose the desired aperture values.
 (Digital Tele-converter)	Press the button to turn digital zoom [On] or [Off] (P. 130).
 (Magnify)	Press the button to display the magnification frame and press it again to magnify the image. Press and hold the button to cancel magnified display.
Peaking	Press the button to turn on and off the peaking display. When peaking is displayed, histogram and highlight/shadow display are not available (P. 151).
 (Switch  Lock)	Press and hold the button to enable and disable touch screen operation.
Off	The control is not used.

■ Locking the exposure (AE Lock)

You can lock the exposure by pressing the **AEL/AFL** button. Use this when you want to adjust the focus and exposure separately or when you want to shoot several images at the same exposure.

- If you press the button to which **AEL** has been assigned once, the exposure is locked and **AEL** is displayed.  "AEL/AFL" (P. 151)
- Press the button to which **AEL** has been assigned once again to release the AE Lock.
- The lock will be released if you operate the mode dial, profile control switch, **MENU** button, or  button.

Zoom frame AF/Zoom AF (Super Spot AF)

You can zoom in on the display during shooting. For greater precision during focusing, zoom in on the focus area. At higher zoom ratios, you can focus on areas smaller than the standard focus target. You can reposition the focus area as desired during zoom.

- To use Super Spot AF, you must first assign [**Q**] to a button with [Button Function] (P. 112).

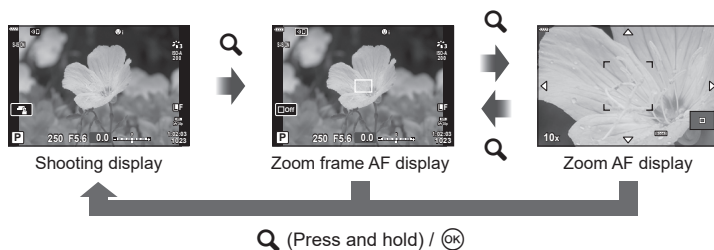

- 1 Press the button to which [Q] (magnify) is assigned.
 - The zoom frame will be displayed.
 - The frame is displayed in the same position as the target most recently used for autofocus.
- 2 Use $\Delta \nabla \triangleleft \triangleright$ to position the zoom frame.
 - To re-center the frame, press and hold the \odot button.
- 3 Adjust the size of the zoom frame to choose the zoom ratio.
 - Press the **INFO** button and then use $\Delta \nabla$ or the front or rear dial to adjust the size of the zoom frame.
 - Press the \odot button to accept and exit.
- 4 Press the button to which [Q] is assigned once more.
 - The camera will zoom the selected area in to fill the display.
 - Use the front or rear dial to zoom in or out.
 - You can also scroll the display using $\Delta \nabla \triangleleft \triangleright$.
 - In **M** mode or **B** mode, you can press the **INFO** button during zoom to choose aperture or shutter speed.
 - Press the **Q** button to return to the zoom frame.
 - Press the \odot button to end focus zoom.
 - You can also end focus zoom by pressing and holding the **Q** button.

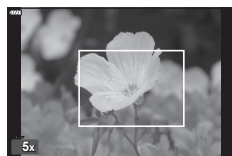
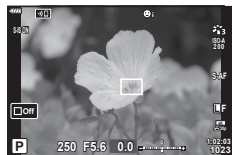

Exposure adjustment display for **M/B** mode







- 5 Press the shutter button halfway to focus using autofocus.
 - Focus zoom applies to the display only. Pictures taken with the camera are not affected.



- Touch controls can be used for focus zoom.  "Shooting with touch screen operations" (P. 32)

Choosing an Exposure Mode (Mode (Movie Exposure Modes))

Adjust aperture and shutter speed to suit your artistic intent. This option takes effect when the mode dial is rotated to .

- 1 Rotate the mode dial to .
- 2 Press the  button and use   to highlight movie (exposure) mode.
- 3 Use   to choose a value, and then press the  button.



Movie (exposure) mode

P	Exposure is automatically adjusted in response to subject brightness. Use the front dial to adjust exposure compensation.
A	Depiction of background is changed by setting the aperture. Use the front dial to adjust exposure compensation and rear dial to adjust aperture.
S	Shutter speed affects how the subject appears. Use the front dial to adjust exposure compensation and rear dial to adjust shutter speed.
M	Aperture and shutter speed can be manually set. Use the front dial to select aperture value and the rear dial to select shutter speed.

- In the **P**, **A**, or **S** mode, the ISO sensitivity is locked to [AUTO].
- In the **M** mode, the ISO sensitivity can only be set manually to values between 200 and 6400.
- In the **S** or **M** mode, the shutter speed can be set to values between 1/24 s and 1/4000 s.
- Blurred frames caused by such factors as the subject moving during shooting can be reduced by selecting the fastest available shutter speed.
- The low end of the shutter speed changes according to the frame rate of the movie record mode.



- You can choose the functions performed by the front and rear dials.  [Dial Function] (P. 145)

3 Playback

Information display during playback

Playback image information

Simplified display

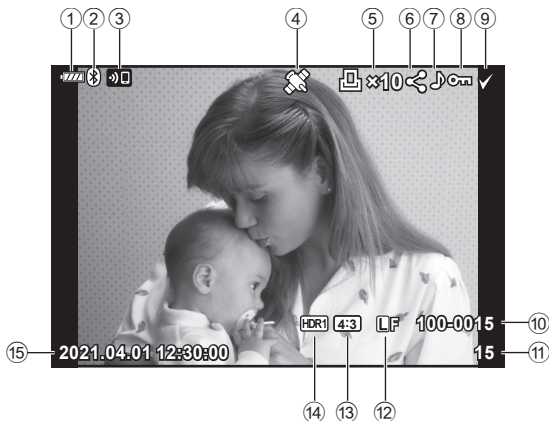

Overall display

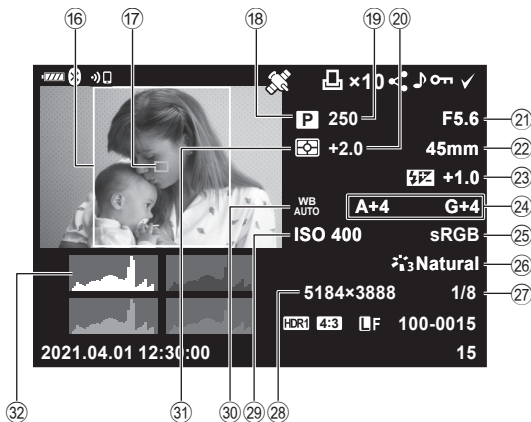

① Battery level.....P. 22	⑩⑥ Aspect borderP. 97
② Bluetooth ® connection statusP. 155–163	⑩⑦ AF area pointer.....P. 82
③ Wireless LAN connection.....P. 155–163	⑩⑧ Shooting mode.....P. 29–75
④ Including GPS information.....P. 162	⑩⑨ Shutter speedP. 35–41
⑤ Print order Number of printsP. 123	⑩⑩ Exposure compensationP. 81
⑥ Share order.....P. 122	⑩⑪ Aperture valueP. 35–41
⑦ Sound recordP. 124	⑩⑫ Focal length
⑧ ProtectP. 121	⑩⑬ Flash intensity control.....P. 103
⑨ Image selectedP. 122	⑩⑭ White balance compensation.....P. 96
⑩ File number.....P. 149	⑩⑮ Color space.....P. 110
⑪ Frame number	⑩⑯ Picture mode.....P. 103, 130
⑫ Image qualityP. 98	⑩⑰ Compression rateP. 154
⑬ Aspect ratio.....P. 97	⑩⑱ Pixel countP. 154
⑭ HDR imageP. 64	⑩⑲ ISO sensitivity.....P. 83
⑮ Date and timeP. 23	⑩⑳ White balance.....P. 94
	⑩㉑ Metering mode.....P. 93
	⑩㉒ HistogramP. 28

Switching the information display

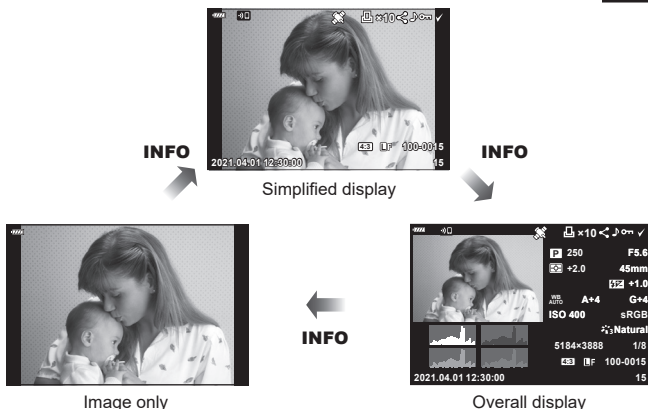
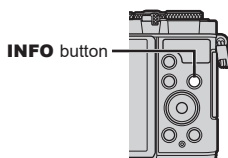

You can switch the information displayed during playback by pressing the **INFO** button.











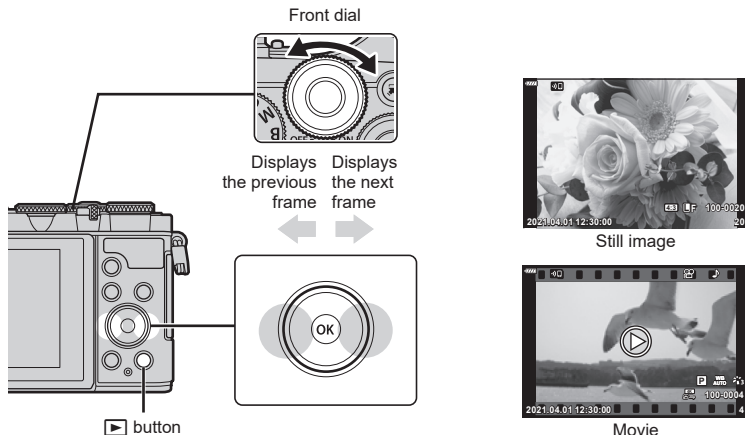









- You can add histogram and highlight & shadow to the information displayed during playback. [**Info**] (P. 152)

Viewing photographs and movies

1 Press the button.

- A photograph or movie will be displayed.
- Select the desired photograph or movie using the front dial or  .
- To return to shooting mode, press the shutter button halfway or press the  button.



Rear dial	Zoom in () / Index ()
Front dial	Previous () / Next () Operation also available during close-up playback.
Arrow pad () () () ()	Single-frame playback: display the next frame () / display the previous frame () / jump ahead 10 frames () / jump back 10 frames () Close-up playback: Changing the close-up position You can display the next frame () or the previous frame () during close-up playback by pressing the INFO button. Index/calendar playback: Highlight image
INFO button	View image info
 () button	Select images for sharing (P. 122)
AEL/AFL button	Protect picture (P. 121)
 button	Delete picture (P. 121)
 button	View menus (in calendar playback, press this button to exit to single-frame playback)

Finding Pictures Quickly (Index and Calendar Playback)

- In single-frame playback, rotate the rear dial to (☺) for index playback. Rotate further for calendar playback.
- Turn the rear dial to (☺) to return to single-frame playback.



- You can change the number of frames for index display. [Settings] (P. 152)



- Touch controls can also be used (P. 126).

Zooming In (Playback Zoom)

In single-frame playback, turn the rear dial to (☺) to zoom in. Turn to (☺) to return to single-frame playback.

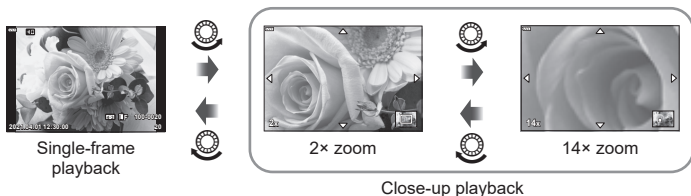

- Touch controls can also be used (P. 126).

Rotating Pictures (Rotate)

Choose whether to rotate photographs.

- 1 Play the photograph back and press the button.
- 2 Select [Rotate] and press the button.
- 3 Press to rotate the image counterclockwise, to rotate it clockwise; the image rotates each time the button is pressed.
 - Press the button to save settings and exit.
 - The rotated image is saved in its current orientation.
 - Movies and protected images cannot be rotated.



- The camera can be configured to automatically rotate portrait-orientation pictures during playback. playback menu > (P. 137)
[Rotate] is not available when [Off] is selected for .

Viewing Images as a Slideshow



This function displays images stored on the card one after another.

- 1 Press the **OK** button in the playback display.
- 2 Select **[]** and press the **OK** button.

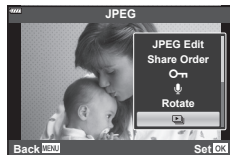

- 3 Adjust settings.

Start	Start the slideshow. Images are displayed in order, starting with the current picture.
BGM	Set [On] or [Off].
Slide	Set the type of data to be played back.
Slide Interval	Choose the length of time each slide is displayed from 2 to 10 seconds.
Movie Interval	Select [Full] to play back full length of each movie clip in the slideshow or [Short] to play back only the opening portion of each movie clip.

- 4 Select [Start] and press the **OK** button.
 - The slideshow will start.
 - Press **Δ**/**∇** during the slideshow to adjust the overall volume of the camera speaker. Press **◀**/**▶** while the volume adjustment indicator is displayed to adjust the balance between the sound recorded with the image or movie and background music.
 - Press the **OK** button to stop the slideshow.

Watching movies

Select a movie and press the **OK** button to display the playback menu. Select [Play Movie] and press the **OK** button to begin playback. Fast-forward and rewind using **</>**. Press the **OK** button again to pause playback. While playback is paused, use **△** to view the first frame and **▽** to view the last frame. Use **</>** or the front dial to view previous or next frame. Press the **MENU** button to end playback.



- Use **△** **▽** to adjust the volume during movie playback.



- Touch controls can also be used (P. 126).

Viewing Movies over 4 GB in Size

Long movies may exceed 4 GB in size. Movies over 4 GB in size are recorded over multiple files. The files can be played back as a single movie.

- 1 Display a long movie you want to view and press the **OK** button.

[Play from Beginning]:	Plays back a split movie all the way through
[Play Movie]:	Plays back files separately
[Delete entire]:	Deletes all parts of a split movie
[Erase]:	Deletes files separately

- We recommend using the latest version of Olympus Workspace to play back movies on a computer. Before launching the software for the first time, connect the camera to the computer.

Protecting Pictures



Protect images from accidental deletion. Display the image you want to protect and press the **AEL/AFL** button to add **OK** to the image (protection icon). Press the **AEL/AFL** button again to cancel protection. You can also protect multiple selected images.

OK (protect) icon

"Selecting Multiple Pictures (**OK**, Erase Selected, Share Order Selected)" (P. 122)



- Formatting the card erases all data including protected images.

Deleting Pictures



Display an image you want to delete and press the **OK** button. Select [Yes] and press the **OK** button.

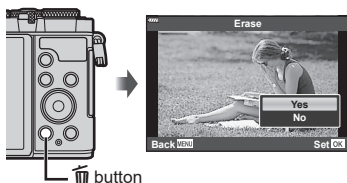

OK button

Selecting Pictures for Sharing

(Share Order)

You can select images you want to transfer to a smartphone in advance. You can also use **Share** to browse the images included in the share order. Display the image you want to transfer and press the **Share** button to set a share order. A **Share** icon will appear on the image. Press the **Share** button again to cancel a share order.

- You can select images you want to transfer in advance and set a share order all at once.
▶ “Selecting Multiple Pictures (On, Erase Selected, Share Order Selected)” (P. 122)
- You can automatically set a share order for JPEG images when you shoot photographs.
▶ “Automatically setting a share order for photographs” (P. 160)
- You can set a share order on 200 frames.
- Share orders cannot include RAW images.



If the **Share** button is currently assigned a role other than **Share**, assign it the **Share** role using the [▶ Function] option in the custom menu (P. 145).



Cancelling all share orders

(Reset share Order)

Cancel share orders that are set on images.

- Highlight [Reset share Order] in the ▶ playback menu and press the **OK** button.
- Select [Yes] and press the **OK** button.

Selecting Multiple Pictures

(On, Erase Selected, Share Order Selected)

You can select multiple images for [On], [Erase Selected] or [Share Order Selected].

- To select multiple images, you will first need to select [✓] for [▶ Function] (P. 145).

Press the **Share** button on the index display screen (P. 119) to select an image; a **Share** icon will appear on the image. Press the **Share** button again to cancel the selection.

Press the **OK** button to display the menu, and then select from [On], [Erase Selected] or [Share Order Selected]. This function is also available in single-frame playback.



- Touch controls can also be used (P. 127).

You can select pictures for printing and choose the number of copies and the information printed on each picture. The pictures can be printed at print shops that support the Digital Print Order Format (DPOF). A digital print order is stored on the memory card.

- 1 Press the **OK** button in the playback display.
- 2 Select [**Print Order**] and press the **OK** button.

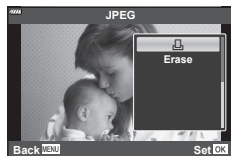

- 3 Select [**Print Order**] or [**Print Order ALL**] and press the **OK** button.

Individual picture

Press **Left/Right** to select the frame that you want to set as print reservation, then press **Up/Down** to set the number of prints.

- To set print reservation for several pictures, repeat this step. Press the **OK** button when all the desired pictures have been selected.

All pictures

Select [**Print Order ALL**] and press the **OK** button.

- 4 Select the date and time format and press the **OK** button.

No	The pictures are printed without the date and time.
Date	The pictures are printed with the shooting date.
Time	The pictures are printed with the shooting time.

- When printing images, the setting cannot be changed between the images.

- 5 Select [**Set**] and press the **OK** button.

- The setting will be applied to the images saved on the card being used for playback.
- The camera cannot be used to modify print orders created with other devices. Creating a new print order deletes any existing print orders created with other devices.
- Print orders cannot include RAW images or movies.



- Pictures can also be marked for printing using the **Print** button. If the **Print** button is currently assigned a role other than [**Print**], assign it the [**Print**] role using the [**Function**] option in the custom menus (P. 145).

Removing all or selected pictures from the print order

You can reset all print reservation data or just the data for selected pictures.

- 1 Press the **OK** button in the playback display.
- 2 Select [**Print Order**] and press the **OK** button.
- 3 Select [**Print Order**] and press the **OK** button.
 - To remove all pictures from the print order, select [Reset] and press the **OK** button. To exit without removing all pictures, select [Keep] and press the **OK** button.
- 4 Press **◀▶** to select images you wish to remove from the print order.
 - Use **▽** to set the number of prints to 0. Press the **OK** button once you have removed all the desired pictures from the print order.
- 5 Select the date and time format and press the **OK** button.
 - This setting is applied to all frames with print reservation data.
 - The setting will be applied to the images saved on the card being used for playback.
- 6 Select [Set] and press the **OK** button.

Adding Audio to Pictures



You can record audio using the built-in stereo microphone and add it to pictures. The recorded audio provides a simple replacement for written notes about the pictures.

- Audio recordings can be up to 30 s long.
- 1 Display the image to which you want to add audio and press the **OK** button.
 - Audio recording is not available with protected images.
 - Audio can also be added to pictures using the [Edit] option in the playback menu. Use [Edit] > [Sel. Image] to select the picture, then press the **OK** button and select [**Audio**].
 - 2 Select [**Audio**] and press the **OK** button.
 - To exit without adding audio, select [No].
 - 3 Select [**Start**] and press the **OK** button to begin recording.
 - 4 Press the **OK** button to end recording.
 - Images recorded with audio are indicated by a **♪** icon.

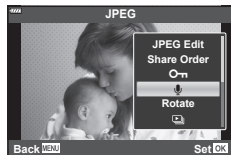

- To delete recorded audio, select [Erase] in Step 3.

Audio Playback



If an audio recording is available for the current picture, pressing the **OK** button will display audio playback options. Highlight [Play **♪**] and press the **OK** button to begin playback. To end playback, press the **OK** or **MENU** button. During playback, you can press **△▽** to raise or lower the volume.



- Audio recordings can also be played back using touch controls (P. 126).

Scrolling Panoramas





Panoramas made up of multiple images joined together can be viewed in a scrolling display.

1 Select a panorama in single-frame playback.

2 Turn the rear dial to .

- Use     to scroll.



- During playback, you can turn the rear dial further to  to zoom in from 2x to 14x or turn it to  to zoom out. Press the  button to return to single-frame playback.
- To view other images at zoom ratios above 2x, press the **INFO** button and then press  . Press the **INFO** button again to re-enable scrolling. You can also view other images using the front dial.



- Touch controls can also be used (P. 126).

Using the touch screen

You can use the touch screen to manipulate images.

- Do not tap the display with your fingernails or other sharp objects.
- Gloves or monitor covers may interfere with touch screen operation.

Single-frame playback

■ Displaying the previous or next image

- Slide your finger to the left to view the next image, and right to view the previous image.





■ Magnify

- Lightly tap the screen to display the slider and .
- Slide the bar up or down to zoom in or out.
- Slide your finger to scroll the display area when the picture is zoomed in.



■ Audio playback/Movie playback





- Tap  to start playback.
- To adjust volume during playback, place a finger on the display and slide it up or down.
- Movie playback can be paused by tapping the display. Tap again to resume playback.
- While playback is paused, you can slide the playback position indicator at the bottom of the screen left or right to choose a new starting point.
- Tap  to end playback.



Index/Calendar playback

Lightly tapping the display during single-frame playback displays a  icon. Tap  to display index playback. Tap  for calendar playback.

■ Displaying the previous or next page

- Slide your finger up to view the next page, and down to view the previous page.
- Tap  or  to switch the number of images displayed.   [Settings] (P. 146)
- Tap  several times to return to single-frame playback.

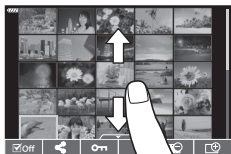





■ Viewing images

- Tap an image to view it full frame.

Selecting and protecting images

To view the touch menu, lightly tap the display (single-frame playback) or tap the  icon (index playback). You can then perform the desired operation by tapping the icons in the touch menu.



	Select an image. You can select multiple images and delete them collectively.
	Images you want to share with a smartphone can be set.  "Selecting Pictures for Sharing (Share Order)" (P. 122)
	Protects an image.

Viewing pictures in self-portrait mode

After taking photos in the self-portrait mode (P. 78), tap  to switch to the playback mode.

■ Displaying the previous or next image

The controls are the same as for single-frame playback (P. 126).

■ Magnify

The controls are the same as for single-frame playback (P. 126).

■ Audio playback/Movie playback

The controls are the same as for single-frame playback (P. 126).

■ Selecting pictures for sharing

- Tap the monitor to display the share icon.
- Tap  to select pictures for sharing.

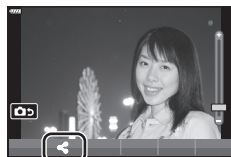

■ Returning to shooting mode

- Tap  to return to shooting mode (P. 78).



- The **INFO** button is disabled in self-portrait mode.

Basic menu operations

The menus can be used to customize the camera for ease of use and include shooting and playback options not accessible via the LV control, LV super control panel, or the like.

Tab	Tab name	Description
	Shooting Menu 1	Photography-related items. Ready the camera for shooting or access photo settings.
	Shooting Menu 2	
	Video Menu	Items related to movie recording. Adjust basic and custom settings.
	Playback Menu	Playback- and retouch-related items.
	Custom Menu	Items for customizing the camera.
	Setup Menu	Items for setting the clock, choosing a language, and the like.

Functions that cannot be selected from menus

Some items may not be selectable from the menus when using $\Delta \nabla \triangleleft \triangleright$.

- Items that cannot be set with the current shooting mode.
- Items that cannot be set because of an item that has already been set: Settings such as picture mode are unavailable when the mode dial is rotated to .

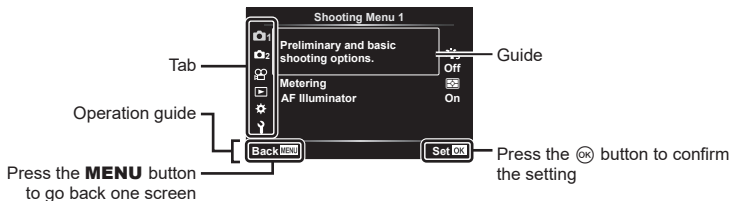
1 Press the **MENU** button to display the menus.

- A guide is displayed in 2 seconds after you select an option.
- Press the **INFO** button to view or hide guides.

2 Use $\Delta \nabla$ to select a tab, and then press the **OK** button or \triangleright .

- The menu group tab appears when the Custom Menu is selected. Use $\Delta \nabla$ to select the menu group and press \triangleright .

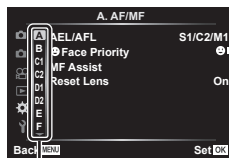

Menu group

- 3 Select an item using Δ / ∇ , and then press the OK button or \triangleright to display options for the selected item.

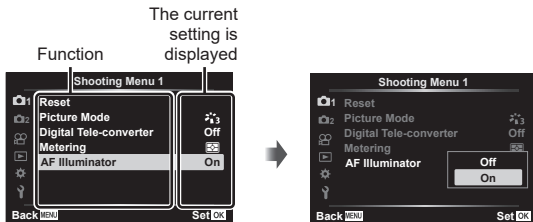

- 4 Use Δ / ∇ to highlight an option and press the OK button to select.
- Press the **MENU** button repeatedly to exit the menu.



- For the default settings of each option, refer to “Defaults” (P. 181).

Using Shooting Menu 1/Shooting Menu 2



Shooting Menu 1

- 1 Reset
- 2 Picture Mode (P. 103, 130)
- Digital Tele-converter (P. 130)
- Metering (P. 93)
- AF Illuminator (P. 130)

Shooting Menu 2

- 2 Image Stabilizer (P. 96)
- 3 Elec. Zoom Speed (P. 131)
- 4 (P. 103)
- Multiple Exposure (P. 131)
- Intrvl. Sh./Time Lapse (P. 133)
- Anti-Shock[\blacklozenge]/Silent[\heartsuit] (P. 135)
- 5 RC Mode (P. 135)



Returning to default settings (Reset)

Camera settings can be easily restored to default settings. You can opt to reset almost all settings or only those directly related to photography.

- 1 Select [Reset] in MENU Shooting Menu 1 and press \triangleright .
- 2 Highlight a reset option ([Full] or [Basic]) and press the OK button.
 - To reset all settings except the time, date, and a few others, highlight [Full] and press the OK button. MENU “Defaults” (P. 181)
- 3 Select [Yes] and press the OK button.

Processing options (Picture Mode)

You can make individual adjustments to contrast, sharpness and other parameters in [Picture Mode] (P. 103) settings. Changes to parameters are stored for each picture mode separately.

- 1 Select [Picture Mode] in  Shooting Menu 1 and press .
 - The camera will display the picture mode available in the current shooting mode.

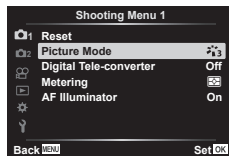





- 2 Select an option with   and press the  button.

- Press  to set the detailed options for the selected picture mode. Detailed options are not available for some picture modes.
- Changes to contrast have no effect at settings other than [Normal].

Digital Zoom (Digital Tele-converter)

This option takes a crop at the center of the frame the same dimensions as the size option currently selected for image quality and zooms it in to fill the display. The zoom ratio increases by about 2x. This allows you to zoom in past the lens' maximum focal length, making it a good choice when you are unable to switch lenses or find it difficult to get any closer to your subject.

- 1 Select [Digital Tele-converter] in  Shooting Menu 1 and press .
- 2 Highlight [On] and press the  button.
- 3 Press the **MENU** button to exit the menu.

- When [On] is selected, the zoom ratio increases by 2x and a  icon is displayed. Pictures will be recorded at the new zoom ratio.

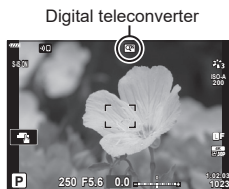

- Digital zoom is not available when panorama, multiple exposure, or keystone compensation is selected.
- When a RAW image taken with [On] selected for [Digital Tele-converter] is displayed, the area visible in the monitor is indicated by a frame.
- AF target drops.

Improving Focus in Dark Surroundings (AF Illuminator)

The AF illuminator (AF assist lamp) lights to assist the focus operation in dark environments. Select [Off] to disable AF illuminator.

- To use the AF illuminator during silent photography, you will need to change the option selected for [Silent ] Mode Settings (P. 135).

Choosing a Zoom Speed (📷 Elec. Zoom Speed)

Choose the speed at which power zoom lenses zoom in or out when the zoom ring is rotated. Adjust zoom speed if it is so quick that you find it hard to frame your subject.

- 1 Highlight [📷 Elec. Zoom Speed] in  Shooting Menu 2 and press \triangleright .
- 2 Select an option with $\Delta \nabla$ and press the OK button.

Recording multiple exposures in a single image (Multiple Exposure)

Take two shots and combine them into a single picture. Alternatively, you can take a shot and combine it with an existing picture stored on the memory card.

The combined image is recorded at current image quality settings. Only RAW pictures can be selected for multiple exposures that include an existing image.

If you record a multiple exposure with RAW selected for [📷📷], you can then select it for subsequent multiple exposures using [Overlay], allowing you to create multiple exposures combining three or more photographs.

- You can select [Multiple Exposure] in the **P/A/S/M/B** mode when the profile control switch is not in the COLOR/MONO position.
- 1 Select [Multiple Exposure] in  Shooting Menu 2 and press \triangleright .

- 2 Use $\Delta \nabla$ to select the item and press \triangleright .
 - Use $\Delta \nabla$ to select the setting and press the OK button.

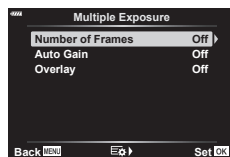

Number of Frames	[Off]: Do not create additional multiple exposures. [2f]: Create a multiple exposure from 2 pictures.
Auto Gain	[On]: Halve the brightness of each picture in the multiple exposure. [Off]: Do not adjust brightness the brightness of the pictures in the multiple exposure.
Overlay	[On]: Shoot a multiple exposure that includes an existing RAW image stored on the memory card. [Off]: Create a multiple exposure from the next 2 pictures taken. <ul style="list-style-type: none">• [Overlay] is only available when [2f] is selected for [Number of Frames].

- 3 If [On] is selected for [Overlay], you will be prompted to choose a picture for the multiple exposure.
 - Highlight a picture using $\Delta \nabla \triangleleft \triangleright$ and press the OK button.
 - Only RAW images can be selected.

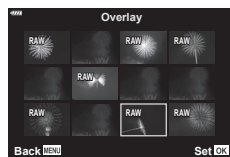



- 4 Press the OK button in the multiple exposure menu to save the selected settings.
 - The shooting menu will be displayed.

5 Press the **MENU** button to exit the menus.

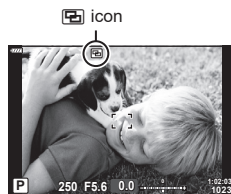

- A  icon will be displayed.
- If [Overlay] is selected, the chosen photograph will be visible superimposed on the view through the lens.



6 Take pictures.

- The first shot (or if [Overlay] is selected, the previously chosen photograph) will be visible superimposed on the view through the lens as you compose the next shot. If the chosen photograph is not superimposed on the view through the lens, repeatedly press the **INFO** button until it is superimposed.
- The  icon turns green.
- Normally, a multiple exposure will be created after the second shot is taken.
- Pressing the  button allows you to retake the first shot.
- If [On] is selected for [Overlay], you can take additional pictures that will be overlaid on the previously-chosen photograph.

7 Press the **MENU** button or press the button to end multiple exposure photography.

- If you end multiple exposure photography by pressing the **MENU** button, [Off] will be selected for [Number of Frames] in the multiple exposure menu.
- The  icon clears from the display when multiple exposure photography ends.
- The camera will not enter sleep mode during multiple exposure photography.
- Pictures taken with other cameras cannot be used for multiple exposures.
- The RAW pictures listed in the image-selection display when [On] is selected for [Overlay] are those processed using the settings in effect at the time the photograph was taken.
- The image-selection display for [Overlay] shows the RAW copies of photographs taken with RAW + JPEG selected for image quality.
- Exit multiple exposure mode before adjusting shooting settings. Some settings cannot be adjusted while multiple exposure mode is in effect.
- Performing any of the following operations after the first shot is taken ends multiple exposure photography:
 - The camera is turned off; the  button is pressed; the **MENU** button is pressed; the mode dial is rotated; the profile control switch is rotated; the battery power runs out; or any cable is connected to the camera
- Live composite photography ([LIVE COMP]) is not available in mode **B**.
- This function cannot be used with interval-timer photography or a digital teleconverter.
- Pictures taken with RAW selected for  can also be overlaid during playback.

Shooting automatically with a fixed interval (Intrvl. Sh./Time Lapse)

You can set the camera to shoot automatically with a set time lapse. The shot frames can also be recorded as into a single movie. This setting is only available in **P/A/S/M** modes.

- 1 Highlight [Intrvl. Sh./Time Lapse] in  Shooting Menu 2 and press .

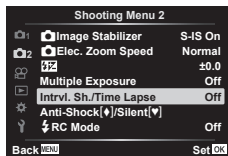

- 2 Select [On] and press .
- 3 Adjust the following settings and press the  button.

Number of Frames	Sets the number of frames to be shot.
Start Waiting Time	Sets waiting time before starting to shoot.
Interval Length	Sets interval between shots after shooting starts.
Time Lapse Movie	Sets recording format of frame sequence. [Off]: Records each frame as a still picture. [On]: Records each frame as a still picture and generates a single movie from the frame sequence.
Movie Settings	[Movie Resolution]: Choose a size for time lapse movies. [Frame Rate]: Choose a frame rate for time lapse movies.

- The starting and ending times shown in the display are intended as a guide only. The actual times may vary with shooting conditions.

- 4 The [Off]/[On] options will be displayed once more; confirm that [On] is highlighted and press the  button again.

- Press the MENU button to exit the menus.
- A  icon will appear in the shooting display (the icon shows the selected number of shots).

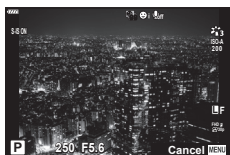

- 5 Shoot.
 - The  icon will turn green and the number of shots remaining will be displayed.

- Frames are shot even if the image is not in focus after AF. If you wish to fix the focus position, shoot in MF.
- [Rec View] (P. 143) operates for 0.5 seconds.
- If either of the time before shooting, or shooting interval is set to 1 minute 31 seconds or longer, the monitor and camera power will turn off after 1 minute. 10 seconds before shooting, the power will automatically turn on again. When the monitor is off, press the shutter button to turn it on again.
- If the AF mode (P. 92) is set to [C-AF] or [C-AF+TR], it is automatically changed to [S-AF].
- Touch operations are disabled during time lapse shooting.
- This function cannot be used with multiple exposure.
- The flash will not work if the flash charging time is longer than the interval between shots.
- If any of still pictures are not recorded correctly, the time lapse movie will not be generated.
- If there is insufficient space on the card, the time lapse movie will not be recorded.
- The following cancel time-lapse shooting:
using the mode dial, **MENU** button,  button, lens-release button, or profile control switch; connecting a USB cable; turning the camera off
- If there is not enough charge left on the battery, the shooting may end partway through. Make sure the battery is charged enough before shooting.
- Movies recorded with [4K] selected for [Movie Settings] > [Movie Resolution] may not display on some computer systems. More information is available on our website.

Setting anti-shock/silent shooting (Anti-Shock[♦]/Silent[♥])

You can set the operation of the shutter and related functions when shooting in the anti-shock mode (P. 88) and the silent mode (P. 88).

- These settings are not available in the **SCN** mode and **AP** mode.

- 1 Highlight [Anti-Shock[♦]/Silent[♥]] in **Shooting Menu 2** and press **▷**.

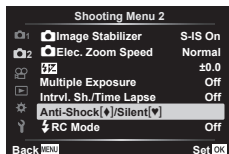

- 2 Select an option with **△ ▽** and press **▷**.
- 3 Adjust the following settings and press the **OK** button.

Anti-Shock[♦]	Sets the time period between the shutter button being pressed all the way down and the shutter release when shooting in anti-shock mode. Use this mode to suppress small vibrations caused by the operation of the shutter. Anti-shock mode is available in both sequential shooting and custom self-timer modes (P. 86).
Silent[♥]	Sets the time period between the shutter button being pressed all the way down and the shutter release when shooting in silent mode. Use this option in settings in which the sound of the shutter would be unwelcome. Silent mode supports both the custom self-timer and sequential shooting (P. 86).
Noise Reduction[▼]	Select [Auto] to reduce image “noise” in long exposures during silent photography. The sound of the shutter may be audible when noise reduction is active.
Silent[♥] Mode Settings	Choose whether to enable [■]), [AF Illuminator], or [Flash Mode] in silent mode. Select [Allow] to use current settings for the selected item, [Not Allow] to ignore current settings and disable the selected item.

Wireless remote control flash photography (⚡ RC Mode)

You can take wireless flash photographs using the built-in flash and a special flash with a remote control function. **☞** “Wireless remote control flash photography” (P. 170)

Using the Video Menu

Movie recording functions are set in the Video Menu.



Option	Description	
Movie	[Off]: Record movies without sound. [On]: Record movies with sound. [On]: Record movies with sound; wind noise reduction enabled.	—
Recording Volume	Adjust the sensitivity of the built-in microphone. Adjust the sensitivity using Δ ∇ while checking the peak sound level picked up by the microphone over the previous few seconds.	—
AF Mode	Choose the AF mode for movie recording.	92
Image Stabilizer	Sets image stabilization for movie recording.	96
Elec. Zoom Speed	Choose the speed at which electronic zoom lenses can be zoomed in or out during movie recording.	—
Video Frame Rate	Choose the frame rate for movie recording. • When shooting movies that will be viewed on a television, choose a frame rate that matches the video standard used in the device, as otherwise the movie may not play back smoothly. Video standards vary by country or region: some use NTSC, others PAL. - When shooting for display on NTSC devices, choose 60p (30p) - When shooting for display on PAL devices, choose 50p (25p)	99
Video Bit Rate	Choose the compression ratio for movie recording.	99

- Operation sounds of the lens and camera may be recorded in a movie. To prevent it from recording, reduce the operation sounds by setting [AF Mode] to [S-AF] or [MF], or by minimizing the button operations of the camera.
- Sound cannot be recorded in (Diorama) mode or in (High-speed) mode.
- When [Movie] is set to [Off], is displayed.

Using the Playback Menu

Playback Menu

 (P. 120)



Edit

Print Order (P. 123)

Reset Protect (P. 142)

Reset share Order (P. 122)

Device Connection (P. 156)

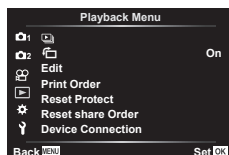

Automatically Rotating Portrait-Orientation Pictures for Playback



If set to [On], images in portrait orientation are automatically rotated to be displayed in the correct orientation on the playback display.

Retouching Pictures

































Create retouched copies of pictures. In the case of RAW pictures, you can adjust the settings in effect at the time the picture was taken, such as white balance and picture mode (art filters included). With JPEG pictures, you can make simple edits such as cropping and resizing.

RAW Data Edit	Retouch pictures and save the resulting copies in JPEG format. The following options are available: [Current]: Save the picture at the settings currently selected with the camera. [Custom1]/[Custom2]: Adjust settings while previewing the results in the display. The settings are saved as [Custom1] or [Custom2]. [ART BKT]: The camera creates multiple JPEG copies of each image, one for each art filter selected. Select one or more filters and apply them to one or more images.
JPEG Edit	Retouch JPEG pictures and save the resulting copies in JPEG format (P. 139).

Retouching RAW Pictures (RAW Data Edit)

[RAW Data Edit] can be used to adjust the following settings. These are also the settings applied when you select [Current].

- Image quality
 - Picture mode
 - White balance
 - Exposure compensation
 - Shadows
 - Mid-tones
 - Highlights
 - Aspect ratio
 - High ISO noise reduction
 - Color space
 - Keystone compensation
 - Fine tune
- [Color Space] is fixed at [sRGB] when an art filter is selected for picture mode.
- RAW pictures cannot be retouched if:
there is not enough space on the memory card or if the picture was created with a different camera

- 1 Select [Edit] in the  Playback Menu and press .
- 2 Use   to select [Sel. Image] and press the  button.
 - The pictures on the memory card will be displayed.
- 3 Use   to select the image to be edited and press the  button.
 - The editing menu will be displayed.
- 4 Highlight [RAW Data Edit] using   and press the  button.
 - Edit options will be displayed.
 - If the current picture is not a RAW image, [RAW Data Edit] is not available. Select a different image.
- 5 Highlight items using  .
 - To apply current camera settings, highlight [Current] and press the  button. Current settings will be applied.
 - Use   to select [Yes] and press the  button to record the developed image.
 - For [Custom1] or [Custom2], highlight the desired option and press , then edit settings as follows:
 - Retouch options will be displayed. Highlight items using   and use   to choose settings. Repeat until all the desired settings have been chosen. Press the  button to preview the results.
 - Press the  button to confirm the settings. The processing will be applied to the image.
 - Use   to select [Yes] and press the  button to record the developed image.
 - Highlighting [ART BKT] and pressing  displays a list of art filters. Highlight art filters and press the  button to select or deselect; selected filters are marked with a . Press the **MENU** button to return to the previous display once all the desired filters have been selected.
 - Press the  button to record the image after processing with the selected art filter.

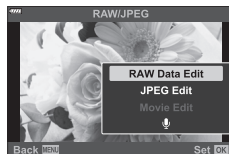
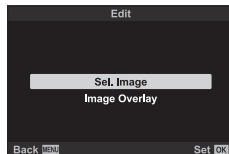

- 6** To create additional copies from the same original, highlight [Reset] and press the **OK** button. To exit without creating more copies, highlight [No] and press the **OK** button.



- Selecting [Reset] displays editing options. Repeat the process from Step 5.



- You can also edit selected pictures during playback.

▶ button → Display a picture you want to retouch → Press the **OK** button to view options → [RAW Data Edit]

Retouching JPEG Pictures (JPEG Edit)

The [JPEG Edit] menu contains the following options.

Shadow Adj.	Brighten back-lit subjects.
Red-eye Fix	Reduce "red-eye" in pictures taken with a flash.
	Crop pictures. Size the crop with the front or rear dial and position it with $\Delta \nabla \triangleleft \triangleright$.
Aspect	Change the aspect ratio from the standard 4:3 to [3:2], [16:9], [1:1], or [3:4]. After choosing an aspect ratio, use the arrow pad to position the crop.
Black & White	Create a black-and-white copy of the current picture.
Sepia	Create a sepia copy of the current picture.
Saturation	Adjust the vividness of colors. The results can be previewed in the display.
	Create a resized copy 1280 × 960, 640 × 480, or 320 × 240 pixels in size. Pictures with an aspect ratio other than the standard 4:3 are resized to dimensions as close as possible to the selected option.
e-Portrait	Smooth complexions. The desired effect may not be achieved if no faces are detected.

- Red-eye correction may not work depending on the image.
- Editing of a JPEG image is not possible in the following cases:
When an image is processed on a PC, when there is not enough space in the card memory, or when an image is recorded on another camera.
- The image cannot be resized () to the larger size than the original size.
- Some images can not be resized.
- [] (trimming) and [Aspect] can only be used to edit images with an aspect ratio of 4:3 (standard).

- 1** Select [Edit] in the **▶** Playback Menu and press **▶**.

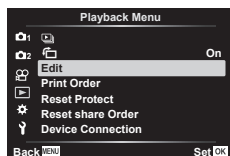

- 2 Use Δ ∇ to select [Sel. Image] and press the OK button.
 - The pictures on the memory card will be displayed.
 - 3 Use \triangleleft \triangleright to select the image to be edited and press the OK button.
 - Edit menu will be displayed.
 - 4 Highlight [JPEG Edit] using Δ ∇ and press the OK button.
 - Edit options will be displayed.
 - If the current picture is not a JPEG image, [JPEG Edit] is not available. Select a different image.
 - 5 Highlight items using Δ ∇ and press the OK button.
 - The effect can be previewed in the display. If multiple options are listed for the selected item, use Δ ∇ to choose the desired option.
 - When [Crop] is selected, you can size the crop using the dials and position it using Δ ∇ \triangleleft \triangleright .
 - When [Aspect] is selected, you can select an option using \triangleleft \triangleright , and then set the position using Δ ∇ \triangleleft \triangleright .
 - 6 Highlight [Yes] using Δ ∇ and press the OK button.
 - The new copy will be saved at the selected settings and the camera will return to the playback display.
- You can also access retouch options when a JPEG picture is displayed during playback:
 RETOUCH button \rightarrow Display a picture you want to retouch \rightarrow Press the OK button to view options \rightarrow [JPEG Edit]

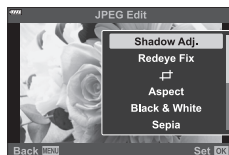
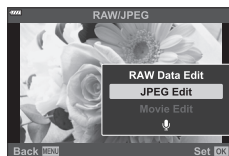
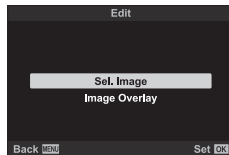

Overlay existing RAW photos and to create a new picture. Up to 3 pictures can be included in the overlay.

- 1 Select [Edit] in the Playback Menu and press .
- 2 Use to select [Image Overlay] and press the .
- 3 Select the number of images to be overlaid and press the .
- 4 Use to select the RAW images and press the to add them to the overlay.
 - The overlaid image will be displayed if images of the number specified in step 3 are selected.
- 5 Adjust the gain for each image to be overlaid.
 - Use to select an image and to adjust gain.
 - Gain can be adjusted in the range 0.1–2.0. Check the results in the monitor.
- 6 Press the button to display the confirmation dialog. Select [Yes] and press the button.

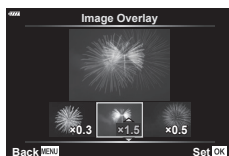
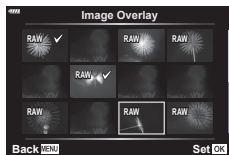

- The overlay is saved in the format currently selected for image quality. Overlays created with [RAW] selected for image quality are saved in the RAW+JPEG format (P. 148).
- Overlays saved in RAW format can in turn be combined with other RAW images to create overlays containing 4 or more pictures.

Creating Movie Stills

(In-Movie Image Capture)

Save a still copy of a selected frame.





















- This option is available only with [4K] movies recorded with the camera.
- 1 Select [Edit] in the Playback Menu and press .
 - 2 Use to select [Sel. Image] and press the .
 - 3 Use to select a movie and press the .
 - 4 Select [Movie Edit] and press the .
 - 5 Use to select [In-Movie Image Capture] and press the .
 - 6 Use to select a frame to be saved as a still image and press the button.
 - Use or to skip multiple frames.
- The date of recording of the still may differ from that of the original movie.



- We recommend using the latest version of Olympus Workspace to edit movies on a computer.

Trimming movies (Movie Trimming)

Cut selected footage from movies. Movies can be trimmed repeatedly to create files containing only footage you want to preserve.



- This option is available only with movies recorded with the camera.
- 1** Select [Edit] in the  Playback Menu and press .
 - 2** Use   to select [Sel. Image] and press the  button.
 - 3** Use   to select a movie and press the  button.
 - 4** Select [Movie Edit] and press the  button.
 - 5** Use   to select [Movie Trimming] and press the  button.
 - 6** Select [Overwrite] or [New File] and press the  button.
 - If the image is protected, you cannot select [Overwrite].
 - 7** Choose whether the section to be deleted begins with the first frame or ends with the last frame, using   to highlight the desired option and pressing the  button to select.
 - 8** Use   to choose the section to be deleted.
 - The section to be deleted is shown in red.
 - 9** Press the  button.
 - 10** Select [Yes] and press the  button.
 - The date of recording of the still may differ from that of the original movie.



- We recommend using the latest version of Olympus Workspace to edit movies on a computer.

Removing Protection from All Pictures (Reset Protect)



Protections of multiple images can be canceled at a time.

- 1** Select [Reset Protect] in the  Playback Menu and press .
- 2** Select [Yes] and press the  button.

Using the setup menu

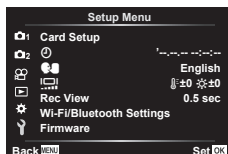
Adjust basic camera settings. Examples include language selection and monitor brightness. The setup menu also contains options used during the initial setup process.



Option	Description	
Card Setup	Format the card and delete all images.	144
⌚ (Date/time setting)	Set the camera clock.	23
🗣️ (Changing the display language)	Choose a language for camera menus and guides.	144
📺 (Monitor brightness adjustment)	<p>You can adjust the brightness and color temperature of the monitor. Use <◀▶> to highlight  (color temperature) or  (brightness) and $\Delta \nabla$ to adjust the value.</p> <p>Press the INFO button to switch the saturation of the monitor between [Natural] and [Vivid] settings.</p>	—
Rec View	<p>Sets whether to display the captured image on the monitor after shooting, and the length of time for the display. This is useful for a brief check of the picture you have taken. You can shoot the next shot by pressing the shutter button halfway even while the captured image is displayed on the monitor.</p> <p>[0.3sec]–[20sec]: Sets the length of time (seconds) to display the captured image on the monitor.</p> <p>[Off]: The captured image is not displayed on the monitor.</p> <p>[Auto ]: Displays the captured image, and then switches to playback mode. This is useful for erasing a picture after checking it.</p>	—
Wi-Fi/Bluetooth Settings	Adjust settings for connection to Wi-Fi/ Bluetooth compatible smartphones using the camera's wireless function.	158, 162, 163
Firmware	View the versions of the firmware for the camera and any lenses or other peripherals currently connected. You may need this information when contacting customer support or performing firmware updates.	—





Formatting the card

(Card Setup)

Cards must be formatted with this camera before first use or after being used with other cameras or computers.

All data stored on the card, including protected images, is erased when the card is formatted.

When formatting a used card, confirm there are no images that you still want to keep on the card.  “Usable cards” (P. 167)



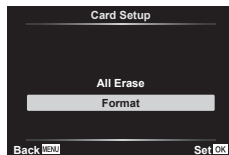

- 1 Select [Card Setup] in the  Setup Menu and press .
 - If there is data on the card, menu items appear. Select [Format] and press the  button.
- 2 Select [Yes] and press the  button.
 - Formatting is performed.



Deleting all images

(Card Setup)

All images on a card can be deleted at a time. Protected images are not deleted.



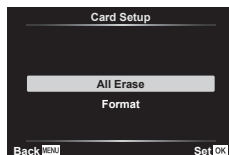





- 1 Select [Card Setup] in the  Setup Menu and press .
- 2 Select [All Erase] and press the  button.
- 3 Select [Yes] and press the  button.
 - All images are deleted.



Choosing a language



Choose a language for camera menus and guides.



- 1 Select  in the  Setup Menu and press .
- 2 Highlight the desired language using the front or rear dial or    .
- 3 Press the  button when the desired language is highlighted.



Using the custom menus

Camera settings can be customized using the  Custom Menu.

Custom Menu

- A** AF/MF
- B** Button/Dial
- C1/C2** Disp/■/PC (P. 146)
- D1/D2** Exp/ISO/BULB (P. 147)
- E**  Custom (P. 148)
- F**  WB/Color (P. 148)
- G** Record (P. 149)
- H**  Utility (P. 150)

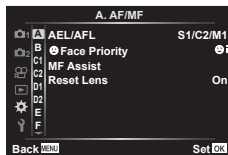





A AF/MF

MENU →  → **A**

Option	Description	
AEL/AFL	Customize AF and AE lock.	151
Face Priority	You can select the face priority or eye priority AF mode.	82
MF Assist	When set to [On], you can automatically switch to zoom or peaking in manual focus mode by rotating the focus ring.	151
Reset Lens	When set to [Off], the focus position of the lens is not reset even when the power is turned off. When set to [On], the focus of power zoom lenses is also reset.	—

B Button/Dial

MENU →  → **B**

Option	Description	
Button Function	Other roles can be assigned to buttons in place of their existing functions.	112
Function	Choose the role played by the  button during playback.  : Mark pictures for sharing.  : Select multiple pictures.  : Mark pictures for printing at a later date. The number of copies is set to 1. The date is not printed.	122, 123
Dial Function	You can change the function of the front dial and rear dial.	—

Option	Description	
Control Settings	For each shooting mode except movie, choose whether pressing the button displays LV controls or LV super controls.	89, 91
/Info Settings	Choose the information displayed when the INFO button is pressed. [▶ Info]: Choose the information displayed in full frame playback. [LV-Info]: Choose the information displayed when the camera is in shooting mode. [■ Settings]: Choose the information displayed in index and calendar playback.	152
Live View Boost	Adjust brightness for ease of viewing when lighting is poor. [Off]: Preview exposure in live view. Exposure can be previewed before shooting. • The setting automatically switches to [On2] during bulb or time photography. • The setting automatically switches to [On1] during zoom or preview display. [On1]: Exposure preview disabled; brightness is adjusted for ease of viewing. The brightness of the preview differs from the final photograph. [On2]: As for [On1] but brighter. Choose when framing shots of the night sky or the like. • The brightness of the preview differs from the final photograph. Subject motion may also appear slightly jerky.	—
Flicker Reduction	Reduce the effects of flicker under some kinds of lighting, including fluorescent lamps. When flicker is not reduced by the [Auto] setting, set to [50Hz] or [60Hz] in accordance with the commercial power frequency of the region where the camera is used.	—
Displayed Grid	Select [■], [■], [■], [■], [■] or [■] to display a grid on the monitor.	—
Peaking Color	Choose the color of the outlines (red, yellow, white, or black) in the focus peaking display.	151

Option	Description	
(Beep sound)	When set to [Off], you can turn off the beep sound that is emitted when the focus locks by pressing the shutter button.	—
HDMI	[Output Size]: Selecting the digital video signal format for connecting to a TV via an HDMI cable. [HDMI Control]: Select [On] to allow the camera to be operated using remotes for TVs that support HDMI control. This option takes effect when pictures are displayed on a TV.	153
USB Mode	Choose a mode for connecting the camera to a computer. Choose [Auto] to display USB mode options every time the camera is connected.	—

Option	Description	
Exposure Shift	Adjust correct exposure separately for each metering mode. <ul style="list-style-type: none"> • This reduces the number of exposure compensation options available in the selected direction. • The effects are not visible in the monitor. To make normal adjustments to the exposure, perform exposure compensation (P. 81). 	—
ISO-Auto Set	Choose the upper limit and default value used for ISO sensitivity when [Auto] is selected for ISO. [Upper Limit]: Choose the upper limit for auto ISO sensitivity selection. [Default]: Choose the default value for auto ISO sensitivity selection.	—
Noise Filter	Choose the amount of noise reduction performed at high ISO sensitivities.	—
Noise Reduct.	This function reduces the noise that is generated during long exposures. [Auto]: Noise reduction is performed at slow shutter speeds, or when the internal temperature of the camera has risen. [On]: Noise reduction is performed with every shot. [Off]: Noise reduction off. <ul style="list-style-type: none"> • The time required for noise reduction is shown in the display. • [Off] is selected automatically during sequential shooting. • This function may not work effectively with some shooting conditions or subjects. • When shooting in the silent mode, priority is given to the [Noise Reduction[♥]] setting in the [Anti-Shock[♦]/ Silent[♥]] menu (P. 135). 	43

Option	Description	
Bulb/Time Timer*¹	Choose the maximum exposure for bulb and time photography.	42
Live Bulb	Choose the display interval during shooting. The number of update times is limited. The frequency drops at high ISO sensitivities. Tap the monitor or press the shutter button halfway to refresh the display. Choose [Off] to disable the display.	
Live Time*¹		
Composite Settings*²	Set an exposure time to be the reference in composite photography.	44

*¹ Not applied to live-time photography in the **VA**P mode.

*² Not applied to Light Trails photography in the **SCN** mode or to Live Composite Photography in the **VA**P mode.

Option	Description	
⚡ X-Sync.	Choose the shutter speed used when the flash fires.	154
⚡ Slow Limit	Choose the slowest shutter speed available when a flash is used.	154
Ⓜ+Ⓜ	When set to [On], the exposure compensation value is added to the flash compensation value.	81, 103
⚡+WB	Adjust white balance for use with a flash.	—

Option	Description	
⏪- Set	<p>You can select the JPEG image quality mode from combinations of three image sizes and three compression rates.</p> <ol style="list-style-type: none"> Use ⏪⏩ to select a combination ([⏪-1] – [⏪-4]) and use ⏴⏵ to change. Press the OK button. 	98, 154
WB	Set the white balance. You can also fine-tune the white balance for each mode.	94, 96
WB AUTO Keep Warm Color	Select [On] to preserve “warm” colors in pictures taken under incandescent lighting.	95
Color Space	You can select a format to ensure that colors are correctly reproduced when shot images are regenerated on a monitor or using a printer.	110

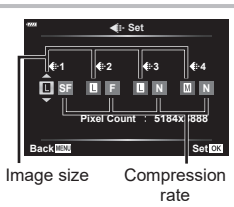

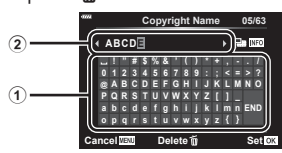
Option	Description	☞
<p>File Name</p>	<p>[Auto]: Even when a new card is inserted, the file numbers are retained from the previous card. File numbering continues from the last number used or from the highest number available on the card.</p> <p>[Reset]: When you insert a new card, the folder numbers starts at 100 and the file name starts at 0001. If a card containing images is inserted, the file numbers start at the number following the highest file number on the card.</p>	<p>—</p>
<p>Edit Filename</p>	<p>Choose how image files are named by editing the portion of the filename highlighted below in gray.</p> <p>sRGB: Pmdd0000.jpg _____ Pmdd Adobe RGB: _mdd0000.jpg _____ mdd</p> <div style="border: 1px solid gray; padding: 5px;"> <ol style="list-style-type: none"> 1) Highlight [sRGB] or [AdobeRGB] and press ▷. 2) Use ◀▷ to move the cursor and ▲▼ to edit the highlighted character. 3) Repeat Step 2 as necessary to create the desired filename and then press Ⓞ. </div>	<p>—</p>
<p>Copyright Settings*</p>	<p>Add the names of the photographer and copyright holder to new photographs. Names can be up to 63 characters long.</p> <p>[Copyright Info.]: Select [On] to include the names of the photographer and copyright holder in the Exif data for new photographs.</p> <p>[Artist Name]: Enter the name of the photographer.</p> <p>[Copyright Name]: Enter the name of the copyright holder.</p> <div style="border: 1px solid gray; padding: 5px;"> <ol style="list-style-type: none"> 1) Select characters from ① and press the Ⓞ button. The selected characters appear in ②. 2) Repeat Step 1 to complete the name, then highlight [END] and press the Ⓞ button. <ul style="list-style-type: none"> • To delete a character, press the INFO button to place the cursor in the name area ②, highlight the character, and press Ⓞ. </div> <div style="text-align: center; margin-top: 10px;">  </div> <p>* Our company does not accept liability for damages arising from disputes involving the use of [Copyright Settings]. Use at your own risk.</p>	<p>—</p>

Option	Description	
Pixel Mapping	The pixel mapping feature allows the camera to check and adjust the image pickup device and image processing functions.	175
Level Adjust	You can calibrate the angle of the level gauge. [Reset]: Resets adjusted values to the default settings. [Adjust]: Sets the current camera orientation as the 0 position.	—
Touchscreen Settings	Activate the touch screen. Choose [Off] to disable the touch screen.	—
Sleep	The camera will enter sleep (energy saving) mode if no operations are performed for the selected period. The camera can be reactivated by pressing the shutter button halfway.	—
Certification	Display certification icons.	—

AEL/AFL

MENU → → **A** → [AEL/AFL]

Autofocus and metering can be performed by pressing the **AEL/AFL** button. Choose a mode for each focus mode.

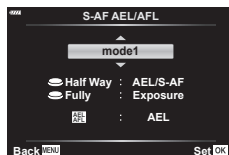

Assignments of AEL/AFL function

Mode		Shutter button pressed				AEL/AFL button	
		Halfway		All the way down		Kept pressed	
		AF	AE	AF	AE	AF	AE
S-AF	mode1	S-AF	Locked	–	–	–	Locked
	mode2	S-AF	–	–	Locked	–	Locked
	mode3	–	Locked	–	–	S-AF	–
C-AF	mode1	C-AF start	Locked	Ends	–	–	Locked
	mode2	C-AF start	–	Ends	Locked	–	Locked
	mode3	–	Locked	Ends	–	C-AF start	–
	mode4	–	–	Ends	Locked	C-AF start	–
MF	mode1	–	Locked	–	–	–	Locked
	mode2	–	–	–	Locked	–	Locked
	mode3	–	Locked	–	–	S-AF	–

Manual Focus Assist

(MF Assist)

MENU → → **A** → [MF Assist]

This is a focus assist function for MF. When the focus ring is rotated, the edge of the subject is enhanced or a portion of the screen display is magnified. When you stop operating the focus ring, the screen returns to the original display.

Magnify	Magnifies a portion of the screen. The portion to be magnified can be set in advance using AF target. "Setting the location of the focus (AF target position)" (P. 82)
Peaking	Displays clearly defined outlines with edge enhancement. You can choose the color of the outlines. [Peaking Color] (P. 146)

- When Peaking is in use, the edges of small subjects tend to be enhanced more strongly. This is no guarantee of accurate focusing.



- [Peaking] can be displayed using button operations. The display is switched every time the button is pressed. Assign the switching function to one of the buttons in advance using [Button Function] (P. 112).

Adding information displays

MENU → ⚙ → [i] → [Info Settings]

▶ Info (Playback information displays)

Use [▶ Info] to add the following playback information displays. The added displays are displayed by repeatedly pressing the **INFO** button during playback. You can also choose to not show displays that appear at the default setting.



Histogram display



Highlight & Shadow display

- The Highlight & Shadow display shows overexposed areas in red, underexposed areas in blue.

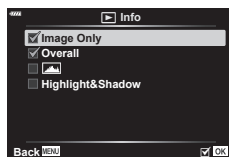

LV-Info (Shooting information displays)

The histogram, Highlight & Shadow, and level gauge displays can be added to [LV-Info]. Choose [Custom 1] or [Custom 2] and select the displays you wish to add. The added displays are displayed by repeatedly pressing the **INFO** button during shooting. You can also choose to not show displays that appear at the default setting.



⚙ Settings (Index/calendar display)

You can change the number of frames to be displayed on the index display and set to not display the screens that are set to be displayed by default with [⚙ Settings]. Screens with a check can be selected on the playback screen using the rear dial.

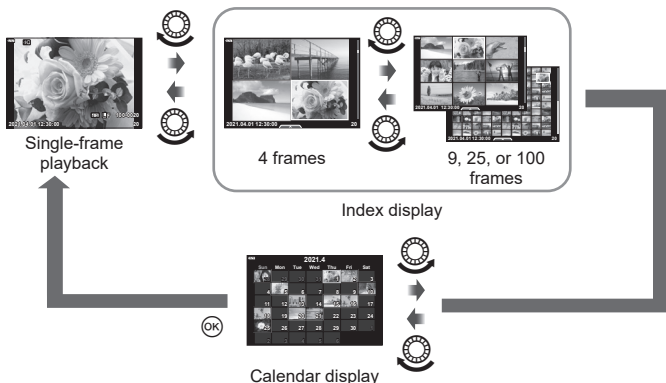
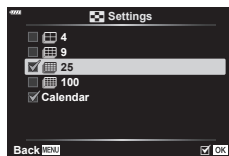

MENU → * → [Q] → [HDMI]

Use the separately sold cable with the camera to playback recorded images on your TV. This function is available during shooting. Connect the camera to an HD TV using an HDMI cable to view high-quality images on a TV screen.

- 1 Turn the camera off and connect it to the TV.

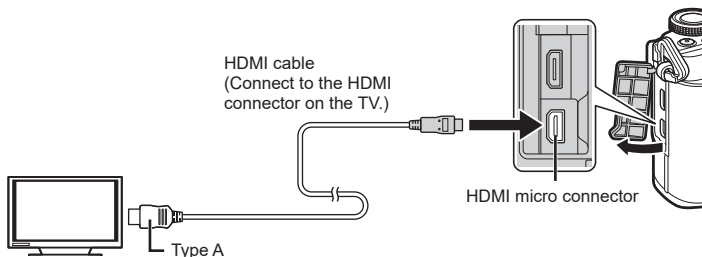

- The location of the HDMI connector varies with the TV. For details, refer to the TV's instruction manual.

- 2 Turn the camera on.

- 3 Switch the input source of the TV.

- The camera monitor turns off when it is connected via an HDMI cable.
- For details on changing the input source of the TV, refer to the TV's instruction manual.
- Depending on the TV's settings, the displayed images and information may become cropped.
- If the camera is connected via an HDMI cable, you will be able to choose the digital video signal type. Choose a format that matches the input format selected with the TV.

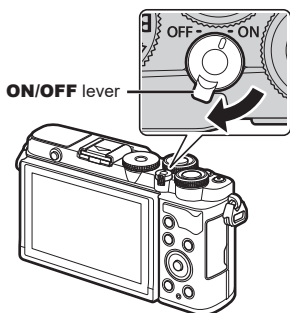

4K	Priority is given to 4K HDMI output.
1080p	Priority is given to 1080p HDMI output.
720p	Priority is given to 720p HDMI output.
480p/576p	480p/576p HDMI output.

- Do not connect the camera to other HDMI output devices. Doing so may damage the camera.
- HDMI output is not performed while connected via USB to a computer.
- When [4K] is selected, video output in shooting mode is [1080p].
- Turn the camera off before disconnecting the HDMI cable.

Using the TV remote control

The camera can be operated by a TV remote control when connected to a TV that supports HDMI control. Select [On] for [HDMI Control]. When [On] is selected, camera controls can be used for playback only.

- You can operate the camera by following the operation guide displayed on the TV.
- During single-frame playback, you can display or hide the information display by pressing the “Red” button, and display or hide the index display by pressing the “Green” button.
- Some televisions may not support all features.

Shutter speeds when the flash fires (⚡ X-Sync./⚡ Slow Limit)

MENU → ⚙ → **E** → [⚡ X-Sync.]/[⚡ Slow Limit]

You can set shutter speed conditions for when the flash fires.

Shooting mode	Flash firing shutter speed	Upper limit	Lower limit
P	The camera automatically sets the shutter speed.	[⚡ X-Sync.] setting*1	[⚡ Slow Limit] setting*2
A			
S	The set shutter speed		No lower limit
M			

*1 The upper limit is 1/200 seconds when using a separately sold external flash.

*2 Extends up to 60 seconds when slow synchronization is set.

Combinations of JPEG image sizes and compression rates

(⏪ Set)

MENU → ⚙ → **E** → [⏪ Set]

You can set the JPEG image quality by combining image size and compression rate.

Image size		Compression rate		
Name	Pixel Count	SF (Super Fine)	F (Fine)	N (Normal)
L (Large)	5184×3888	L SF	L F	L N
M (Middle)	3200×2400	M SF	M F	M N
S (Small)	1280×960	S SF	S F	S N

Use the camera's wireless LAN (Wi-Fi) and **Bluetooth®** features to connect to a smartphone, where you can use the dedicated app to enhance your enjoyment of the camera both before and after shooting. Once a connection has been established, you can download and take pictures remotely and add GPS tags to the images on the camera.

- Operation is not guaranteed on all smartphones.

Things you can do with the specified app, OLYMPUS Image Share (OI.Share)

- Download images from the camera to the smartphone
You can load images in the camera to a smartphone.
You can also use the smartphone to select images for download from the camera.
- Remote shooting from a smartphone
You can remotely operate the camera and shoot using a smartphone.
- Access information to help you enjoy your camera and photography.
You can easily access explanations of photographic techniques (Photo Guide), the Instruction Manual, and the photo-sharing community site even when on the go.

For details, visit the address below:

<https://app.olympus-imaging.com/oishare/>

Things you can do with the specified app, Olympus Image Palette (OI.Palette)

- Beautiful image processing
Use intuitive controls to apply impressive effects to images downloaded to your smartphone.

For details, visit the address below:

<https://app.olympus-imaging.com/oipalette/>

Things you can do with the specified app, OLYMPUS Image Track (OI.Track)

- Addition of GPS tags to camera images
You can add GPS tags to images simply by transferring the GPS log saved on the smartphone to the camera.

For details, visit the address below:



<https://app.olympus-imaging.com/oitrack/>

- Before using the wireless LAN function, read "Using the wireless LAN/**Bluetooth®** functions" (P. 194).
- Our company accepts no responsibility for violations of local regulations governing wireless communications caused by the use of the camera's wireless LAN/**Bluetooth®** features outside the country or region of purchase.
- As with any wireless communication, there is always a risk of interception by a third party.
- The wireless LAN function on the camera cannot be used to connect to a home or public access point.
- The transceiver antenna is located inside the grip. Keep the antenna away from metal objects whenever possible.
- Depending on the composition of the container or the objects it contains, the camera may be unable to connect to a smartphone when placed inside a bag or other container.
- During wireless LAN connection, the battery will run down faster. If the battery is running low, the connection may be lost during a transfer.
- Connection may be difficult or slow in proximity to devices that generate magnetic fields, static electricity or radio waves, such as near microwaves, cordless telephone.
- Wireless LAN can not be used when the memory card write-protect switch is in the "LOCK" position.



Pairing the Camera and Smartphone

Follow the steps below when connecting the devices for the first time.

- Adjust pairing settings using OI.Share, not the settings app that is part of the smartphone operating system.

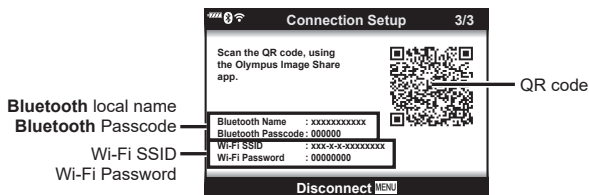
- 1 Launch the copy of the dedicated OI.Share app previously installed on your smartphone.
- 2 Select [Device Connection] in the  Playback Menu and press .
 - You can also connect by tapping  in the monitor.
- 3 Follow the on-screen guide to adjust **Wi-Fi/Bluetooth** settings.
 - The **Bluetooth** local name and passcode, the Wi-Fi SSID and password, and a QR code are displayed in the monitor.



- 4 Tap the camera icon at the bottom of the OI.Share display.
 - An [Easy Setup] tab will be displayed.
- 5 Follow the on-screen instructions in OI.Share to scan the QR code and adjust connection settings.
 - If you are unable to scan the QR code, follow the on-screen instructions in OI.Share to adjust settings manually.
 - Bluetooth:** To connect, select the local name and enter the passcode displayed in the camera monitor into the **Bluetooth** settings dialog in OI.Share.
 - Wi-Fi:** To connect, enter the SSID and password displayed on the camera monitor into the **Wi-Fi** settings dialog in OI.Share.
 -  **1** will be displayed when pairing is complete.
 - The **Bluetooth** icon indicates the status as follows:
 - : The camera is emitting wireless signal.
 - : Wireless connection has been established.
- 6 To end the Wi-Fi connection, press **MENU** on the camera or tap [Disconnect] on the monitor screen.
 - You can also turn the camera off and end the connection from OI.Share.
 - At default settings, **Bluetooth** connection is kept active even after Wi-Fi connection is terminated, allowing you to shoot remotely with a smartphone. To set the camera to also terminate **Bluetooth** connection when terminating Wi-Fi connection, set [Bluetooth] to [Off].

Wireless Connection Standby Setting for When the Camera Is On

You can choose whether the camera will be on standby for wireless connection with the smartphone when the power is on.

- 1 Highlight [Wi-Fi/Bluetooth Settings] in the \uparrow setup menu and press \triangleright .
- 2 Highlight [Bluetooth] and press \triangleright .
 - Complete the pairing of camera and smartphone beforehand. [Bluetooth] cannot be selected unless the pairing has been completed.
- 3 Highlight the desired option and press the OK button.

Off	The camera will not be on standby for wireless connection and wireless signal will not be emitted even when the power is on. For connection with a smartphone, start [Device Connection] in the ▶ playback menu of the camera (P. 156).
On Ⓜ	When the camera is on, it will emit wireless signal and be on standby for wireless connection. You can connect the camera and the smartphone through operation of OI.Share and shoot remotely or transfer images.

- Because the [Bluetooth] setting also serves as an indicator of **Bluetooth**[®] connection status of the camera, [Stopped] and [Running] may be displayed besides the setting options [Off] and [On Ⓜ].

Wireless Settings for When the Camera Is Off

You can choose whether the camera will maintain a wireless connection to the smartphone when off.

- 1 Highlight [Wi-Fi/Bluetooth Settings] in the Ψ setup menu and press \triangleright .
- 2 Highlight [Power-off Standby] and press \triangleright .
- 3 Highlight the desired option and press the \odot button.

Select	When you turn the camera off, you will be prompted to choose whether to maintain the wireless connection to the smartphone.
Off	Turning the camera off terminates the wireless connection to the smartphone.
On	When the camera is turned off, the connection to the smartphone remains active and the smartphone can still be used to download or view the pictures on the camera.

■ “Select”

When [Select] is chosen for [Power-off Standby], a confirmation dialog will be displayed before the camera turns off if all the following conditions are met:

- [On] is selected for [Wireless Functions]
- The camera is currently connected with a smartphone (P. 156)
- The memory card is correctly inserted

Yes	Turn the camera off but leave the wireless smartphone connection active.
No	Turn the camera off and terminate the wireless smartphone connection.

- If no operations are performed about a minute after the confirmation dialog is displayed, the camera will end the wireless connection to the smartphone and turn off automatically.
- The first time you turn the camera off after connecting to a smartphone (P. 156), you may be prompted to choose whether to hide the confirmation dialog in future. To keep the camera from displaying the confirmation dialog when turned off in future, select [Don't show this screen again].

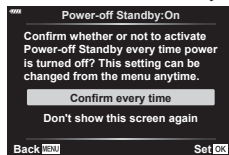
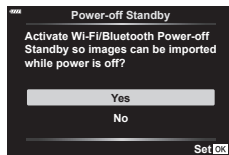





- If left active, the wireless connection will automatically terminate if:
 - the connection remains inactive for 12 hours
 - the memory card is removed
 - the battery is replaced
 - a charging error occurs during on-board battery chargingThe connection can be restored by turning the camera on.
- Note that if [On] is selected for [Power-off Standby], camera may not turn on immediately when the **ON/OFF** lever is rotated to **ON**.

Transferring images to a smartphone

You can select images in the camera and load them to a smartphone. You can also use the camera to select images you want to share in advance.  "Selecting Pictures for Sharing (Share Order)" (P. 122)

- 1 Start [Device Connection] on the camera (P. 156).
 - You can also connect by tapping  in the monitor.
 - If you have previously connected to the smartphone, the camera will start the connection automatically.
 -  1 will be displayed when pairing is complete.

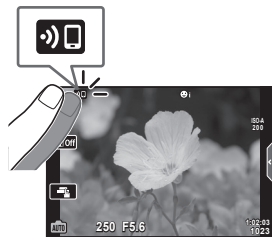

- 2 Tap [Import Photos] in OI.Share on the smartphone.
 - The images in the camera are displayed in a list.
- 3 Select the pictures you want to transfer and tap the Save button.
 - When saving is completed, you can turn off the camera from the smartphone.



- If the following options are selected for [Wi-Fi/Bluetooth settings] in the camera \Uparrow (setup) menu, you can download pictures to the smartphone as described in Steps 3 and 4, above, even when the camera is off:
 - [Wireless Functions]: [On]
 - [Power-off standby]: [On]

Automatically uploading images while the camera is off

To configure the camera to automatically upload images to a smartphone while off:

- Mark images for sharing (P. 122)
- Enable power-off standby (P. 158)
- If you are using an iOS device, launch OI.Share



- Auto upload is not available if you are connected via a router (for example, a home network), in which case you will need to transfer pictures using OI.Share.
- Some smartphones may terminate upload on entering sleep mode. Keep the smartphone awake while upload is in progress.

5

Automatically setting a share order for photographs

As soon as you shoot a picture, a share order will be set for it.

- 1 Highlight [Wi-Fi/Bluetooth Settings] in the setup menu and press .
- 2 Highlight [Auto Share Order] and press .
- 3 Highlight the desired option and press the button.

Off	Disables Auto Share Order for pictures you shoot.
On	Activates Auto Share Order for pictures you shoot.

- You can set a share order for 200 frames.
- (Auto Share Order icon) will be displayed on the monitor.
- The Auto Share Order icon indicates the status as follows:
 - : A share order will automatically be set for the pictures.
 - : A share order will not automatically be set for the pictures.
- Auto Share Order is applied only to JPEG images.
- You can cancel a share order automatically set for an image. Display the image for which you want to cancel the share order and press the () button.



Shooting remotely with a smartphone (Live View)

You can shoot remotely by operating the camera with a smartphone while checking the live view on the smartphone screen.

- The camera shows the connection screen and all operations are performed from the smartphone.
- 1** Start [Device Connection] on the camera (P. 156).
 - You can also connect by tapping  in the monitor.
 - 2** Launch OI.Share and tap [Remote Control].
 - 3** Tap [Live View].
 - 4** Tap the shutter button to shoot.
 - The image taken is saved on the memory card in the camera.
- Available shooting options are partially limited.



Shooting remotely with a smartphone (Remote Shutter)

You can shoot remotely by operating the camera with a smartphone (Remote Shutter).

- All operations are available on the camera. In addition, you can shoot pictures and record movies using the shutter button displayed on the smartphone screen.
 - If [Bluetooth] (P. 157) is set to [Off], set it to [On ].
 - If [Bluetooth] is set to [On ], the camera will be on standby for wireless connection as soon as it is turned on.
- 1** Launch OI.Share and tap [Remote Control].
 - 2** Tap [Remote Shutter].
 - 3** Tap the shutter button to shoot.
 - The image taken is saved on the memory card in the camera.
- The camera does not enter sleep mode while connected with a smartphone.
 - Even if [Bluetooth] is set to [Off], [Remote Shutter] can be used by starting [Device Connection] on the camera.





Adding position information to images

You can add GPS tags to images that were taken while the GPS log was saving by transferring the GPS log saved on the smartphone to the camera.

- 1 Before taking pictures with the camera, launch OI.Track on the smartphone to begin saving the GPS log.
 - Before starting a GPS track log, you will need to connect once via OI.Track and synchronize the clock.
 - You can use the phone or other apps while the GPS log is saving. Do not terminate OI.Track.
- 2 Once you have finished taking pictures with the camera, end tracking in OI.Share.
- 3 Tap the  icon in the camera monitor to connect to the smartphone.
 - You can also connect by selecting [Device Connection] in the  playback menu.
- 4 Upload the GPS log to the camera using OI.Track.
 - The GPS log will be used to add location data to any pictures taken after you launched OI.Track in Step 1.
 -  is displayed on images to which position information has been added.
 - Addition of location information can only be used with smartphones that have a GPS function.
 - Position information cannot be added to movies.





Resetting wireless LAN/Bluetooth® settings

To restore [Wi-Fi/Bluetooth Settings] to default values:

- 1 Select [Wi-Fi/Bluetooth Settings] in the  Setup Menu and press .
- 2 Select [Reset Settings] and press .
- 3 Select [Yes] and press the  button.
 - The following settings will be reset:
[Wireless Functions] (P. 163)/[Bluetooth] (P. 157)/[Connection Password] (P. 163)/
[Power-off Standby] (P. 158)/[Auto Share Order] (P. 160)
 - When you reset the settings, pairing with the smartphone will also be reset. To connect the camera to a smartphone, start [Device Connection] again (P. 156).





Changing the password

To change the Wi-Fi/**Bluetooth** passwords:



- 1 Select [Wi-Fi/Bluetooth Settings] in the  Setup Menu and press .
- 2 Select [Connection Password] and press .
- 3 Follow the operation guide and press the  button.
 - A new password will be set.
 - Both the Wi-Fi connection password and **Bluetooth**[®] connection passcode can be changed.
 - Reconnect to the smartphone after changing passwords.  "Pairing the Camera and Smartphone" (P. 156)

Disabling wireless LAN/Bluetooth[®]

To disable wireless LAN/**Bluetooth**[®]:

- 1 Select [Wi-Fi/Bluetooth Settings] in the  Setup Menu and press .
- 2 Select [Wireless Functions] and press .
- 3 Select [Off] and press the  button.
 - The following functions will be disabled.
[Device Connection] (P. 156)/[Power-off Standby] (P. 158)/[Bluetooth] (P. 157)



- To disable wireless LAN/**Bluetooth**[®] only while the camera is off, select [Off] for [Wi-Fi/Bluetooth Settings] > [Power-off Standby].  "Wireless Settings for When the Camera Is Off" (P. 158)
- To disable wireless connection standby only while the camera is on and stop the emission of wireless signal, select [Off] for [Wi-Fi/Bluetooth Settings] > [Bluetooth].  "Wireless Connection Standby Setting for When the Camera Is On" (P. 157)

6

Connecting the camera to a computer

Copying pictures to a computer

- 1 Turn the camera off and connect it to the computer.

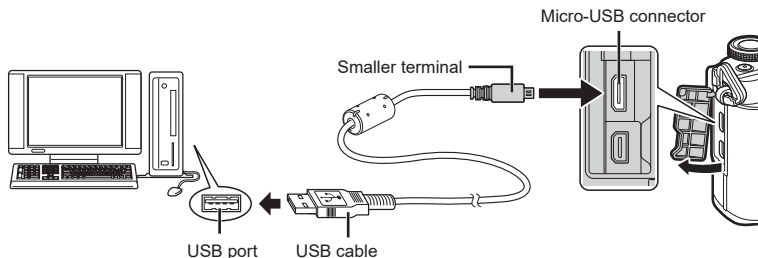

- The location of the USB port varies with the computer. For details, refer to your computer's manual.

- 2 Turn the camera on.

- The selection screen for the USB connection is displayed.
- When the camera is connected to a computer via USB, a dialog should be displayed in the monitor prompting you to choose a host. If it is not, select [Auto] for [USB Mode] (P. 146) in the camera custom menus.
- If nothing is displayed on the camera screen even after connecting the camera to the computer, the battery may be exhausted. Use a full-charged battery.

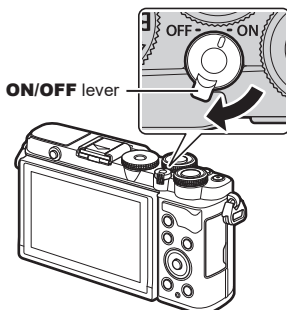

- 3 Press Δ ∇ to select [Storage]. Press the \odot button.

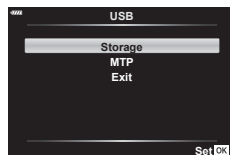

4 The computer recognizes the camera as a new device.

- Data transfer is not guaranteed in the following environments, even if your computer is equipped with a USB port.
 - Computers with a USB port added by means of an extension card, etc., computers without a factory-installed OS, or home-built computers
- Camera controls cannot be used while the camera is connected to a computer.

Installing the PC software

Install the following software to access the camera while it is connected directly to the computer via USB.

Olympus Workspace

This computer application is used to download and view photos and movies recorded with the camera. It can also be used to update the camera firmware. The software can be downloaded from the website below. Be prepared to provide the camera serial number when downloading the software.

<https://support.olympus-imaging.com/owdownload/>

Batteries

- The camera uses our lithium-ion battery. Never use any battery other than our genuine batteries.
- The camera's power consumption varies widely with usage and other conditions.
- As the following consume a lot of power even without shooting, the battery will be drained quickly.
 - Performing auto focus repeatedly by pressing the shutter button halfway in shooting mode.
 - Displaying images on the monitor for a prolonged period.
 - When connected to a computer.
 - Leaving wireless LAN/**Bluetooth**® enabled.
- When using a drained battery, the camera may turn off without the low battery warning being displayed.
- Remove the batteries before putting the camera into storage for periods of a month or more.

Leaving the batteries in the camera for extended periods shortens their lives, potentially rendering them unusable.
- The battery will not be fully charged at the time of purchase. Charge the battery using the supplied USB-AC adapter before use.
- The normal charging time using the provided USB-AC adapter is approximately 4 hours (estimated).
- Do not use USB-AC adapters or chargers not specifically designated for use with batteries of the supplied type. Similarly, do not use the supplied USB-AC adapter with batteries (cameras) other than those of the designated type.
- There is a risk of explosion if the battery is replaced with the incorrect battery type.
- Dispose of the used battery following the instructions "CAUTION" (P. 193) in the instruction manual.

Using your USB-AC adapter abroad

- The USB-AC adapter can be used in most home electrical sources within the range of 100V to 240V AC (50/60Hz) around the world. However, depending on the country or area you are in, the AC wall outlet may be shaped differently and the USB-AC adapter may require a plug adapter to match the wall outlet.
- Do not use commercially available travel adapters as the USB-AC adapter may malfunction.

Usable cards

In this manual, all storage devices are referred to as “cards.” The following types of SD memory card (commercially available) can be used with this camera: SD, SDHC, and SDXC. For the latest information, please visit our website.



SD card write protect switch

The SD card body has a write protect switch. Setting the switch to “LOCK” prevents data being written to the card. Return the switch to the unlock position enable writing.

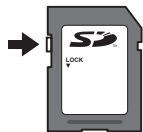

- Cards must be formatted with this camera before first use or after being used with other cameras or computers. “Formatting the card (Card Setup)” (P. 144)
- The data in the card will not be erased completely even after formatting the card or deleting the data. When discarding, destroy the card to prevent leakage of personal information.
- Access to some playback functions and the like may be restricted when the write-protect switch is in the “LOCK” position.

Interchangeable lenses

Choose a lens according to the scene and your creative intent. Use lenses designed exclusively for the Micro Four Thirds system and bearing the M.ZUIKO DIGITAL label or the symbol shown at right. With an adapter, you can also use Four Thirds System and OM System lenses. The optional adapter is required.



- When you attach or remove the body cap and lens from the camera, keep the lens mount on the camera pointed downward. This helps prevent dust and other foreign matter from getting inside the camera.
- Do not remove the body cap or attach the lens in dusty places.
- Do not point the lens attached to the camera toward the sun. This may cause the camera to malfunction or even ignite due to the magnifying effect of sunlight focusing through the lens.
- Be careful not to lose the body cap and rear cap.
- Attach the body cap to the camera to prevent dust from getting inside when no lens is attached.

■ Lens and camera combinations

Lens	Camera	Attachment	AF	Metering
Micro Four Thirds system lens	Micro Four Thirds system camera	Yes	Yes	Yes
Four Thirds system lens		Attachment possible with mount adapter	No*1	Yes
OM System lenses			No	Yes*2

*1 Only MF (manual focus) is available.

*2 Accurate metering is not possible.

MF Clutch Lenses

The “MF clutch” (manual focus clutch) mechanism on MF clutch lenses can be used to switch between auto and manual focus simply by repositioning the focus ring.

- Check the position of the MF clutch before shooting.
- Sliding the focus ring to the AF/MF position at the end of the lens selects autofocus, while sliding it to the MF position closer to the camera body selects manual focus, regardless of the focus mode chosen with the camera.

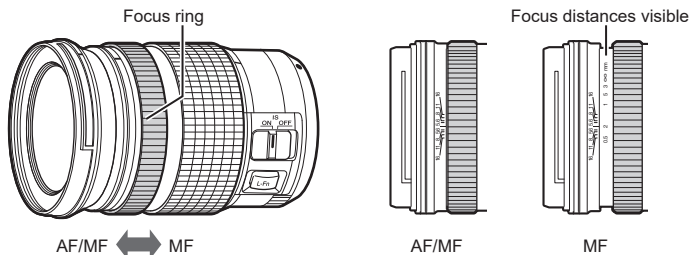

- Selecting [MF] for focus mode on the camera disables autofocus even when the focus ring is in the AF/MF position.

7

Cautions

Compatible Flash Units

Choose a flash unit to suit your needs, taking into consideration such factors as the output required and whether the unit supports macro photography. Flash units designed to communicate with the camera support a variety of flash modes, including TTL auto and super FP. See the documentation provided with the flash unit for information on flash features and their use. The camera also supports the following wireless flash control systems:

Radio-Controlled Flash Photography: CMD, ⚡CMD, RCV, and X-RCV Modes

The camera controls one or more remote flash units by means of radio signals. The range of locations in which flash units can be placed increases. Flash units can control other compatible units or be fitted with radio commander/receivers to allow the use of units that do not otherwise support radio flash control.

Wireless Remote-Control Flash Photography: RC Mode

The camera controls one or more remote flash units by means of optical signals. The flash mode can be selected using camera controls (P. 84).

■ Features Available with Compatible Flash Units



Flash unit	Supported flash control modes	GN (Guide Number, ISO 100)	Supported wireless systems
FL-700WR	TTL-AUTO, MANUAL, FP TTL AUTO, FP MANUAL, MULTI, RC, SL MANUAL	GN 42 (75/150 mm ^{*1}) GN 21 (12/24 mm ^{*1})	CMD, ⚡CMD, RCV, X-RCV, RC
FL-900R	TTL-AUTO, AUTO, MANUAL, FP TTL AUTO, FP MANUAL, MULTI, RC, SL AUTO, SL MANUAL	GN 58 (100/200 mm ^{*1}) GN 27 (12/24 mm ^{*1})	RC
STF-8	TTL-AUTO, MANUAL, RC ^{*2}	GN 8.5	RC ^{*2}

*1 Maximum lens focal length at which unit can provide flash coverage (figures following slashes are 35 mm format equivalent focal lengths).

*2 Functions as commander (transmitter) only.

Wireless remote control flash photography

External flash units that are designated for use with this camera and have a remote control mode can be used for wireless flash photography. The camera can separately control each of three groups of remote flash units, and the internal flash. See the instruction manuals provided with the external flash units for details.

- 1 Set the remote flash units to RC mode and place them as desired.
 - Turn the external flash units on, press the MODE button, and select RC mode.
 - Select a channel and group for each external flash unit.
- 2 Select [On] for [⚡ RC Mode] in  Shooting Menu 2 (P. 129).
 - Press the  button to exit to the RC mode display. Press the **INFO** button to cycle between LV super controls or live controls and the RC mode display.
 - Select a flash mode (note that red-eye reduction is not available in RC mode).
- 3 Adjust the settings for each group in the RC mode display.

Group

• Select the flash control mode and adjust the flash intensity separately for each group. For MANUAL, select the flash intensity.

Adjust settings for the camera flash unit.

Flash intensity value

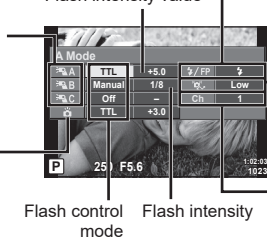

Normal flash/Super FP flash

• Switch between normal flash and Super FP flash.

Communication light level

• Set the communication light level to [HI], [MID], or [LO].

Channel

• Set the communication channel to the same channel used on the flash.

- 4 Press the flash pop-up button to raise the flash.
 - After confirming that the flash has charged, take a test shot.

■ Wireless flash control range

Position the wireless flash units with their remote sensors facing the camera. The following illustration shows the approximate ranges at which the flash units can be positioned. The actual control range varies with local conditions.

- We recommend using a single group of up to three remote flash units.
- Remote flash units cannot be used for second curtain slow synchronization exposures longer than 4 seconds.
- If the subject is too close to the camera, the control flashes emitted by the camera flash may affect exposure (this effect can be reduced by reducing the output of the camera flash by, for example, using a diffuser).
- The upper limit of flash synchronization timing is 1/160 sec. when using the flash in RC mode.

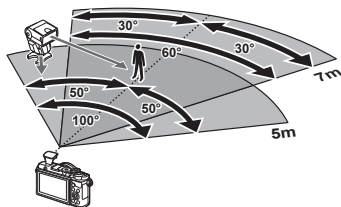

Other external flash units

Note the following when using a third-party flash unit mounted on the camera hot shoe:

- Using obsolete flash units that apply currents of more than about 24 V to the X-contact will damage the camera.
- Connecting flash units with signal contacts that do not conform to our specifications may damage the camera.
- Set the Shooting mode to **M**, set the shutter speed to a value no higher than flash synchronous speed, and set ISO sensitivity to a setting other than [AUTO].
- Flash control can only be performed by manually setting the flash to the ISO sensitivity and aperture values selected with the camera. Flash brightness can be adjusted by adjusting either ISO sensitivity or aperture.
- Use a flash with an angle of illumination suited to the lens. Angle of illumination is usually expressed using 35-mm format equivalent focal lengths.

System chart

Power Supply



BLS-50
Lithium-ion battery



F-5AC
USB-AC Adapter



BCS-5
Lithium-ion Charger

Dot Sight



EE-1
Dot Sight

E-P7

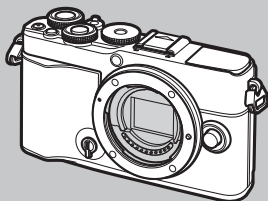

Case / Strap

Shoulder Strap /
Camera Case

Connection Cable

USB Cable
CB-USB12/
HDMI Cable*1

Memory Card

SD/SDHC/
SDXC

Software

Olympus Workspace
Photo editing software

OLYMPUS Image Share (OI.Share)
Olympus Image Palette (OI.Palette)
OLYMPUS Image Track (OI.Track)
Smartphone App

 : E-P7 compatible products

 : Commercially available products

For the latest information, please visit our website.

*1 HDMI cables are available from third-party suppliers.

*2 Not all lenses can be used with adapter. For details, refer to our website.

*3 For compatible lens, refer to our website.

Lens



Micro Four Thirds system lenses



MMF-2/MMF-3²
Four Thirds Adapter

Four Thirds System Lenses



BCL-1580/BCL-0980
Body Cap Lens

Converter Lens*3

FCON-P01
Fisheye

WCON-P01
Wide

MCON-P01
Macro

MCON-P02
Macro

MC-14
Teleconverter

MC-20
Teleconverter

Flash



FL-900R
Electronic Flash

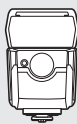

FL-700WR
Electronic Flash

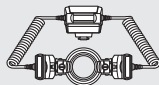

STF-8
Macro Flash

Radiowave System Accessories



FC-WR
Wireless radiowave
commander



FR-WR
Wireless radiowave receiver

Cleaning and storing the camera

Cleaning the camera

Turn off the camera and remove the battery before cleaning the camera.

- Do not use strong solvents such as benzene or alcohol, or a chemically treated cloth.

Exterior:

- Wipe gently with a soft cloth. If the camera is very dirty, soak the cloth in mild soapy water and wring well. Wipe the camera with the damp cloth and then dry it with a dry cloth. If you have used the camera at the beach, use a cloth soaked in clean water and well wrung.

Monitor:

- Wipe gently with a soft cloth.

Lens:

- Blow dust off the lens with a commercially available blower. For the lens, wipe gently with a lens cleaning paper.

Storage

- When not using the camera for a prolonged period, remove the battery and card. Store the camera in a cool, dry place that is well ventilated.
- Insert the battery periodically and test the camera's functions.
- Remove dust and other foreign matter from the body and rear caps before attaching them.
- Attach the body cap to the camera to prevent dust from getting inside when no lens is attached. Be sure to replace the front and rear lens caps before putting the lens away.
- Clean the camera after use.
- Do not store with insect repellent.
- Avoid storing the camera in places where chemicals are treated, in order to protect the camera from corrosion.
- Mold may form on the lens surface if the lens is left dirty.
- Check each part of the camera before use if it has not been used for a long time. Before taking important pictures, be sure to take a test shot and check that the camera works properly.

Cleaning and checking the image pickup device

This camera incorporates a dust reduction function to keep dust from getting on the image pickup device and to remove any dust or dirt from the image pickup device surface with ultrasonic vibrations. The dust reduction function operates when the camera is turned on.

The dust reduction function operates at the same time as the pixel mapping, which checks the image pickup device and image processing circuitry. Since dust reduction is activated every time the camera's power is turned on, the camera should be held upright for the dust reduction function to be effective.

Pixel Mapping - Checking the image processing functions

The pixel mapping feature allows the camera to check and adjust the image pickup device and image processing functions. Before using the pixel mapping function to ensure that it operates correctly, wait for 1 minute or longer immediately after shooting or playback.

- 1 In Custom Menu **1**, select [Pixel Mapping] (P. 150).
- 2 Press **▶**, then press the **OK** button.
 - The [Busy] bar is displayed when pixel mapping is in progress. When pixel mapping is finished, the menu is restored.
 - If you accidentally turn the camera off during pixel mapping, start again from Step 1.

Shooting tips and information

The camera does not turn on even when a battery is loaded

The battery is not fully charged

- Charge the battery with the USB-AC adapter.

The battery is temporarily unable to function because of the cold

- Battery performance drops at low temperatures. Remove the battery and warm it by putting it in your pocket for a while.

A language-selection prompt is displayed

The dialog shown in the illustration will be displayed in the following circumstances:

- The camera is turned on for the first time
- You previously ended initial setup without choosing a language

Choose a language as described in "Initial setup" (P. 23).

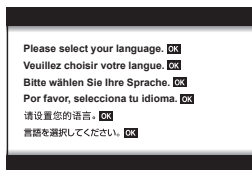

The date and time has not been set

The camera is used with the settings at the time of purchase

- The date and time of the camera is not set when purchased. Set the date and time before using the camera.  "Initial setup" (P. 23)

The battery has been removed from the camera

- The date and time settings will be returned to the factory default settings if the camera is left without the battery for approximately 1 day. The settings will be canceled more quickly if the battery was only loaded in the camera for a short time before being removed. Before taking important pictures, check that the date and time settings are correct.

Set functions are restored to their factory default settings

Options selected in **AUTO** () , **SCN**, or **VAP** mode are reset when the mode dial is rotated to another setting.

Functions that cannot be selected from menus

Some items may not be selectable from the menus when using Δ ∇ \langle \rangle .

- Items that cannot be set with the current shooting mode.
- Items that cannot be set because of an item that has already been set.
Combinations of [] (P. 86) and [Noise Reduct.] (P. 147), etc.

The number of AF targets is reduced

The size and number of the AF targets changes with the aspect ratio (P. 97), the AF target mode (P. 81), and the option selected for [Digital Tele-converter] (P. 130).

No picture is taken when the shutter button is pressed

The camera has turned off automatically

- The camera automatically enters sleep mode to reduce the drain on the battery if no operations are performed for a set period of time.  [Sleep] (P. 150)
Press the shutter button halfway to exit the sleep mode.
The camera will turn off automatically if no operations are performed for an additional 4 hours.

The flash is charging

- On the monitor, the  mark blinks when charging is in progress. Wait for the blinking to stop, then press the shutter button.

Unable to focus

- The camera cannot focus on subjects that are too close to the camera or that are not suited to autofocus (the AF confirmation mark will blink in the monitor). Increase the distance to the subject or focus on a high contrast object at the same distance from the camera as your main subject, compose the shot, and shoot.

Subjects that are difficult to focus on

It may be difficult to focus with auto focus in the following situations.

AF confirmation mark is blinking.
These subjects are not focused.



Subject with low contrast

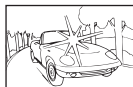

Excessively bright light in center of frame

AF confirmation mark lights up but the subject is not focused.



Subjects at different distances

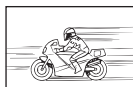

Fast-moving subject



Subject not inside AF area

Noise reduction is activated



- When shooting night scenes, shutter speeds are slower and noise tends to appear in images. The camera activates the noise-reduction process after shooting at slow shutter speeds. During which, shooting is not allowed. You can set [Noise Reduct.] to [Off].
 [Noise Reduct.] (P. 147)

Image taken appears whitish

This may occur when the picture is taken in backlight or semi-backlight conditions. This is due to a phenomenon called flare or ghosting. As far as possible, consider a composition where strong light source is not taken in the picture. Flare may occur even when a light source is not present in the picture. Use a lens hood to shade the lens from the light source. If a lens hood does not have effect, use your hand to shade the lens from the light.
 "Interchangeable lenses" (P. 167)

Unknown bright dot(s) appear on the subject in the picture taken

This may be due to stuck pixel(s) on the image pickup device. Perform [Pixel Mapping]. If the problem persists, repeat pixel mapping a few times.  "Pixel Mapping - Checking the image processing functions" (P. 175)

The subject appears distorted

The following functions use an electronic shutter:

movie recording (P. 74)/silent (P. 88)/the **SCN** mode panorama (P. 58), "silent" (P. 58), and "multi-focus shot" (P. 59) options/the **JAP** mode "silent" (P. 65), panorama (P. 66), and "focus bracketing" (P. 69) options

This may cause distortion if the subject is moving rapidly or the camera is moved abruptly. Avoid moving the camera abruptly during shooting or use standard sequential shooting.

Lines appear in photographs



The following functions use an electronic shutter, which may result in lines due to flicker and other phenomena associated with fluorescent and LED lighting, an effect that can sometimes be reduced by choosing slower shutter speeds:

movie recording (P. 74)/silent (P. 88)/the **SCN** mode panorama (P. 58), "silent" (P. 58), and "multi-focus shot" (P. 59) options/the **JAP** mode "silent" (P. 65), panorama (P. 66), and "focus bracketing" (P. 69) options

The camera is stuck in manual focus (MF) mode

Some lenses are equipped with a manual focus clutch that engages manual focus when the focus ring is slid back. Check the lens.  [MF Clutch Lenses] (P. 168)

Changing the number of frames or adding frames to the index playback display

Use the /Info Settings >  Settings] option in custom menu **C1** to change the number of frames shown in or add frames to the index playback display (P. 152).

Hiding menu guides

Press the **INFO** button to hide or show on-screen guides in the menu display (P. 128).











Viewing the functions assigned to dials and buttons



Use the options in Custom Menu **B** to view the functions assigned to camera controls. [Button Function] (P. 145)/ Function] (P. 145)/[Dial Function] (P. 145)

Movies do not play back smoothly when viewed on a TV

The movie frame rate may not match the video standard used in the TV. View the movie on a computer instead. Before recording movies for display on a TV, choose a frame rate that matches the video standard used in the device.  [Video Frame Rate] (P. 136)

Error codes

Monitor indication	Possible cause	Corrective action
 No Card	The card is not inserted, or it cannot be recognized.	Insert a card or insert a different card.
 Card Error	There is a problem with the card.	Insert the card again. If the problem persists, format the card. If the card cannot be formatted, it cannot be used.
 Write Protect	Writing to the card is prohibited.	The card write-protect switch is set to the "LOCK" side. Release the switch. (P. 167)
 Card Full	<ul style="list-style-type: none"> The card is full. No more pictures can be taken or no more information such as print reservation can be recorded. There is no space in the card and print reservation or new images cannot be recorded. 	Replace the card or erase unwanted pictures. Before erasing, download important images to a PC.
 No Picture	There are no pictures on the card.	The card contains no pictures. Record pictures and play back.
 Picture Error	The selected picture cannot be displayed for playback due to a problem with this picture. Or the picture cannot be used for playback on this camera.	Use image processing software to view the picture on a PC. If that cannot be done, the image file is damaged.
 The Image Cannot Be Edited	Pictures taken with another camera cannot be edited on this camera.	Use image processing software to edit the picture.
Y/M/D	The clock is not set.	Set the clock (P. 24).
 °C/°F		Turn off the camera and wait for the internal temperature to cool.
 Internal camera temperature is too high. Please wait for cooling before camera use.	The internal temperature of the camera has risen due to sequential shooting.	Wait a moment for the camera to turn off automatically. Allow the internal temperature of the camera to cool before resuming operations.
 Battery Empty	The battery is drained.	Charge the battery.

Monitor indication	Possible cause	Corrective action
 No Connection	The camera is not correctly connected to a computer, HDMI display, or other device.	Reconnect the camera.
 Cannot Print	It may not be possible to create print reservations for pictures recorded on other cameras via this camera.	Print separately via a personal computer, etc.
The lens is locked. Please extend the lens.	The lens of the retractable lens stays retracted.	Extend the lens.
Please check the status of a lens.	An abnormality has occurred between the camera and the lens.	Turn off the camera, check the connection with the lens, and turn the power on again.
This function requires a compatible lens. Please attach a compatible lens.	The lens does not support the selected shooting mode.	Choose a lens that does or choose a different shooting mode.

Defaults

*1: Default can be restored by selecting [Full] for [Reset].

*2: Default can be restored by selecting [Basic] for [Reset].

LV Controls/LV Super Control Panel

Shooting mode	Item	Default	*1	*2	
P/A/S/M/B	ISO	AUTO	✓	✓	83
	Flash Mode		✓	✓	84
		±0.0	✓	✓	103
	Manual Value	FULL (flash set to [MANUAL])	✓	✓	84
	Image Stabilizer	S-IS On	✓	✓	96
	Image Stabilizer	M-IS	✓	✓	96
	WB	AUTO ([On] selected for [Keep Warm Color])	✓	✓	94
	WB compensation A	±0	✓	—	96
	WB compensation G	±0	✓	—	
	Kelvin	5400K ([CWB] selected for [WB])	✓	—	94
	AF Area		✓	✓	81
	AF Mode	S-AF	✓	✓	92
	Face Priority	Face & Eye Priority On	✓	—	82
			✓	✓	86
	Metering		✓	✓	93
		L F	✓	✓	98
			✓	✓	99
	Picture Mode	Natural	✓	✓	103
	Sharpness	±0	✓	—	106
	Contrast	±0	✓	—	106
	Saturation	±0	✓	—	106
	Gradation	Gradation Normal	✓	—	108
	Effect	— ([i-Enhance] selected for [Picture Mode]: Standard)	✓	—	110
	Color Filter	— ([Monochrome] selected for [Picture Mode]: N:Normal)	✓	✓	108
	Monochrome Color	— ([Monochrome] selected for [Picture Mode]: N:Normal)	✓	✓	109
	Aspect	4:3	✓	✓	97
	Color Space	sRGB	✓	✓	110, 148
Highlight&Shadow Control	(±0)	✓	✓	111	

Shooting mode	Item	Default	*1	*2	
(movie)	Picture Mode	Natural	✓	✓	103
	ISO	[P], [A], or [S] selected for [Mode]: AUTO (fixed) [M] selected for [Mode]: 200	✓	✓	83
	WB	AUTO ([On] selected for [Keep Warm Color])	✓	✓	94
	AF Mode	C-AF	✓	✓	92
	Mode	P	✓	—	115
		L/F	✓	✓	98
RC mode	A group A	TTL	✓	✓	170
	B group B	Off	✓	✓	
	C group C	Off	✓	✓	
	camera flash	Off	✓	✓	
	Flash compensation	±0 (TTL, Auto)	✓	✓	
	Flash level	1/1 (Manual)	✓	✓	
	/FP	(Normal)	✓	✓	
	optical signal strength	Low	✓	✓	
	Channel	1	✓	✓	

8

Shooting Menu

Tab	Function	Default	*1	*2			
	Reset	Basic	—	—	129		
	Picture Mode	Natural	✓	✓	94, 130		
	Digital Tele-converter	Off	✓	✓	130		
	Metering		✓	✓	93		
	AF Illuminator	On	✓	✓	130		
	Image Stabilizer	S-IS On	✓	✓	96		
	Elec. Zoom Speed	Normal	✓	—	131		
		±0.0	✓	✓	103		
	Multiple Exposure	Number of Frames	Off	✓	✓	131	
		Auto Gain	Off	✓	✓		
		Overlay	Off	✓	✓		
	Intrvl. Sh./Time Lapse		Off	✓	✓	133	
	Anti-Shock[]/ Silent[]	Anti-Shock[]	[] 0 sec	✓	—	135	
		Silent[]	[] 0 sec	✓	—		
		Noise Reduction[]		Off	✓		—
		Silent[] Mode Settings		Not Allow	✓		—
AF Illuminator			Not Allow	✓	—		
Flash Mode		Not Allow	✓	—			
RC Mode		Off	✓	✓	135		

📺 Video Menu

Tab	Function	Default	*1	*2	👉
📺	Movie 🎤	On	✓	✓	136
	Recording Volume	±0	✓	—	136
	📺 AF Mode	C-AF	✓	✓	136
	📺 Image Stabilizer	M-IS 1	✓	✓	96
	📺 Elec. Zoom Speed	Normal	✓	—	136
	Video Frame Rate	30p	✓	—	99, 136
	Video Bit Rate	Fine	✓	—	99, 136

▶ Playback Menu

Tab	Function	Default	*1	*2	👉		
▶	📄	Start	—	—	—		
		BGM	On	✓	✓	120	
		Slide	All	✓	✓		
		Slide Interval	3 sec	✓	—		
		Movie Interval	Short	✓	—		
	📁	On	✓	✓	137		
	Edit	Sel. Image	RAW Data Edit	—	—	—	137
			JPEG Edit	—			139
			Movie Edit	—			141, 142
			🎤	—			124
	Image Overlay	—			141		
	Print Order	—	—	—	123		
	Reset Protect	—	—	—	142		
	Reset share Order	—	—	—	122		
	Device Connection	—	—	—	156		

⚙️ Custom Menu

Tab	Function	Default	*1	*2	👉		
⚙️	AF/MF						
	A	AEL/AFL	S-AF	mode1	✓	✓	145, 151
			C-AF	mode2			
			MF	mode1			
		☹️ Face Priority	☹️	✓	—	82, 145	
		MF Assist	Magnify	Off	✓	—	145,
			Peaking	Off	✓	—	151
	Reset Lens	On	✓	✓	145		

Tab	Function		Default	*1	*2		
	Button/Dial						
	B	Button Function	Function	AEL/AFL	✓	—	112, 145
			Function	⊙ REC	✓	—	
		⊙ Function		✓	—	145	
	Dial Function	P	Front dial:	Front dial:	✓	—	145
			Rear dial: Ps	Rear dial: Ps			
			Front dial:	Front dial:			
			Rear dial: FNo.	Rear dial: FNo.			
	A	Front dial:	Front dial:	✓	—	145	
		Rear dial: FNo.	Rear dial: FNo.				
	S	Front dial:	Front dial:	✓	—	145	
		Rear dial: Shutter	Rear dial: Shutter				
	M/B	Front dial: FNo.	Front dial: FNo.	✓	—	145	
		Rear dial: Shutter	Rear dial: Shutter				
	Disp.//PC						
C1	Control Settings	Auto	LV super control panel	✓	—	89, 146	
		P/A/S/M/B	LV super control panel	✓	—		
		ART	LV super control panel	✓	—		
		SCN/AP	LV super control panel	✓	—		
	/Info Settings	Info	Image Only, Overall	✓	✓	146, 152	
		LV-Info	Custom1 (), Custom2 (Level Gauge)	✓	—		
		Settings	25, Calendar	✓	—		
	Live View Boost		Off	✓	✓	146	
	Flicker Reduction		Auto	✓	—	146	
	Displayed Grid		Off	✓	—	146	
Peaking Color		Red	✓	—	146		
C2			On	✓	✓	146	
	HDMI	Output Size	1080p	✓	—	146,	
		HDMI Control	Off	✓	—	153	
	USB Mode		Auto	✓	✓	146	
Exp/ISO/BULB							
D1	Exposure Shift		±0	✓	—	147	
	ISO-Auto Set	Upper Limit	6400	✓	✓	147	
		Default	200	✓	✓		
	Noise Filter		Standard	✓	✓	147	
Noise Reduct.		Auto	✓	✓	43, 147		
D2	Bulb/Time Timer		8min	✓	✓	42, 147	
	Live Bulb		Off	✓	—	42, 147	
	Live Time		0.5 sec	✓	—	42, 147	
	Composite Settings		1 sec	✓	—	44, 147	

Tab	Function	Default	*1	*2		
	Custom					
	X-Sync.	1/250	✓	✓	148, 154	
	Slow Limit	1/60	✓	✓	148, 154	
	+	Off	✓	✓	81, 103, 148	
	+WB	WB AUTO	✓	—	148	
	/WB/Color					
	Set	-1 SF, -2 LF, -3 LN, -4 MN	✓	✓	148, 154	
	WB	AUTO	✓	✓	94, 148	
	AUTO Keep Warm Color	On	✓	✓	148	
	Color Space	sRGB	✓	✓	110, 148	
	Record					
	File Name	Reset	✓	—	149	
	Edit Filename	—	✓	—	149	
	Copyright Settings	Copyright Info.	Off	✓	—	149
		Artist Name	—	—	—	
Copyright Name		—	—	—		
Utility						
	Pixel Mapping	—	—	—	150, 175	
	Level Adjust	—	✓	—	150	
	Touchscreen Settings	On	✓	—	150	
	Sleep	1 min	✓	✓	22, 150	
	Certification	—	—	—	150	

Setup Menu

Tab	Function	Default	*1	*2		
	Card Setup	—	—	—	144	
		—	—	—	24	
		English	—	—	143, 144	
		±0, ±0, Vivid	✓	—	143	
	Rec View	0.5 sec	✓	—	143	
	Wi-Fi/Bluetooth Settings	Wireless Functions	On	✓	—	163
		Bluetooth	Off (Stopped)	✓	—	157
		Auto Share Order	Off	✓	—	160
		Power-off Standby	Select	✓	—	158
		Connection Password	—	—	—	163
	Reset Settings	—	—	—	162	
	Firmware	—	—	—	143	

Record mode and file size/number of storable still pictures

Memory Card Capacity: Photos

Figures are for a 16 GB SD card used to record photos with an aspect ratio of 4:3.

Record mode	Image size (Pixel Count)	Compression	File format	File size (MB)	Number of storable still pictures
RAW	5184×3888	Loss-less compression	ORF	17.4	867
L SF		1/2.7	JPEG	13.1	1054
L F		1/4		8.9	1549
L N		1/8		4.6	3013
M SF	3200×2400	1/2.7		5.1	2696
M F		1/4		3.6	3905
M N		1/8		1.9	7395
S SF	1280×960	1/2.7		1.0	13559
S F		1/4		0.8	18079
S N		1/8		0.5	28713

- The number of storable still pictures may change according to the subject, whether or not print reservations have been made, and other factors. In certain instances, the number of storable still pictures displayed on the monitor will not change even when you take pictures or erase stored images.
- The actual file size varies according to the subject.
- The maximum number of storable still pictures displayed on the monitor is 9999.

Memory Card Capacity: Movies

Figures are for a 32 GB SDHC memory card.

Frame size	Compression	Frame rate	Capacity (approx.)
4K	—	30p, 25p, 24p	39 minutes
FHD	SF	60p, 50p, 30p, 25p, 24p	1 hour 16 minutes
	F		2 hours 7 minutes
	N		3 hours 22 minutes
HD	SF	60p, 50p, 30p, 25p, 24p	2 hours 25 minutes
	F		4 hours 11 minutes
	N		5 hours 32 minutes

- Figures are for footage recorded at the maximum frame rate. The actual bit rate varies with the frame rate and scene recorded.
- Individual movie files can be up to 4 GB in size. A new file is created when the size of the current file reaches 4 GB.
- Individual movies can be no more than 29 minutes in length.

Specifications

■ Camera

Product type	
Product type	Digital camera with interchangeable Micro Four Thirds Standard lens system
Lens	M.Zuiko Digital, Micro Four Thirds System Lens
Lens mount	Micro Four Thirds mount
Equivalent focal length on a 35 mm film camera	Approx. twice the focal length of the lens
Image pickup device	
Product type	4/3" Live MOS sensor
Total no. of pixels	Approx. 21.77 million pixels
No. of effective pixels	Approx. 20.30 million pixels
Screen size	17.4 mm (H) × 13.0 mm (V)
Aspect ratio	1.33 (4:3)
Live view	
Sensor	Uses Live MOS sensor
Magnification	100%
Monitor	
Product type	3.0" TFT color LCD, Vari-angle, touch screen
Total no. of pixels	Approx. 1.04 million dots (aspect ratio 3:2)
Shutter	
Product type	Computerized focal-plane shutter
Shutter speed	1/4000 - 60 sec., bulb photography, time photography, live composite photography
Auto focus	
Product type	Hi-Speed Imager AF
Focusing points	121 points
Selection of focusing point	Auto, Optional
Exposure control	
Metering system	TTL metering system (imager metering) Digital ESP metering/Center weighted averaging metering/Spot metering
Metered range	EV -2 - 20 (f/2.8 lens, ISO100)
Shooting modes	P : Program AE (Program shift can be performed)/ A : Aperture priority AE/ S : Shutter priority AE/ M : Manual/ B : Bulb/Time/Live composite/ ☺ : AUTO/ SCN : Scene/ AP : Advanced Photo/ ART : Art Filter/ MOVIE : Movie
ISO sensitivity	LOW, 200 - 25600 (1/3 EV step)
Exposure compensation	±5.0 EV (1/3 EV step)
White balance	
Mode setting	Auto/Preset WB (6 settings)/Customized WB/One-touch WB (camera can store up to 4 settings)

Recording	
Memory	SD, SDHC and SDXC UHS-II compatible
Recording system	Digital recording, JPEG (DCF2.0), RAW Data
Applicable standards	Exif 2.31, Digital Print Order Format (DPOF)
Sound with still pictures	Wave format
Movie	MPEG-4 AVC/H.264
Audio	Stereo, PCM 48kHz
Playback	
Display format	Single-frame playback/Close-up playback/Index display/Calendar display
Drive	
Drive mode	Single-frame shooting/Sequential shooting/Self-timer/Silent shooting
Sequential shooting	Up to approximately 8.7 fps (☐) / Up to approximately 15 fps (♥☐)
Self-timer	Operation time: 12 sec./2 sec./Customized
Energy saving function	Switch to sleep mode: 1 minute (This function can be customized.) Power OFF: 4 hours
Flash	
Guide number	5.4 (ISO100•m)/7.6 (ISO200•m)
Firing angle	Covers the angle of view of a 14 mm lens (28 mm in 35 mm format)
Flash control mode	TTL-AUTO (TTL pre-flash mode)/MANUAL
Sync speed	1/250 s or slower
Wireless LAN	
Compatible standard	IEEE 802.11b/g/n
Bluetooth®	
Compatible standard	Bluetooth Version 4.2 BLE
External connector	
Micro-USB connector/HDMI micro connector (type D)	
Power supply	
Battery	Lithium-ion Battery ×1
Dimensions/weight	
Dimensions	118.3 mm (W) × 68.5 mm (H) × 38.1 mm (D) (4.7" × 2.7" × 1.5") (excluding protrusions)
Weight	Approx. 337 g (0.7 lb.) (including battery and memory card)
Operating environment	
Temperature	0 °C - 40 °C (32 °F - 104 °F) (operation)/ -20 °C - 60 °C (-4 °F - 140 °F) (storage)
Humidity	30% - 90% (operation)/10% - 90% (storage)

The terms HDMI and HDMI High-Definition Multimedia Interface, and the HDMI Logo are trademarks or registered trademarks of HDMI Licensing Administrator, Inc. in the United States and other countries.

HDMI™
HIGH-DEFINITION MULTIMEDIA INTERFACE

■ Lithium-ion battery

MODEL NO.	BLS-50
Product type	Rechargeable Lithium ion battery
Nominal voltage	DC 7.2 V
Nominal capacity	1210 mAh
No. of charge and discharge times	Approx. 500 times (varies with usage conditions)
Ambient temperature	0 °C - 40 °C (32 °F - 104 °F) (charging)
Dimensions	Approx. 35.5 mm (W) × 12.8 mm (H) × 55 mm (D) (1.4" × 0.5" × 2.2")
Weight	Approx. 46 g (0.1 lb.)

■ USB-AC adapter

MODEL NO.	F-5AC-1/F-5AC-2
Rated input	AC 100V - 240V (50/60Hz)
Rated output	DC 5 V, 1500 mA
Ambient temperature	0 °C - 40 °C (32 °F - 104 °F) (operation)/ -20 °C - 60 °C (-4 °F - 140 °F) (storage)

- SPECIFICATIONS ARE SUBJECT TO CHANGE WITHOUT ANY NOTICE OR OBLIGATION ON THE PART OF THE MANUFACTURER.
- Visit our website for the latest specifications.

SAFETY PRECAUTIONS

**CAUTION**

RISK OF ELECTRIC SHOCK
DO NOT OPEN



CAUTION: TO REDUCE THE RISK OF ELECTRICAL SHOCK, DO NOT REMOVE COVER (OR BACK). NO USER-SERVICEABLE PARTS INSIDE. REFER SERVICING TO OUR QUALIFIED SERVICE PERSONNEL.



An exclamation mark enclosed in a triangle alerts you to important operating and maintenance instructions in the documentation provided with the product.

**WARNING**

If the product is used without observing the information given under this symbol, serious injury or death may result.

**CAUTION**

If the product is used without observing the information given under this symbol, injury may result.

**NOTICE**

If the product is used without observing the information given under this symbol, damage to the equipment may result.

WARNING!

TO AVOID THE RISK OF FIRE OR ELECTRICAL SHOCK, NEVER DISASSEMBLE, EXPOSE THIS PRODUCT TO WATER OR OPERATE IN A HIGH HUMIDITY ENVIRONMENT.

General Precautions

Read All Instructions — Before you use the product, read all operating instructions. Save all manuals and documentation for future reference.

Power Source — Connect this product only to the power source described on the product label.

Foreign Objects — To avoid personal injury, never insert a metal object into the product.

Cleaning — Always unplug this product from the wall outlet before cleaning. Use only a damp cloth for cleaning. Never use any type of liquid or aerosol cleaner, or any type of organic solvent to clean this product.

Heat — Never use or store this product near any heat source such as a radiator, heat register, stove, or any type of equipment or appliance that generates heat, including stereo amplifiers.

Attachments — For your safety, and to avoid damaging the product, use only accessories recommended by our company.

Location — To avoid damage to the product, mount the product securely on a stable tripod, stand, or bracket.

**WARNING**

- Do not use the camera near flammable or explosive gases.
- Rest your eyes periodically when using the viewfinder.

Failure to observe this precaution could result in eyestrain, nausea, or sensations similar to motion sickness. The length and frequency of the required rest varies with the individual; use your own judgement. If you feel tired or unwell, avoid using the viewfinder and if necessary consult a physician.

- Do not use the flash and LED (including AF illuminator) on people (infants, small children, etc.) at close range.
 - You must be at least 1 m (3 ft.) away from the faces of your subjects. Firing the flash too close to the subject's eyes could cause a momentary loss of vision.
- Do not look at the sun or strong lights with the camera.

- **Keep young children and infants away from the camera.**
 - Always use and store the camera out of the reach of young children and infants to prevent the following dangerous situations which could cause serious injury:
 - Becoming entangled in the camera strap, causing strangulation.
 - Accidentally swallowing the battery, cards or other small parts.
 - Accidentally firing the flash into their own eyes or those of another child.
 - Accidentally being injured by the moving parts of the camera.
- **If you find that the USB-AC adapter is extremely hot or notice any unusual odors, noise, or smoke around it, unplug the power plug from wall outlet immediately and stop using it. Then, contact an authorized distributor or service center.**
- **Stop using the camera immediately if you notice any unusual odors, noise, or smoke around it.**
 - Never remove the batteries with bare hands, which may cause a fire or burn your hands.
- Never hold or operate the camera with wet hands. This may cause overheating, exploding, burning, electrical shocks, or malfunctions.
- **Do not leave the camera in places where it may be subject to extremely high temperatures.**
 - Doing so may cause parts to deteriorate and, in some circumstances, cause the camera to catch fire. Do not use the charger or USB-AC adapter if it is covered (such as a blanket). This could cause overheating, resulting in fire.
- **Handle the camera with care to avoid getting a low temperature burn.**
 - When the camera contains metal parts, overheating can result in a low-temperature burn. Pay attention to the following:
 - When used for a long period, the camera will get hot. If you hold on to the camera in this state, a low-temperature burn may be caused.
 - In places subject to extremely cold temperatures, the temperature of the camera's body may be lower than the environmental temperature. If possible, wear gloves when handling the camera in cold temperatures.
- To protect the high-precision technology contained in this product, never leave the camera in the places listed below, no matter if in use or storage:
 - Places where temperatures and/or humidity are high or go through extreme changes. Direct sunlight, beaches, locked cars, or near other heat sources (stove, radiator, etc.) or humidifiers.
 - In sandy or dusty environments.
 - Near flammable items or explosives.
 - In wet places, such as bathrooms or in the rain.
 - In places prone to strong vibrations.
- The camera uses a lithium ion battery specified by our company. Charge the battery with the specified USB-AC adapter or charger. Do not use any other USB-AC adapters or chargers.
- Never incinerate or heat batteries in microwaves, on hot plates, or in pressure vessels, etc.
- Never leave the camera on or near electromagnetic devices. This may cause overheating, burning, or exploding.
- Do not connect terminals with any metallic objects.
- Take precautions when carrying or storing batteries to prevent them from coming into contact with any metal objects such as jewelry, pins, fasteners, keys, etc. The short circuit may cause overheating, exploding, or burning, which burn or damage you.
- To prevent causing battery leaks or damaging their terminals, carefully follow all instructions regarding the use of batteries. Never attempt to disassemble a battery or modify it in any way, solder, etc.
- If battery fluid gets into your eyes, flush your eyes immediately with clear, cold running water and seek medical attention immediately.
- If you cannot remove the battery from the camera, contact an authorized distributor or service center. Do not try to remove the battery by force. Damage to the battery exterior (scratches, etc.) may produce heat or an explosion.
- Always store batteries out of the reach of small children and pets. If they accidentally swallow a battery, seek medical attention immediately.
- To prevent batteries from leaking, overheating, or causing a fire or explosion, use only batteries recommended for use with this product.

- If rechargeable batteries have not been recharged within the specified time, stop charging them and do not use them.
- Do not use batteries with scratches or damage to the casing, and do not scratch the battery.
- Never subject batteries to strong shocks or continuous vibration by dropping or hitting. This may cause exploding, overheating, or burning.
- If a battery leaks, has unusual odor, becomes discolored or deformed, or becomes abnormal in any other way during operation, stop using the camera, and keep away from fire immediately.
- If a battery leaks fluid onto your clothing or skin, remove the clothing and flush the affected area with clean, running cold water immediately. If the fluid burns your skin, seek medical attention immediately.
- Never use lithium-ion batteries in a low-temperature environment. Doing so may cause generation of heat, ignition, or explosion.
- Our lithium-ion battery is designed to be used only for our digital camera. Do not use the battery to other devices.
- **Do not allow children or animals/pets to handle or transport batteries (prevent dangerous behaviour such as licking, putting in mouth or chewing).**
- Never store batteries where they will be exposed to direct sunlight, or subjected to high temperatures in a hot vehicle, near a heat source, etc.
- Keep batteries dry at all times.
- The battery may become hot during prolonged use. To avoid minor burns, do not remove it immediately after using the camera.
- This camera uses our lithium-ion battery. Use the specified genuine battery. There is a risk of explosion if the battery is replaced with the incorrect battery type.
- Please recycle batteries to help save our planet's resources. When you throw away dead batteries, be sure to cover their terminals and always observe local laws and regulations.

NOTICE

- **Do not use or store the camera in dusty or humid places.**
- **Use SD/SDHC/SDXC memory cards only. Never use other types of cards.**
If you accidentally insert another type of card into the camera, contact an authorized distributor or service center. Do not try to remove the card by force.
- Regularly back up important data to a computer or other storage device to prevent accidental loss.
- Our company accepts no liability for any loss of data associated with this device.
- Be careful with the strap when you carry the camera. It could easily catch on stray objects and cause serious damage.
- Before transporting the camera, remove a tripod and all other accessories made by other companies.
- Never drop the camera or subject it to severe shocks or vibrations.
- When attaching the camera to or removing it from a tripod, rotate the tripod screw, not the camera.
- Do not touch electric contacts on cameras.
- Do not leave the camera pointed directly at the sun. This may cause lens or shutter curtain damage, color failure, ghosting on the image pickup device, or may possibly cause fires.
- Do not leave the viewfinder exposed to a strong light source or direct sunlight. The heat may damage the viewfinder.
- Do not push or pull severely on the lens.
- Be sure to remove any water droplets or other moisture from the product before replacing the battery or opening or closing covers.

Use Only Dedicated Rechargeable Battery, Battery Charger and USB-AC adapter

We strongly recommend that you use only the genuine rechargeable battery, battery charger, and USB-AC adapter specified by our company with this camera. Using a non-genuine rechargeable battery, battery charger and/or USB-AC adapter may result in fire or personal injury due to leakage, heating, ignition or damage to the battery. Our company does not assume any liability for accidents or damage that may result from the use of a battery, battery charger, and/or USB-AC adapter that are not specified genuine accessories.

CAUTION

- **Do not cover the flash with a hand while firing.**
- The included USB-AC adapter F-5AC is designed to be used only with this camera. Other cameras cannot be charged with this USB-AC adapter.
- Do not connect the included USB-AC adapter F-5AC to equipment other than this camera.

- Before storing the camera for a long period, remove the batteries. Select a cool, dry location for storage to prevent condensation or mold from forming inside the camera. After storage, test the camera by turning it on and pressing the shutter button to make sure that it is operating normally.
- The camera may malfunction if it is used in a location where it is subject to a magnetic/electromagnetic field, radio waves, or high voltage, such as near a TV set, microwave, video game, loud speakers, large monitor unit, TV/radio tower, or transmission towers. In such cases, turn the camera off and on again before further operation.
- Always observe the operating environment restrictions described in the camera's manual.
- Insert the battery carefully as described in the operating instructions.
- Before loading, always inspect the battery carefully for leaks, discoloration, warping, or any other abnormality.
- Always unload the battery from the camera before storing the camera for a long period.
- When storing the battery for a long period, select a cool location for storage.
- For plug-in type USB-AC adapter: Connect the plug-in type USB-AC adapter F-5AC correctly by plugging it vertically into the wall outlet.
- Power consumption by the camera varies depending on which functions are used.
- During the conditions described below, power is consumed continuously and the battery becomes exhausted quickly.
 - The zoom is used repeatedly.
 - The shutter button is pressed halfway repeatedly in shooting mode, activating the auto focus.
 - A picture is displayed on the monitor for an extended period of time.
- Using an exhausted battery may cause the camera to turn off without displaying the battery level warning.
- If the battery's terminals get wet or greasy, camera contact failure may result. Wipe the battery well with a dry cloth before use.
- Always charge a battery when using it for the first time, or if it has not been used for a long period.
- When operating the camera with battery power at low temperatures, try to keep the camera and spare battery as warm as possible. A battery that has run down at low temperatures may be restored after it is warmed at room temperature.
- Before going on a long trip, and especially before traveling abroad, purchase extra

batteries. A recommended battery may be difficult to obtain while traveling.

Using the wireless LAN/Bluetooth® functions

- **Turn off the camera in hospitals and other locations where medical equipment is present.**
The radio waves from the camera may adversely affect medical equipment, causing a malfunction that results in an accident. Be sure to disable wireless LAN/Bluetooth® functions in the vicinity of medical equipment (P. 163).
- **Turn off the camera when onboard aircraft.**
Using wireless devices onboard may hinder safe operation of the aircraft. Be sure to disable wireless LAN/Bluetooth® functions onboard aircraft (P. 163).

Monitor

- Do not push the monitor forcibly; otherwise the image may become vague, resulting in a playback mode failure or damage to the monitor.
- A strip of light may appear on the top/bottom of the monitor, but this is not a malfunction.
- When a subject is viewed diagonally in the camera, the edges may appear zigzagged on the monitor. This is not a malfunction; it will be less noticeable in playback mode.
- In places subject to low temperatures, the monitor may take a long time to turn on or its color may change temporarily.
When using the camera in extremely cold places, it is a good idea to occasionally place it in a warm place. The monitor exhibiting poor performance due to low temperatures will recover in normal temperatures.
- The monitor of this product is manufactured with high-quality accuracy, however, there may be a stuck or dead pixel on the monitor. These pixels do not have any influence on the image to be saved. Because of the characteristics, the unevenness of the color or brightness may also be found depending on the angle, but this is due to the structure of the monitor. This is not a malfunction.

Legal and Other Notices

- Our company makes no representations or warranties regarding any damages, or benefit expected by using this unit lawfully, or any request from a third person, which are caused by the inappropriate use of this product.
- Our company makes no representations or warranties regarding any damages or any benefit expected by using this unit lawfully which are caused by erasing picture data.

Disclaimer of Warranty

- Our company makes no representations or warranties, either expressed or implied, by or concerning any content of these written materials or software, and in no event shall be liable for any implied warranty of merchantability or fitness for any particular purpose or for any consequential, incidental or indirect damages (including but not limited to damages for loss of business profits, business interruption and loss of business information) arising from the use or inability to use these written materials or software or equipment. Some countries do not allow the exclusion or limitation of liability for consequential or incidental damages or of the implied warranty, so the above limitations may not apply to you.
- Our company reserves all rights to this manual.

Warning

Unauthorized photographing or use of copyrighted material may violate applicable copyright laws. Our company assumes no responsibility for unauthorized photographing, use or other acts that infringe upon the rights of copyright owners.

Copyright Notice

All rights reserved. No part of these written materials or this software may be reproduced or used in any form or by any means, electronic or mechanical, including photocopying and recording or the use of any type of information storage and retrieval system, without the prior written permission of our company. No liability is assumed with respect to the use of the information contained in these written materials or software, or for damages resulting from the use of the information contained therein. Our company reserves the right to alter the features and contents of this publication or software without obligation or advance notice.

Trademarks

- Microsoft and Windows are registered trademarks of Microsoft Corporation.
- SDXC Logo is a trademark of SD-3C, LLC.
- Apical logo is a registered trademark of Apical Limited.
- Micro Four Thirds, Four Thirds, and the Micro Four Thirds and Four Thirds logos are trademarks or registered trademarks of the OM Digital Solutions Corporation in Japan, the United States, the countries of the European Union, and other countries.
- Wi-Fi is a registered trademark of the Wi-Fi Alliance.



- The Wi-Fi CERTIFIED logo is a certification mark of the Wi-Fi Alliance.
- The **Bluetooth**® word mark and logos are registered trademarks owned by the Bluetooth SIG, Inc. and any use of such marks by OM Digital Solutions Corporation is under license.
- The standards for camera file systems referred to in this manual are the "Design Rule for Camera File System/DCF" standards stipulated by the Japan Electronics and Information Technology Industries Association (JEITA).
- All other company and product names are registered trademarks and/or trademarks of their respective owners.



THIS PRODUCT IS LICENSED UNDER THE AVC PATENT PORTFOLIO LICENSE FOR THE PERSONAL AND NONCOMMERCIAL USE OF A CONSUMER TO (i) ENCODE VIDEO IN COMPLIANCE WITH THE AVC STANDARD ("AVC VIDEO") AND/OR (ii) DECODE AVC VIDEO THAT WAS ENCODED BY A CONSUMER ENGAGED IN A PERSONAL AND NON-COMMERCIAL ACTIVITY AND/OR WAS OBTAINED FROM A VIDEO PROVIDER LICENSED TO PROVIDE AVC VIDEO. NO LICENSE IS GRANTED OR SHALL BE IMPLIED FOR ANY OTHER USE. ADDITIONAL INFORMATION MAY BE OBTAINED FROM MPEG LA, L.L.C. SEE [HTTP://WWW.MPEGLA.COM](http://www.mpegla.com)

The software in this camera may include third party software. Any third party software is subject to the terms and conditions, imposed by the owners or licensors of that software, under which software is provided to you.

Those terms and other third party software notices, if any, may be found in the software notice PDF file stored at <https://cs.olympus-imaging.jp/en/support/msgs/digicamera/download/notice/notice.cfm>

Symbols

	(Beep sound)	146
	Slow Limit.....	148, 154
	UP	84
	+WB	148
	X-Sync	148, 154
	RC Mode.....	170
	(Protect)	121
	(Monitor brightness adjustment)	143
	Mode (movie exposure mode)	115
	(Index display)	126, 152
	(Index display/Calendar display)	119
	/Info Settings	146, 152
	Settings	146
	(trimming)	139
	148
	(language).....	86
	(language).....	143
	(One-touch white balance)	95, 112
	(Single-frame erase)	121
	(Face priority AF)	82
	Keep Warm Color	148
	(Preview).....	112
	(Sequential Low)	86
	(Sequential High)	86
	Function	145
	Info	146
	Control Settings.....	146
	(Shortcut) Button.....	33
	(Movie) button	74, 112, 145
	(Image selection)	122
	(Close-up playback)	119
	(Image rotation).....	137

A

A (Aperture priority mode)	37
AdobeRGB	110
Advanced photo mode.....	60
AE Bracketing.....	68

AEL/AFL	151
AE lock	112, 113, 145, 151
AF illuminator.....	30, 130
AF Mode	92
Movie	136
AF target position	82
AF target settings	81
AF tracking	92
AP Mode	60
ART (Art filter).....	70
ART BKT.....	137
Aspect ratio.....	97
Audio recording	
Still image	124
AUTO mode ()	54
Auto Share Order	160

B

Backlight HDR	58
Battery charge	18
Battery level	22
Beep sound	146
Bleach Bypass.....	72
Bluetooth [®]	155
Bulb/Time	42
Bulb/Time Timer	147
Button Function	112

C

C-AF+TR (AF tracking).....	92
C-AF (Continuous AF)	92
Calendar display.....	119, 126, 152
Card.....	16, 167
Card Setup	144
Certification.....	150
Close-up playback.....	119
Color Creator	105
Color Filter	108
Color Profile Control	51
Color Space.....	110, 148
Composite Settings	147

Compression rate	98, 154, 186	Flash intensity control.....	103
Computer.....	164	Flicker Reduction.....	146
Connection		Focus Bracketing.....	69
Computer.....	164	Focus mode.....	92
Smartphone	155	Focus ring.....	92
Connection Password.....	163	Format.....	144
Continuous AF	92		
Contrast.....	106	G	
Control Settings.....	146	GPS log.....	162
Copyright Settings.....	149	Gradation.....	108
Custom Menu	145, 183		
		H	
D		HDMI	146, 153
Date/time setting (⌚).....	23	HDR.....	64
Dial Function.....	145	Highlight&Shadow Control.....	111
Digital Tele-converter.....	130	Histogram display	28
Displayed Grid.....	146		
DPOF.....	123	I	
		Image aspect.....	97
E		Image Overlay	141
Edit	137	Image quality	
Edit Filename.....	149	Movie (📹⏪).....	99
Effect (i-Enhance).....	110	Still image (📷⏪).....	98
Elec. Zoom Speed		Image quality settings	
Movie	136	Movie	99
Still image	131	Still image	98, 148, 186
Erase		Still image (⏪ Set).....	154
All images	144	Image size	
Selected images	122	Movie	99
Single-frame	121	Still image	148, 154, 186
Exif data.....	149	Image Stabilizer.....	96
Exposure compensation.....	81	Movie	136
Exposure Shift	147	Image transfer to smartphone	159
External flash units	169	Index display.....	119, 126, 152
Eye priority AF	82	INFO button.....	28, 117, 128
		Information display	26
F		Playback	116
Face priority AF	82	In-Movie Image Capture.....	141
File format.....	186	Installation	165
File Name	149	Instant Film.....	72
File size	186	Interchangeable lenses	167
Fine-Tune	73	ISO-Auto Set	147
Firmware.....	143	ISO sensitivity.....	83
Flash.....	84		

K

Keystone Compensation 67

L

Language setting () 143

Level Adjust 150

Level gauge 28

Light Trails 57

Live Bulb 42, 147

Live composite photography 44, 61

Live Time 42

LIVE TIME 42, 62

Live View Boost 146

Long time exposure (BULB/LIVE TIME)

..... 42

LV control 91, 181

LV-Info 146, 152

LV super control panel 89, 181

M

M (Manual mode) 41

Manual focus 92

Manual focus clutch (MF clutch) 168

Menu 128, 181

Metering 93

MF Assist 145, 151

MF (Button Function) 112

MF Clutch 168

MF (Manual focus) 92

Mode dial 29

Monitor brightness adjustment 143

Monochrome Color 109

Monochrome Profile Control 46

Movie  136

Movie exposure mode 115

Movie mode 76

Movie shooting 74

Movie Trimming 142

Multiple Exposure 63, 131

N

Noise Filter 147

Noise Reduct 147

Number of storable still pictures 186

O

OI.Palette 155

OI.Share 155

OI.Track 155

Olympus Workspace 2, 165

One-touch white balance () 95, 112

P

P (Program mode) 35

Panorama 66, 125

Partial Color 73

PC software 165

Peaking 113, 151

Peaking Color 146

Picture Mode 103, 130

Pixel Count 154, 186

Pixel mapping 150, 175

Playback

Movie 118, 121

Still image 118

Playback Menu 137, 183

Position information 162

Power-off Standby 158

Preview () 112

Profile Control 46

Profile control switch 46, 51

Program shift (Ps) 36

Protect 121

Ps (Program shift) 36

R

Radio-Controlled Flash Photography
..... 169

RAW Data Edit 137

RC Mode ( RC Mode) 170

Recording Volume 136

Rec View 143

Remote shooting 161

Reset 129

Reset Lens 145

Reset Protect 142

Reset share Order 122

Rotate 119

S

S (Shutter priority mode)	39
S-AF+MF (Single AF and Manual focus)	92
S-AF (Single AF).....	92
Saturation	106
SCN (Scene).....	56
SD card.....	167
Formatting the card.....	144
Self-portraits	78
Self-timer	86
Sequential shooting.....	86
Setup Menu	143, 185
Share Order	122
Sharpness	106
Shooting Menu	129, 182
Shooting Menu 1.....	129
Shooting Menu 2.....	129
Shooting modes.....	29
Silent[♥].....	58, 65, 88
Silent[♥] Mode Settings.....	135
Single AF	92
Sleep	22, 150
Slow-motion movie	77
sRGB.....	110
Storage	164
Super control panel	181
Super Spot AF	113

T

Time.....	42
Time Lapse Movie	133
Time lapse shooting	133
Touch screen operations	32, 126
Touchscreen Settings	150
TV	153

U

USB Mode	146
User registration	2

V

Video Bit Rate.....	99, 136
Video Frame Rate	99, 136
Video Menu	136, 183
Volume adjustment.....	121

W

WB.....	148
White balance.....	94
White balance compensation	96
Wi-Fi/Bluetooth Settings	143, 157, 158, 162, 163
Wireless Functions	158, 163
Wireless Remote Control Flash.....	170

Z

Zoom frame AF.....	113
--------------------	-----

date of issue 2021.04

OLYMPUS

OM Digital Solutions Corporation

<https://om-digitalsolutions.com/>