

OLYMPUS

DIGITAL CAMERA OLYMPUS PEN E-PL10 Instruction Manual

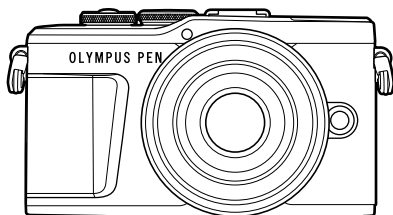

Table of Contents



Quick task index

- 1. Preparation**
- 2. Shooting**
- 3. Playback**
- 4. Menu functions**
- 5. Connecting the camera to a smartphone**
- 6. Connecting the camera to a computer**
- 7. Cautions**
- 8. Information**
- 9. SAFETY PRECAUTIONS**

Certification No.: IM008
Wi-Fi® Logo Certification No.: IM008Z

- Thank you for purchasing an Olympus digital camera. Before you start to use your new camera, please read these instructions carefully to enjoy optimum performance and a longer service life. Keep this manual in a safe place for future reference.
- We recommend that you take test shots to get accustomed to your camera before taking important photographs.
- The screen and camera illustrations shown in this manual were produced during the development stages and may differ from the actual product.
- If there are additions and/or modifications of functions due to firmware update for the camera, the contents will differ. For the latest information, please visit the Olympus website.

Table of Contents

| | | |
|--|-----------|--|
| Quick task index | 7 | |
| Names of parts | 12 | |
| Preparation | 14 | |
| Unpacking the box contents | 14 | |
| Charging and inserting the battery | 15 | |
| Inserting the card | 17 | |
| Removing the card | 17 | |
| Attaching a lens to the camera | 18 | |
| Turning the camera on | 20 | |
| Initial setup | 21 | |
| Camera displays unreadable/not in the selected language | 23 | |
| Shooting | 24 | |
| Information displays while shooting | 24 | |
| Switching the information display | 26 | |
| Choosing a shooting mode and taking photos | 27 | |
| Types of shooting modes | 27 | |
| Taking high angle and low angle shots | 29 | |
| Switching Displays with the  (Shortcut) Button | 30 | |
| Letting the camera choose the settings (AUTO mode) | 31 | |
| Shooting in scene mode (SCN mode) | 33 | |
| Types of scene modes | 33 | |
| Shooting in advanced photo mode (AP mode) | 37 | |
| AP Mode Options | 37 | |
| [Live Composite]: Live Composite Photography | 38 | |
| [Live Time]: Live Time Photography | 39 | |
| [Multiple Exposure]: Shooting Multiple Exposures | 40 | |
| [HDR]: Taking Composite Photos with HDR | 41 | |
| [Silent ] Mode | 42 | |
| Shooting a Panorama | 43 | |
| [Keystone Compensation] | 44 | |
| [AE Bracketing]: Varying Exposure over a Series of Shots | 45 | |
| [Focus Bracketing]: Varying Focus Distance over a Series of Shots | 46 | |
| Using art filters (ART mode) | 47 | |
| Types of art filters | 49 | |
| Adjusting the degree of the art filter effect (Fine-Tuning) | 50 | |
| Using [Partial Color] | 50 | |
| Letting the camera choose aperture and shutter speed (Program mode) | 51 | |
| Choosing aperture (Aperture Priority mode) | 52 | |
| Choosing shutter speed (Shutter Priority mode) | 53 | |
| Choosing aperture and shutter speed (Manual mode) | 54 | |

| | | | |
|---|----|---|----|
| ■ Shooting with long exposure time (BULB/LIVE TIME)..... | 55 | Performing the sequential/self-timer shooting | 74 |
| ■ Live composite photography (dark and light field composite)..... | 56 | The Electronic Shutter (Silent [♥]) | 75 |
| ■ Shooting with touch screen operations..... | 57 | Calling shooting options | 76 |
| ■ Recording movies in photo shooting modes..... | 58 | Processing options (Picture Mode)..... | 78 |
| ■ Recording movies in movie mode..... | 59 | Changing ISO sensitivity (ISO)..... | 79 |
| Movie Mode Options..... | 60 | Adjusting color (WB (white balance))..... | 80 |
| ■ Movie Effects | 61 | Choosing a focus mode (AF Mode)..... | 81 |
| ■ Creating Movies from Clips..... | 63 | Setting the image aspect..... | 83 |
| Recording Clips | 63 | Selecting image quality (Still image quality, ) | 83 |
| Creating new My Clips..... | 63 | Selecting image quality (Movie quality, ) | 84 |
| Removing a clip from My Clips..... | 64 | Adding effects to a movie | 87 |
| Editing "My Clips" | 64 | Adjusting flash output (Flash intensity control) | 88 |
| ■ Recording Slow Motion Movies | 66 | Reducing camera shake (Image Stabilizer) | 89 |
| ■ Using the silencing function when shooting a movie..... | 66 | Making fine adjustments to white balance (WB Compensation) | 90 |
| ■ Taking Photos in Self-Portrait Mode..... | 67 | Choosing how the camera measures brightness (Metering) | 91 |
| ■ Using various settings..... | 69 | Making fine adjustments to sharpness (Sharpness) | 91 |
| Controlling exposure (Exposure )..... | 69 | Making fine adjustments to contrast (Contrast)..... | 92 |
| Digital Zoom (Digital Tele-converter) | 69 | Making fine adjustments to saturation (Saturation)..... | 92 |
| Selecting the AF target mode (AF target settings)..... | 70 | Making fine adjustments to tone (Gradation) | 93 |
| Setting the AF target..... | 70 | | |
| Face priority AF/ Eye priority AF | 71 | | |
| Using a flash (Flash photography) | 72 | | |

| | |
|---|----|
| Applying filter effects to monochrome pictures (Color Filter)..... | 93 |
| Adjusting the tone of a monochrome image (Monochrome Color)..... | 94 |
| Adjusting i-Enhance effects (Effect)..... | 94 |
| Setting the color reproduction format (Color Space)..... | 95 |
| Changing the brightness of highlights and shadows (Highlight&Shadow Control)..... | 96 |
| Assigning functions to buttons (Button Function)..... | 97 |







Playback 100

| | |
|---|-----|
| ■ Information display during playback..... | 100 |
| Playback image information ... | 100 |
| Switching the information display | 101 |
| ■ Viewing photographs and movies..... | 102 |
| Index display/Calendar display | 103 |
| Viewing still images | 103 |
| Watching movies | 105 |
| Protecting images..... | 105 |
| Erasing an image..... | 105 |
| Setting a transfer order on images (Share Order)..... | 106 |
| Cancelling a share order | 106 |
| Selecting images (⏻, Erase Selected, Share Order Selected)..... | 106 |
| Creating a print order (DPOF)..... | 107 |
| Removing all or selected pictures from the print order ... | 108 |
| Audio recording | 108 |

| | |
|---|-----|
| Audio Playback..... | 108 |
| Viewing My Clips | 109 |
| Adding still pictures to My Clips..... | 109 |
| Removing clips from My Clips..... | 109 |
| Scrolling Panoramas | 110 |
| ■ Using the touch screen..... | 111 |
| Single-frame playback..... | 111 |
| Index/My Clips/Calendar playback..... | 111 |
| Selecting and protecting images | 112 |
| Viewing pictures in self-portrait mode..... | 112 |

Menu functions 113

| | |
|---|-----|
| ■ Basic menu operations..... | 113 |
| ■ Using Shooting Menu 1/ Shooting Menu 2 | 114 |
| Returning to default settings (Reset)..... | 114 |
| Processing options (Picture Mode)..... | 115 |
| Digital Zoom (Digital Tele-converter) | 115 |
| Improving Focus in Dark Surroundings (AF Illuminator)..... | 115 |
| Choosing a Zoom Speed (📷 Elec. Zoom Speed)..... | 116 |
| Shooting automatically with a fixed interval (Intrvl. Sh./Time Lapse) | 116 |
| Silent-Mode Options (Silent [🔇] Settings) | 117 |
| Wireless remote control flash photography (🔋 RC Mode)..... | 118 |

| | | | |
|--|-----|---|------------|
| ■ Using the Video Menu | 119 | Viewing camera images on TV | 134 |
| ■ Using the Playback Menu | 120 | Shutter speeds when the flash fires..... | 135 |
| Displaying images rotated ()..... | 120 | Combinations of JPEG image sizes and compression rates..... | 135 |
| Editing still images (Edit) | 120 | | |
| Saving a still image from a movie (In-Movie Image Capture)..... | 122 | | |
| Trimming movies (Movie Trimming)..... | 123 | | |
| Canceling all protections | 123 | | |
| ■ Using the setup menu | 124 | | |
| Formatting the card (Card Setup)..... | 125 | | |
| Deleting all images (Card Setup)..... | 125 | | |
| Choosing a language ()..... | 125 | | |
| ■ Using the custom menus | 126 | | |
| A AF/MF..... | 126 | | |
| B Button/Dial..... | 126 | | |
| C1 Disp/  /PC | 127 | | |
| C2 Disp/  /PC | 127 | | |
| D1 Exp/ISO/BULB | 128 | | |
| D2 Exp/ISO/BULB | 128 | | |
| E  Custom | 129 | | |
| F  /WB/Color | 129 | | |
| G Record..... | 130 | | |
| H  Utility | 131 | | |
| AEL/AFL | 131 | | |
| MF Assist..... | 132 | | |
| Adding information displays.... | 132 | | |
| | | Connecting the camera to a smartphone | 136 |
| | | ■ Pairing the Camera and Smartphone | 137 |
| | | ■ Wireless Settings for When the Camera Is Off | 138 |
| | | ■ Transferring images to a smartphone | 140 |
| | | ■ Automatically uploading images while the camera is off | 140 |
| | | ■ Shooting remotely with a smartphone | 141 |
| | | ■ Adding position information to images | 141 |
| | | ■ Resetting wireless LAN/Bluetooth® settings | 142 |
| | | ■ Changing the password | 142 |
| | | ■ Disabling wireless LAN/Bluetooth® | 143 |

Connecting the camera to a computer 144

- Connecting the camera to a computer 144
- Copying pictures to a computer 144
- Installing the PC software 145
- User Registration 145

Cautions 146

- Battery and charger 146
- Using your charger abroad 146
- Usable cards 147
- Record mode and file size/ number of storable still pictures 147
- Interchangeable lenses 148
- Compatible Flash Units 149
 - Wireless remote control flash photography 150
- Other external flash units 151
- System chart 152
- Cleaning and storing the camera 154
 - Cleaning the camera 154
 - Storage 154
 - Cleaning and checking the image pickup device 154
 - Pixel Mapping - Checking the image processing functions 155

Information 156

- Shooting tips and information 156
- Error codes 160
- Defaults 162
- Specifications 166

SAFETY PRECAUTIONS 169

- SAFETY PRECAUTIONS 169

Index 174

Quick task index

Shooting



| | | |
|--|--|----|
| Just shoot without making any difficult settings | ▶ AUTO mode (AUTO) | 31 |
| Shooting in the way you want without needing to know technical terms | ▶ Live Guide | 31 |
| Taking self-portraits | ▶ Self-portraits | 67 |
| Taking stylish pictures | ▶ Art filter | 47 |
| Quickly matching settings to the scene | ▶ Scene mode (SCN) | 33 |
| Taking pictures with a blurred background | ▶ Live Guide | 31 |
| | ▶ Aperture priority shooting | 52 |
| | ▶ Portrait + Nightscape (SCN) | 33 |
| Shooting night views | ▶ Nightscape (SCN) | 34 |
| | ▶ Hand-Held Starlight (SCN) | 34 |
| | ▶ Fireworks (SCN) | 34 |
| | ▶ Live Time (LAP) | 39 |
| Photographing fireworks | ▶ Live Composite (LAP) | 38 |
| | ▶ Live Composite (M) | 56 |
| | ▶ Bulb/time photography (M) | 55 |
| | ▶ Light Trails (SCN) | 34 |
| Photographing light trails | ▶ Live Time (LAP) | 39 |
| | ▶ Live Composite (LAP) | 38 |
| | ▶ Live Composite (M) | 56 |
| | ▶ Bulb/time photography (M) | 55 |
| Adjusting the brightness of highlights and shadows | ▶ Live Guide | 31 |
| | ▶ Exposure compensation | 69 |
| Taking photos with the flash | ▶ Flash photography | 72 |
| Taking photos without the flash | ▶ ISO sensitivity | 79 |
| Reducing camera shake | ▶ Image Stabilizer | 89 |
| | ▶ Self-timer | 74 |

| | | |
|---|-----------------------------------|-----|
| Taking pictures of a subject against backlight | ▶ Flash photography | 72 |
| | ▶ Backlight HDR (SCN) | 35 |
| | ▶ Gradation (Picture Mode) | 93 |
| | ▶ Spot metering | 91 |
| Using the self-timer | ▶ Self-timer | 74 |
| Sequential shooting | ▶ Sequential shooting | 74 |
| Changing an aspect ratio | ▶ Aspect ratio | 83 |
| Changing photo coloring | ▶ Live Guide | 31 |
| | ▶ Picture Mode | 78 |
| | ▶ White balance | 80 |
| Processing pictures to match the subject/Taking monotone pictures | ▶ Picture Mode | 78 |
| | ▶ Art filter (ART) | 47 |
| Taking pictures that stop the subject in motion or convey a sense of motion | ▶ Live Guide | 31 |
| | ▶ Scene mode (SCN) | 33 |
| | ▶ Shutter priority shooting | 53 |
| | ▶ Tap AF (Using the touch screen) | 57 |
| When the camera will not focus on your subject/Focusing on one area | ▶ AF target settings | 70 |
| | ▶ Zoom frame AF/zoom AF | 99 |
| | ▶ Zoom frame AF/zoom AF | 99 |
| Focusing on a small spot in the frame/confirming focus before shooting | ▶ Zoom frame AF/zoom AF | 99 |
| Keeping a moving subject in focus | ▶ C-AF+TR (AF tracking) | 82 |
| Focusing on and shooting a moving subject | ▶ C-AF | 81 |
| Creating commercial-style movies | ▶ My Clips | 63 |
| Reducing image noise (mottling) | ▶ Noise Reduct. | 128 |
| Optimizing the monitor/adjusting monitor hue | ▶ Monitor brightness adjustment | 124 |
| | ▶ Live View Boost | 127 |
| Checking horizontal or vertical orientation before shooting | ▶ Level gauge | 26 |
| Shooting with deliberate composition | ▶ Displayed Grid | 127 |
| Conserving battery power | ▶ Sleep | 131 |

| | | |
|---|---------------------------------------|-----|
| Increasing the number of pictures that can be taken | ▶ Still image quality mode | 83 |
| Using a remote control | ▶ Shooting remotely with a smartphone | 141 |
| | Silent [▼] (SCN) | 35 |
| Shooting without the shutter sound | ▶ Silent [▼] (AP) | 42 |
| | Silent [▼] (P/A/S/M/ART) | 75 |
| | ▶ Digital Tele-converter | 69 |
| Zooming in so your subject fills more of the frame | ▶ One-Touch e-Portrait | 67 |
| Improving complexions | ▶ Portrait (Picture Mode) | 78 |
| | ▶ e-Portrait (Picture Mode) | 78 |
| | ▶ Scene mode (SCN) | 33 |

Playback/Retouch



| | | |
|--|--|-----|
| Viewing images on a TV | ▶ HDMI | 127 |
| | ▶ Playback on TV | 134 |
| Viewing slideshows with background music | ▶ Slideshow | 104 |
| Brightening shadows | ▶ Shadow Adj (JPEG Edit) | 121 |
| Dealing with red-eye | ▶ Redeye Fix (JPEG Edit) | 121 |
| Printing made easy | ▶ Creating a print order | 147 |
| Viewing pictures on a smartphone | ▶ Transferring images to a smartphone | 140 |
| Uploading pictures to a smartphone automatically | ▶ Automatically uploading images while the camera is off | 140 |
| Adding location data to images | ▶ Adding location data to images | 141 |





Camera Settings



| | | |
|------------------------------------|-----------------------------|-----|
| Synchronizing the date and time | ▶ Setting the date/time | 21 |
| Restoring default settings | ▶ Reset | 114 |
| Changing the menu display language | ▶ | 125 |
| Turning off the auto focus sound | ▶ (Beep sound) | 127 |
| | ▶ Silent [▼] (SCN) | 35 |
| | ▶ Silent [▼] (AP) | 42 |

Indications used in this manual

The following symbols are used throughout this manual.

| | |
|--|---|
|  | Symbols designating the buttons (respectively the up, down, left, and right arrow buttons) to press on the arrow pad (P. 13). |
|  Notes | Points to note when using the camera. |
|  Tips | Useful information and hints that will help you get the most out of your camera. |
|  | Reference pages describing details or related information. |

Olympus will not be held liable for violations of local regulations arising from use of this product outside the country or region of purchase.

- Use of these features outside the country or region of purchase may violate local wireless regulations; be sure to check with local authorities before use. Olympus will not be held liable for the user's failure to comply with local regulations.

Names of parts

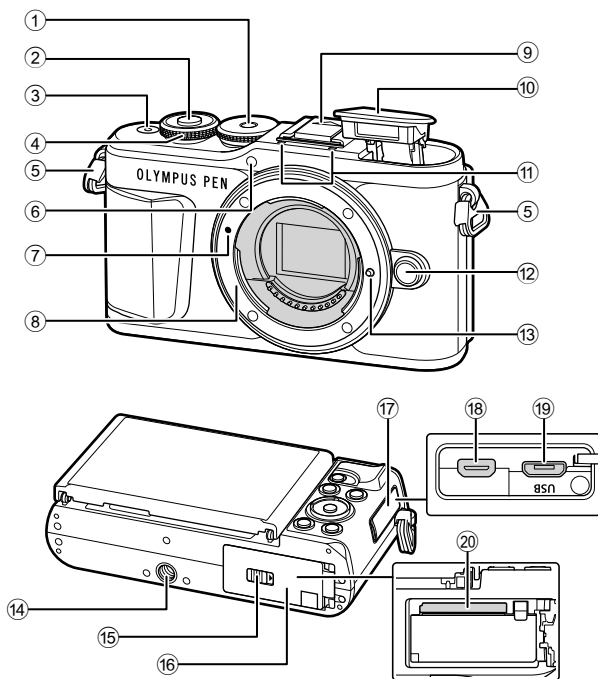

- | | |
|---|--|
| ① Mode dialP. 27 | ⑪ Stereo microphoneP. 108, 119, 121 |
| ② Shutter buttonP. 28 | ⑫ Lens release buttonP. 19 |
| ③ ON/OFF buttonP. 20 | ⑬ Lens lock pin |
| ④ Control dial (☺)P. 51–54, 69, 72, 102 | ⑭ Tripod socket |
| ⑤ Strap eyelet.....P. 14 | ⑮ Battery/card compartment lockP. 15, 17 |
| ⑥ Self-timer lamp/AF illuminatorP. 74/P. 115 | ⑯ Battery/card compartment coverP. 15, 17 |
| ⑦ Lens attachment markP. 18 | ⑰ Connector cover |
| ⑧ Mount (Remove the body cap before attaching the lens.) | ⑱ HDMI micro connectorP. 134 |
| ⑨ Hot shoe cover | ⑲ Micro-USB connector.....P. 144 |
| ⑩ Internal flashP. 72 | ⑳ Card slotP. 17 |

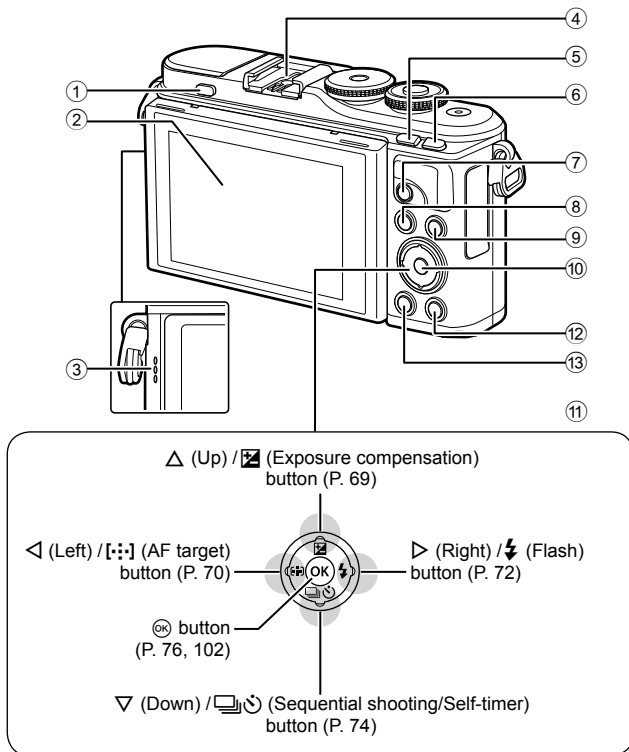

- | | |
|--|--|
| ① Flash pop-up button.....P. 72 | ⑧ MENU button.....P. 113 |
| ② Monitor (Touch screen)P. 24, 57, 76, 100, 111 | ⑨ INFO button.....P. 26, 101, 132 |
| ③ Speaker | ⑩ button.....P. 76, 102 |
| ④ Hot shoe.....P. 149 | ⑪ Arrow pad* (▲ ▼ ◀ ▶) |
| ⑤ (Shortcut)/ button.....P. 30/P. 103 | ⑫ (Playback) button.....P. 102 |
| ⑥ Fn/Q button.....P. 97/P. 69, 103 | ⑬ (Erase) button.....P. 105 |
| ⑦ (Movie)/ button.....P. 58/P. 106 | |

* In this manual, the ▲ ▼ ◀ ▶ icons represent operations performed using the arrow pad.

1 Preparation

Unpacking the box contents

The following items are included with the camera.
If anything is missing or damaged, contact the dealer from whom you purchased the camera.



Camera



Body cap



Strap

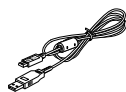

USB cable
CB-USB12



Lithium-ion battery
BLS-50

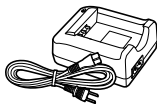

Lithium-ion charger
BCS-5

- Basic Manual
- Warranty card

Attaching the strap

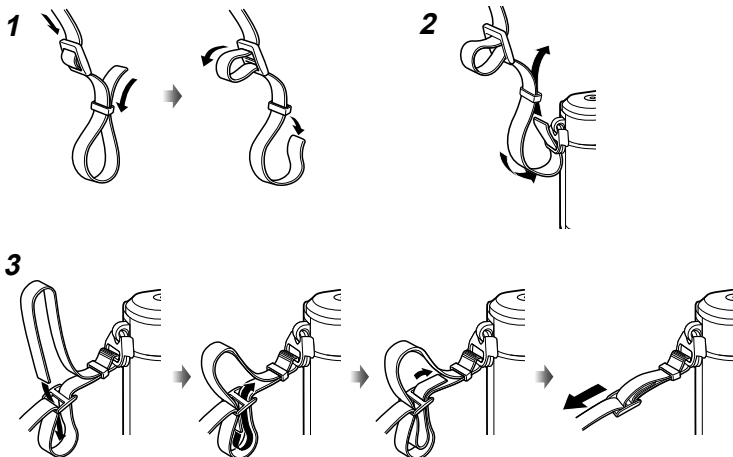

- Attach the strap on the other side in the same way.
- Lastly, pull the strap firmly, making sure that it is fastened securely.

Charging and inserting the battery

1 Charging the battery.

Charging indicator

| | |
|----------------------|---------------|
| Charging in progress | Lights orange |
| Charging complete | Off |
| Charging error | Blinks orange |

(Charging time: Up to approximately 3 hours 30 minutes)

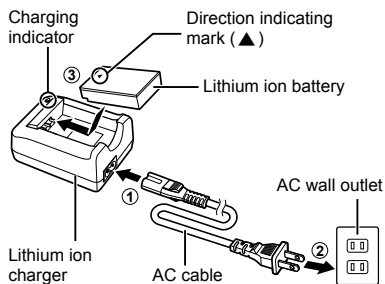

- Unplug the charger when charging is complete.

2 Opening the battery/card compartment cover.

Battery/card compartment cover

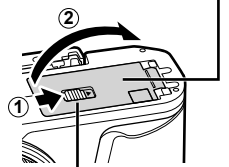

Battery/card compartment lock

3 Loading the battery.

- Use only BLS-50 batteries (P. 14, 168).

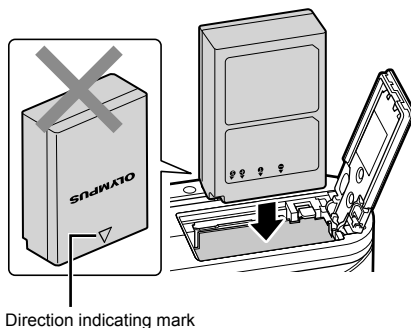

Removing the battery

Turn off the camera before opening or closing the battery/card compartment cover. To remove the battery, first push the battery lock knob in the direction of the arrow and then remove.

- Do not remove the battery while the card write indicator is displayed (P. 24).
- Contact an authorized distributor or service center if you are unable to remove the battery. Do not use force.

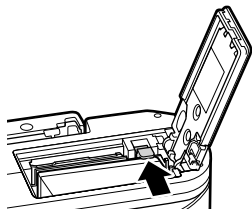

Notes

- It is recommended to set aside a backup battery for prolonged shooting in case the battery in use drains.
- The camera is not equipped with a built-in charger and cannot be recharged via a USB connection.
- Also read "Battery and charger" (P. 146).

Inserting the card

In this manual, all storage devices are referred to as “cards.”

The camera uses third-party SD, SDHC, or SDXC memory cards conforming to the SD (Secure Digital) standard.

Cards must be formatted with this camera before first use or after being used with other cameras or computers. 📖 “Formatting the card (Card Setup)” (P. 125)

1 Loading the card.

- Open the battery/card compartment cover.
- Slide the card in until it is locked into place.
📖 “Usable cards” (P. 147)

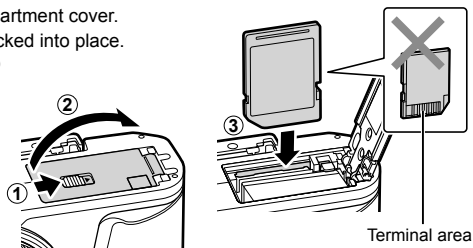

- Turn off the camera before loading or removing the battery or card.
- Do not forcibly insert a damaged or deformed card. Doing so may damage the card slot.

2 Closing the battery/card compartment cover.

- Be sure the battery/card compartment cover is closed before using the camera.

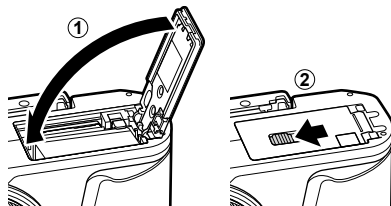

Removing the card

Press the inserted card lightly and it will be ejected. Pull out the card.

- Do not remove the card while the card write indicator is displayed (P. 24).

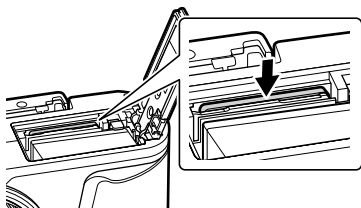

Attaching a lens to the camera

- 1 Remove the rear cap of the lens and the body cap of the camera.

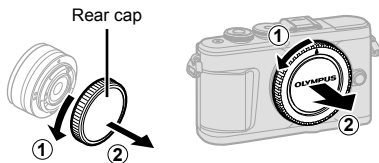

- 2 Align the lens attachment mark (red) on the camera with the alignment mark (red) on the lens, then insert the lens into the camera's body.

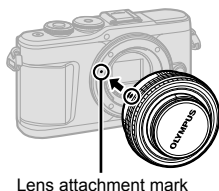

- 3 Rotate the lens clockwise until you hear it click (direction indicated by arrow 3).



- Make sure the camera is turned off when attaching or removing the lens.
- Do not press the lens release button.
- Do not touch internal portions of the camera.

■ Removing the lens cap

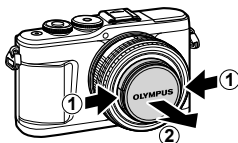
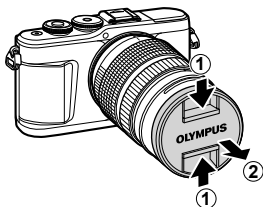

■ Removing the lens from the camera

Make sure the camera is turned off when removing the lens. While pressing the lens release button, rotate the lens in the direction of the arrow.

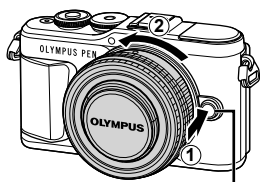

Lens release button

Interchangeable lenses

Read "Interchangeable lenses" (P. 148).

Turning the camera on

- 1 Press the **ON/OFF** button to turn on the camera.
 - When the camera is turned on, the monitor will turn on.

■ ON/OFF button

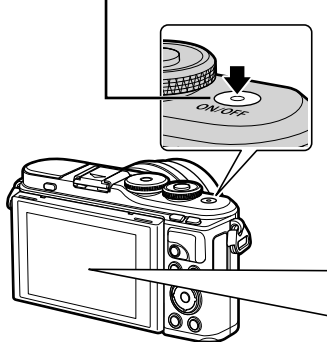

■ Monitor



Battery level

The battery level icon will be displayed.

- [Full battery icon] (green): The camera is ready to shoot.
- [Partial battery icon] (green): The battery is not full.
- [Low battery icon] (green): The battery is low.
- [Blinking battery icon] (blinks red): Charge the battery.



Camera sleep operation

If no operations are performed for a minute, the camera enters "sleep" (stand-by) mode to turn off the monitor and to cancel all actions. The camera activates again when you touch any button (the shutter button,  button, etc.). The camera will turn off automatically if left in sleep mode for 5 minutes. Turn the camera on again before use. You can choose how long the camera remains idle before entering sleep mode.  [Sleep] (P. 131)

Initial setup

After turning the camera on for the first time, perform the initial setup by choosing a language and setting the camera clock.

- Date and time information is recorded on the card together with the images.
- The file name is also included with the date and time information. Be sure to set the correct date and time before using the camera. Some functions cannot be used if the date and time have not been set.

- 1** Press the **OK** button when the initial setup dialog is displaying prompting you to choose a language.

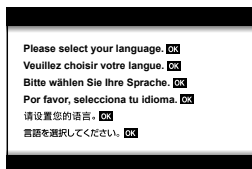

- 2** Highlight the desired language using the control dial or the **Δ ▽ ◀ ▶** buttons on the arrow pad.

- The language-selection dialog has two pages of options. Use the control dial or the **Δ ▽ ◀ ▶** buttons on the arrow pad to move the cursor between pages.

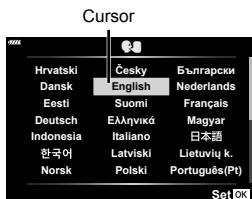

- 3** Press the **OK** button when the desired language is highlighted.

- If you press the shutter button before pressing the **OK** button, the camera will exit to shooting mode and no language will be selected. You can perform the initial setup by turning the camera off and then on again to display the initial setup dialog and repeating the process from Step 1.
- The language can be changed at any time from the **↓** setup menu. **↓** “Choosing a language ()” (P. 125)



- 4 Set the date, time, and date format.
- Use the ◀▶ buttons on the arrow pad to highlight items.
 - Use the ▲▼ buttons on the arrow pad to change the highlighted item.
 - The clock can be adjusted at any time from the ⌵ setup menu. ⌵ [O] (P. 124)

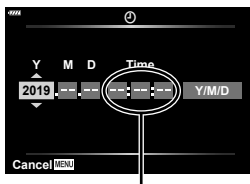

The time is displayed using a 24-hour clock.

- 5 Complete the initial setup.
- Press the [OK] button to set the clock.
 - If the battery is removed from the camera and the camera is left for a while, the date and time may be reset to the factory default setting.
 - You may also need to adjust the frame rate before shooting movies. ⌵ [Video Frame Rate] (P. 119)

Turning the camera off

Press the **ON/OFF** button to turn the camera off. See page 138 for information on how to proceed if the camera displays the dialog shown in the illustration.

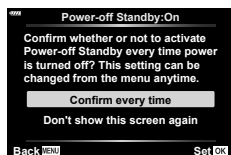
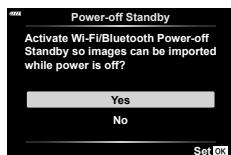

Camera displays unreadable/not in the selected language

If the camera displays are in an unfamiliar language or use characters you are unable to read, you may have accidentally selected the wrong language in the language-selection dialog. Follow the steps below to change languages.

- 1 Press the **MENU** button to display the menus.
- 2 Highlight the **Y** tab using Δ ∇ and press the **OK** button.

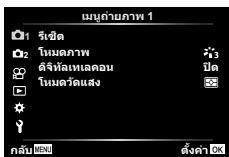

- 3 Highlight [**Y**] using Δ ∇ and press the **OK** button.
- 4 Highlight the desired language using Δ ∇ \leftarrow \rightarrow and press the **OK** button.



2 Shooting

Information displays while shooting

Monitor display during still photography

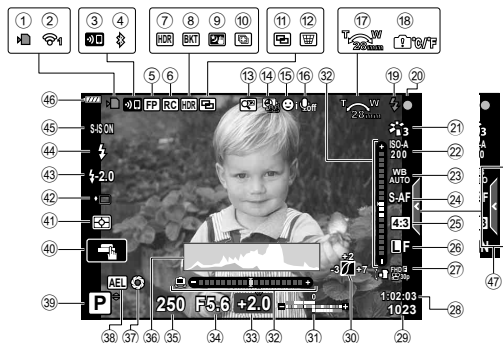

- | | | |
|---|---|--|
| ① Card write indicator.....P. 17 | ②③ Wireless LAN connection statusP. 136–143 | ②③ White balance.....P. 80 |
| ③ Wireless LAN connection starting upP. 136–143 | ④ Connected via BluetoothP. 136–143 | ②④ AF mode.....P. 81 |
| ④ Super FP flash.....P. 149 | ⑤ Super FP flash.....P. 149 | ②⑤ Aspect ratio.....P. 83 |
| ⑥ RC mode.....P. 149 | ⑦ HDR.....P. 41 | ②⑥ Image quality (still images).....P. 83 |
| ⑦ HDR.....P. 41 | ⑧ AE Bracketing.....P. 45 | ②⑦ Record mode (movies).....P. 84 |
| ⑧ AE Bracketing.....P. 45 | ⑨ Focus Bracketing.....P. 46 | ②⑧ Available recording time |
| ⑨ Focus Bracketing.....P. 46 | ⑩ Handheld Starlight.....P. 34 | ②⑨ Number of storable still pictures...P. 147 |
| ⑩ Handheld Starlight.....P. 34 | ⑪ Multi Focus Shot.....P. 36 | ③⑩ Highlight & shadow control.....P. 96 |
| ⑪ Multi Focus Shot.....P. 36 | ⑫ Multiple exposure.....P. 40 | ③① Top: Flash intensity control.....P. 88 Bottom: Exposure compensation...P. 69 |
| ⑫ Multiple exposure.....P. 40 | ⑬ Digital Tele-converter.....P. 115 | ③② Level gauge.....P. 26 |
| ⑬ Digital Tele-converter.....P. 115 | ⑭ Time lapse shooting.....P. 116 | ③③ Exposure compensation value.....P. 69 |
| ⑭ Time lapse shooting.....P. 116 | ⑮ Face priority/Eye priority.....P. 71 | ③④ Aperture value.....P. 51–54 |
| ⑮ Face priority/Eye priority.....P. 71 | ⑯ Movie sound.....P. 58, 108, 119, 121 | ③⑤ Shutter speed.....P. 51–54 |
| ⑯ Movie sound.....P. 58, 108, 119, 121 | ⑰ Zoom operation direction/Focal length | ③⑥ Histogram.....P. 26 |
| ⑰ Zoom operation direction/Focal length | ⑱ Internal temperature warning °C/°FP. 160 | ③⑦ Preview.....P. 98 |
| ⑱ Internal temperature warning °C/°FP. 160 | ⑲ Flash.....P. 72 (blinks: charging in progress, lights up: charging completed) | ③⑧ AE lock.....P. 98, 131 |
| ⑲ Flash.....P. 72 (blinks: charging in progress, lights up: charging completed) | ⑳ AF confirmation mark.....P. 28 | ③⑨ Shooting mode.....P. 27–62 |
| ⑳ AF confirmation mark.....P. 28 | ㉑ Picture mode.....P. 78, 115 | ④① Touch operation.....P. 57 |
| ㉑ Picture mode.....P. 78, 115 | ㉒ ISO sensitivity.....P. 79 | ④② Metering mode.....P. 91 |
| ㉒ ISO sensitivity.....P. 79 | | ④③ Sequential shooting/Self-timer.....P. 74 Silent shooting.....P. 42 |
| | | ④④ Flash intensity control.....P. 88 |
| | | ④⑤ Flash mode.....P. 72 |
| | | ④⑥ Image stabilizer.....P. 89 |
| | | ④⑦ Battery level.....P. 20 |
| | | ④⑧ Live guide recall.....P. 31 |

Monitor display during movie mode





- ④⑧ Recording level meter.....P. 119
- ④⑨ Silent shooting tabP. 66
- ⑤⑩ Movie (exposure) mode.....P. 87
- ⑤⑪ Movie effectP. 61

Switching the information display

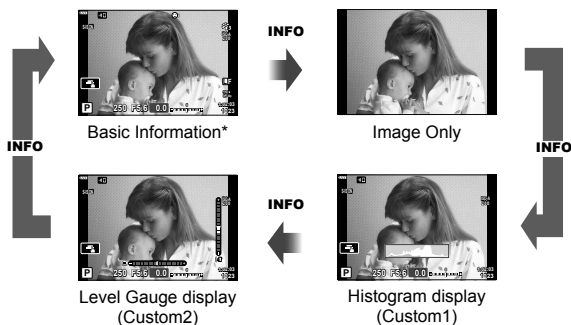
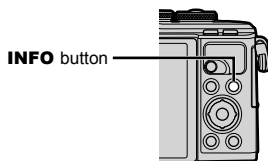
You can switch the information displayed in the monitor during shooting using the **INFO** button.



* Not displayed in  mode (movie mode) unless recording is in progress.

- You can change Custom1 and Custom2 settings.   [Info Settings] > [LV-Info] (P. 127)
- The information display screens can be switched in either direction by rotating the control dial while pressing the **INFO** button.

Histogram display

A histogram showing the distribution of brightness in the image is displayed. The horizontal axis gives the brightness, the vertical axis the number of pixels of each brightness in the image. During shooting, overexposure is indicated in red, underexposure in blue, and the range metered using spot metering in green.



Level gauge display

The orientation of the camera is indicated. The “tilt” direction is indicated on the vertical bar and the “horizon” direction on the horizontal bar. The camera is level and plumb when the bars turn green.

- Use the indicators on the level gauge as a guide.
- Error in the display can be corrected via calibration (P. 131).

Choosing a shooting mode and taking photos

Use the mode dial to select the shooting mode, and then shoot the image.

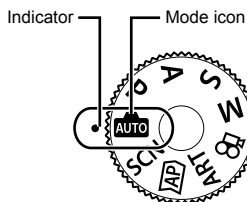

Types of shooting modes

For how to use the various shooting modes, see the following.

| Shooting mode | Description | |
|---------------|--|----|
| | The camera automatically selects the most appropriate shooting mode. | 31 |
| SCN | The camera automatically optimizes settings for the subject or scene. | 33 |
| | Use for quick access to advanced shooting settings. | 37 |
| ART | You can shoot with the effect of artistic expression added. | 47 |
| P | The camera meters subject brightness and automatically adjusts shutter speed and aperture for optimal results. | 51 |
| A | You choose the aperture and the camera automatically adjusts shutter speed for optimal results. | 52 |
| S | You choose the shutter speed and the camera automatically adjusts aperture for optimal results. | 53 |
| M | You choose both the aperture and shutter speed. | 54 |
| | Shoot movies of various types. | 59 |

Functions that cannot be selected from menus

Some items may not be selectable from the menus when using the arrow pad.

- Items that cannot be set with the current shooting mode.
- Items that cannot be set because of an item that has already been set:
Settings such as picture mode are unavailable when the mode dial is rotated to .

- 1 Rotate the mode dial to choose a mode.

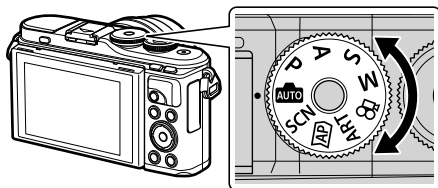

- 2 Frame the shot.

- Be careful that your fingers or the camera strap do not obstruct the lens or AF illuminator.

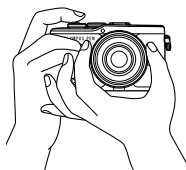

Landscape position

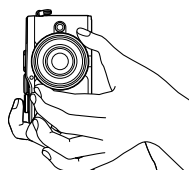

Portrait position

- 3 Adjust the focus.

- Display the subject in the center of the monitor, and lightly press the shutter button down to the first position (press the shutter button halfway).
The AF confirmation mark (●) will be displayed, and a green frame (AF target) will be displayed in the focus location.

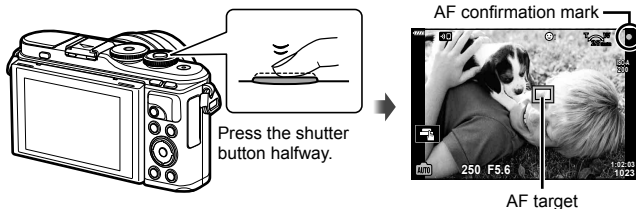

- If the AF confirmation mark blinks, the subject is not in focus. (P. 156)

- 4 Release the shutter.

- Press the shutter button all the way (fully).
- The camera will release the shutter and take a picture.
- The shot image will be displayed on the monitor.

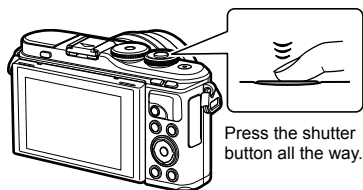

Notes

- You can focus and take pictures using touch controls.  "Shooting with touch screen operations" (P. 57)
- To exit to shooting mode from menus or playback, press the shutter button halfway.

Taking high angle and low angle shots

You can change the orientation and angle of the monitor.

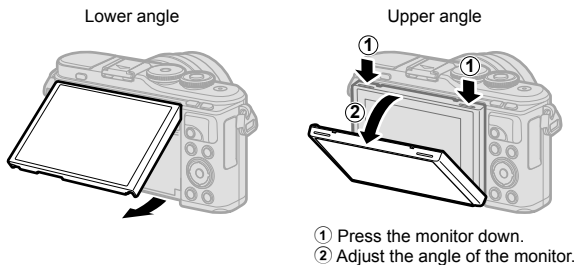

Rotating the Monitor: Cautions

- Rotate the monitor gently within the limits shown. Do not use force; failure to observe this precaution could damage the connectors.
- Do not touch the areas indicated in the illustration. Failure to observe this precaution could damage the product or cause it to malfunction.

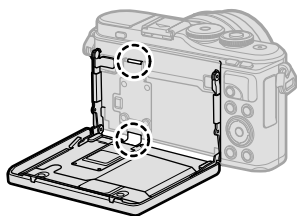

Notes

- Inverting the monitor allows you to take pictures of yourself while you preview the frame.
👉 “Taking Photos in Self-Portrait Mode” (P. 67)

Switching Displays with the (Shortcut) Button

Press the  button to switch to each screen of the selected shooting mode between shots.

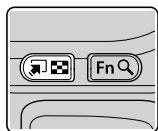

 (Shortcut) button

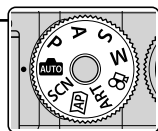
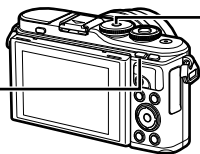

Mode dial



Live guide (P. 31)



SCN

Scene mode (P. 33)



Advanced photo mode (P. 37)



ART

Art filter mode (P. 47)



P/A/S/M

LV super control panel (P. 77)



Movie mode (P. 59)



Letting the camera choose the settings (AUTO mode)

The camera adjusts settings to suit the scene; all you have to do is press the shutter button. Set the mode dial to .

Using live guides

Use live guides to easily adjust such parameters as color, brightness, and background blurring.

1 Press the  button to display live guides.

- Use Δ ∇ to highlight an item in the live guide and press \odot to display a slider.



Guide item

2 Use Δ ∇ to position the slider and choose a level.

- Press the \odot button to save changes.
- To exit, press the **MENU** button.
- When [Shooting Tips] is selected, use Δ ∇ to highlight the item and press the \odot button to display the detail.
- The effect of the selected level is visible in the display.
If [Blur Background] or [Express Motions] is selected, the display will return to normal, but the selected effect will be visible in the final photograph.



Slider

3 To set multiple live guides, repeat Steps 1 and 2.

- A check is displayed on the guide item for live guides that are already set.
- [Blur Background] and [Express Motions] cannot be set at the same time.



4 Shoot.

- To clear the live guides from the display, press the **MENU** button.
- If [RAW] is currently selected for image quality, image quality will automatically be set to RAW+JPEG.
- Live guide settings are not applied to the RAW copy.
- Pictures may appear grainy at some live guide setting levels.



- Changes to live guide setting levels may not be visible in the monitor.
- Frame rates drop the closer the [Express Motions] slider is to [Blurred Motion].
- The flash cannot be used when a live guide is set.
- Choosing live guide settings that exceed the limits of the camera exposure meters may result in pictures that are overexposed or underexposed.

Notes

- Touch controls can also be used.

One-Touch e-Portrait

To enable one-touch e-Portrait so that the camera smooths the complexions of portrait subjects, tap the

 Off (one-touch e-Portrait) icon to turn it on ( On).

 "Shooting with touch screen operations" (P. 57)



One-touch e-Portrait icon

Shooting in scene mode (SCN mode)

The camera automatically optimizes settings for the subject or scene.

- 1 Rotate the mode dial to **SCN**.

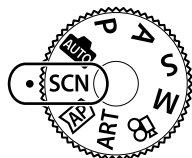

- 2 Use Δ ∇ \triangleleft \triangleright to highlight a scene and press the \odot button.



- 3 Use \triangleleft \triangleright to highlight a scene mode and press the \odot button.
 - Press the \blacktriangleright button to choose a different scene.















- 4 Shoot.











Notes





- Touch controls can also be used.



Types of scene modes

| Subject type | Scene mode | Description |
|--------------|---|--|
| People |  Portrait | Suitable for portrait shooting. Brings out skin texture. |
| |  e-Portrait | Smooths out skin tones and texture. This mode is suitable when viewing images on a high-definition TV. The camera records two pictures: one with the effect applied and one without. |
| |  Portrait + Landscape | Suitable for portraits featuring a landscape in the background. Blues, greens, and skin tones are captured beautifully. |
| |  Portrait + Nightscape | Suitable for portrait shooting against a background of night view. Raise the flash (P. 72). Use of a tripod and remote control via OI.Share is recommended (P. 137, 141). |
| |  Children | Suitable for photographs of children and other active subjects. |

| Subject type | Scene mode | Description |
|--------------|---|---|
| Nightscapes |  Nightscape | Suitable for tripod shooting of night scenes. Use of a tripod and remote control via OI.Share is recommended (P. 137, 141). |
| |  Portrait + Nightscape | Suitable for portrait shooting against a background of night view. Raise the flash (P. 72). Use of a tripod and remote control via OI.Share is recommended (P. 137, 141). |
| |  Handheld Starlight | Suitable for shooting night scenes without a tripod. Reduces blur when shooting low light/illuminated scenes. The camera makes eight exposures and combines them into a single photograph. |
| |  Fireworks | Suitable for shooting fireworks at night. Use of a tripod and remote control via OI.Share is recommended (P. 137, 141). |
| |  Light Trails | The camera automatically shoots multiple images, takes newly bright areas only, and composites them into a single image. With normal long exposure, an image of light trace such as star trails with bright buildings tends to get too bright. You can capture them without over exposure while checking the progress. Press the shutter button to start shooting, then view the changing result in the monitor and press the shutter button again to end shooting once the desired result is achieved (maximum 3 hours). Use of a tripod and remote control via OI.Share is recommended (P. 137, 141). • Advanced settings can be accessed via live composite photography (dark and light field composite) in M mode (P. 56). |
| Motion |  Sport | Suitable for fast action shooting. The camera will take photos while the shutter button is pressed. |
| |  Children | Suitable for photographs of children and other active subjects. |
| |  Panning | Choose to blur the background behind moving objects. The camera chooses the optimal shutter speed for panning shots based on camera motion. |

| Subject type | Scene mode | Description |
|--------------|---|---|
| Scenery |  Landscape | Suitable for landscape shooting. |
| |  Sunset | Suitable for shooting the sunset. |
| |  Beach & Snow | Suitable for shooting at snow-capped mountains, seascapes in the sun, and other whitish scenes. |
| |  Panorama | Take panoramic photos with a wider angle of view than other shots. • For information on taking photos using this feature, see “Shooting a Panorama” (P. 43), starting from Step 3. |
| |  Backlight HDR | Suitable for high-contrast scenes. Each time the shutter button is pressed, the camera takes four shots and subsequently merges them into one, correctly exposed image. |
| Indoors |  Candlelight | Suitable for shots of candlelit scenes. Warm colors are preserved. |
| |  Silent [♥] | Disable camera sounds and lights in situations in which they may be unwelcome. • For information on taking photos using this feature, see “[Silent [♥]] Mode” (P. 42), starting from Step 2. |
| |  Portrait | Suitable for portrait shooting. Brings out skin texture. |
| |  e-Portrait | Smooths out skin tones and texture. This mode is suitable when viewing images on a high-definition TV. The camera records two pictures: one with the effect applied and one without. |
| |  Children | Suitable for photographs of children and other active subjects. |
| |  Backlight HDR | Suitable for high-contrast scenes. Each time the shutter button is pressed, the camera takes four shots and subsequently merges them into one, correctly exposed image. |

| Subject type | Scene mode | Description |
|--------------|--|--|
| Close-ups |  Macro | Suitable for close-ups. |
| |  Nature Macro | Suitable for vivid close-ups of flowers or insects. |
| |  Documents | Suitable for photos of timetables or other documents. The camera heightens the contrast between the text and background. |
| |  Multi Focus Shot | The camera takes eight photos, varying the focus distance with each shot. <ul style="list-style-type: none"> For information on taking photos using this feature, see “[Focus Bracketing]: Varying Focus Distance over a Series of Shots” (P. 46), starting from Step 2. |

- To maximize the benefits of the scene modes, some of the shooting function settings are disabled.
- Some time may be needed to record pictures taken using [e-Portrait]. In addition, when the image quality mode is [RAW], the image is recorded in RAW+JPEG.
- Movies cannot be recorded using [e-Portrait], [Handheld Starlight], [Panorama], or [Backlight HDR].
- [Handheld Starlight] pictures taken with [RAW] selected for image quality will be recorded in RAW+JPEG format, with the first frame recorded as a RAW image and the final composite as a JPEG image.
- [Backlight HDR] records HDR-processed images in JPEG format. When the image quality mode is set to [RAW], the image is recorded in RAW+JPEG.
- In [Panning],  is displayed during panning detection, and  is displayed when nothing is detected.
- When using a lens with an image stabilizer switch in [Panning], turn the image stabilizer switch off.
Sufficient panning effects may not be obtained in bright conditions. Use a commercially available ND filter to obtain effects more easily.

Shooting in advanced photo mode (AP mode)

Use for quick access to advanced shooting settings.

- 1 Rotate the mode dial to **AP**.

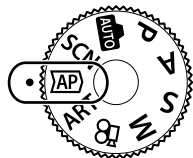

- 2 Use **<D>** to highlight an AP mode.
 - Some modes offer additional options that can be accessed using **∇**.



- 3 Press the **OK** button to select the highlighted mode.
 - Press the **↔** button to choose a different mode. If additional options are displayed, press **Δ**.



Notes

- Exposure compensation (P. 69) and program shift (P. 51) are available in some AP modes.
- Touch controls can also be used.

AP Mode Options

| AP mode | Description | |
|------------------------------|---|----|
| Live Composite | Record light trails from stars and other objects while keeping exposure constant overall. | 38 |
| Live Time | Choose for photos of fireworks and night scenery. Make long time exposures at selected shutter speeds. | 39 |
| Multiple Exposure | Combine two different images on top of one another. | 40 |
| HDR | Capture details in both highlights and shadows. | 41 |
| Silent [♥] | Disable camera sounds and lights in situations in which they may be unwelcome. | 42 |
| Panorama | Take a series of shots that are joined together to create a wide-angle photo. Choose from two angles of view: a wider angle than normal shots (STD), or an even wider angle (FULL). | 43 |
| Keystone Compensation | Correct the effects of perspective in photos of buildings or landscapes. | 44 |
| AE Bracketing | Each time the shutter button is pressed, the camera takes a series of photos, varying exposure with each shot. | 45 |
| Focus Bracketing | Each time the shutter button is pressed, the camera takes a series of eight photos, varying the focus distance with each shot. | 46 |

[Live Composite]: Live Composite Photography

Create photos that record light trails from stars and other objects without changing the brightness of the background; during shooting, the changing results can be viewed in the monitor. You can adjust white balance or picture mode and other settings not available with the **SCN** mode “Light Trails” option.

- 1 Highlight [Live Composite] in the AP mode menu (P. 37) and press the  button.
- 2 Press the shutter button halfway down to focus.
 - To reduce blur caused by camera shake, fix the camera securely to a tripod and use a remote shutter release controlled via OI.Share (P. 141) in wireless remote mode.
 - If the focus indicator blinks, the camera is not in focus.
- 3 Press the shutter button all the way down to shoot.
 - The camera configures the proper settings automatically and starts shooting.
 - After pressing the shutter button, there is a time lag until shooting starts.
 - The composite image will be displayed at regular intervals.
- 4 Press the shutter button again to stop shooting.
 - View the changing result in the monitor and press the shutter button to end shooting once the desired result is achieved.
 - The recording length in one shooting is up to 3 hours.



Notes

- Advanced settings can be accessed via live composite photography (dark and light field composite) in **M** mode (P. 56).

[Live Time]: Live Time Photography

You can make long exposures without having to keep the shutter button pressed. The changing result can be viewed in the monitor during shooting.

1 Highlight [Live Time] in the AP mode menu (P. 37).

2 Press ∇ , use \triangleleft \triangleright to choose the maximum exposure time, and press the \odot button.

- The display refresh rate may change automatically depending on the maximum exposure time selected.
- The shorter the maximum exposure time, the faster the display refresh rate.



3 Press the shutter button halfway down to focus.

- To reduce blur caused by camera shake, fix the camera securely to a tripod and use a remote shutter release controlled via OI.Share (P. 141) in wireless remote mode.
- If the focus indicator blinks, the camera is not in focus.

4 Press the shutter button all the way down to start live time photography.

- The camera adjusts settings automatically and begins shooting.
- The changing result can be viewed in the monitor.

5 Press the shutter button again to stop shooting.





- View the changing result in the monitor and press the shutter button to end shooting once the desired result is achieved.
- Shooting ends automatically when the selected exposure time is reached.

Notes

- The long exposure (bulb/time) options in **M** mode offer more advanced settings (P. 55).

[Multiple Exposure]: Shooting Multiple Exposures

Combine two different images on top of one another.

- 1 Highlight [Multiple Exposure] in the AP mode menu (P. 37) and press the  button.
- 2 Press the shutter button halfway down to focus.
 - If the focus indicator blinks, the camera is not in focus.
- 3 Press the shutter button all the way down for the first shot.
 -  is displayed in green if shooting starts.
 - The image is shown superimposed on the monitor.
 - Press  to delete the last shot.
- 4 Take the second shot.
 - Use the first image as a guide to compose the second shot.
 - The camera will not go to sleep while multiple exposure is in effect.
 - Performing any of the following actions automatically deletes the second shot:
The camera is turned off, the  button is pressed, the **MENU** button is pressed, pressing the  button, rotating the mode dial, the battery power runs out, or any cable is connected to the camera.



Tips

- For more information on creating image overlays:  "Image overlay" (P. 122)

[HDR]: Taking Composite Photos with HDR

Capture details in both highlights and shadows. The camera varies exposure over a series of four shots and combines them into a single image.

- 1 Highlight [HDR] in the AP mode menu (P. 37).
- 2 Press ∇ , use $\triangleleft \triangleright$ to choose [HDR1] or [HDR2], and press the OK button.



| | |
|-------------|--|
| HDR1 | Four shots are taken, each with a different exposure, and the shots are combined into one HDR image inside the camera. HDR2 provides a more impressive image than HDR1. ISO sensitivity is fixed to 200. |
| HDR2 | |







- 3 Press the shutter button halfway down to focus.
 - If the focus indicator blinks, the camera is not in focus.
- 4 Press the shutter button all the way down to start HDR photography.
 - The camera automatically takes four shots when the shutter button is pressed.
 - Noise may be more noticeable in photos taken in conditions associated with slow shutter speeds.
 - For best results, secure the camera by, for example, mounting it on a tripod.
 - The image displayed on the monitor while shooting will differ from the HDR-processed image.
 - The HDR-processed image will be saved as a JPEG file. When the image quality mode is set to [RAW], the image is recorded in RAW+JPEG.
 - The picture mode is fixed to [Natural] and the color space is fixed to [sRGB].

[Silent [♥]] Mode

Disable camera sounds and lights in situations in which they may be unwelcome.

- 1 Highlight [Silent [♥]] in the AP mode menu (P. 37) and press the  button.
 - 2 Press the shutter button halfway down to focus.
 - If the focus indicator blinks, the camera is not in focus.
 - 3 Press the shutter button all the way down to shoot.
 - When the shutter is released, the monitor screen will go dark for a moment. No shutter sound will be emitted.
- The desired results may not be achieved under flickering light sources such as fluorescent or LED lamps or if the subject moves abruptly during shooting.
 - When [Silent [♥]] is selected in the **SCN** or **AP** mode, the following measures are undertaken to reduce the sound and light produced by the camera.
 - Electronic shutter: Enabled
 - ): Off
 - AF Illuminator: Off
 - Flash mode: Off
 - Noise reduction is not available when [Silent [♥]] is selected in the **SCN** or **AP** mode.
 - Note that due to the electronic shutter, the subject may appear to be distorted in photographs if camera moves quickly during shooting or when shooting fast-moving subjects.

Notes



- Press  for sequential/self-timer photography (P. 74).
- Advanced settings (P. 117) can be used when you select Silent [♥] photography using the   () button (P. 75) in the **P/A/S/M/ART** mode .

Shooting a Panorama

Pan the camera following an on-screen guide to create a single wide-angle (panorama) photo.

1 Highlight [Panorama] in the AP mode menu (P. 37).

2 Press ∇ , then use $\triangleleft \triangleright$ to highlight the desired panorama type and press the \odot button.

| | |
|---|--|
|  | Take panorama photos with a wider angle of view than other shots. |
|  | Take panorama photos with a wider angle of view than  . |



3 Highlight a pan direction using $\triangle \nabla \triangleleft \triangleright$ and press the \odot button.

4 Press the shutter button halfway to focus.



5 Press the shutter button the rest of the way down to start shooting, and then pan the camera slowly in the direction indicated by the arrow in the display.

- The arrow in the display moves as the camera is panned.
- To cancel shooting and return to Step 3, press the **MENU** button.



6 When the arrow in the display reaches the end of the progress bar, shooting will end and the camera will create a panorama.

Notes

- Focus, exposure, and the like are fixed at the values in effect at the start of shooting.
- Before the arrow reaches the end of the progress bar, you can press the \odot button or press the shutter button again to end shooting and record a panorama from the data recorded to the current point.
- Shooting may be cancelled and an error displayed if:
 - the camera is panned too slowly or too quickly/the camera is panned diagonally/
 - the camera is panned in the opposite direction to the arrow in the display/the lens is zoomed in or out/panning does not start within a set period
- Panorama photography may be unavailable with some lenses.

[Keystone Compensation]

Correct the effects of perspective in photos of buildings or landscapes.

- 1 Highlight [Keystone Compensation] in the AP mode menu (P. 37) and press the **OK** button.
- 2 Make the vertical adjustment while viewing the effect in the display and frame the shot.
 - Use the control dial to choose the compensation amount.
 - Use $\Delta \nabla$ to choose the area to be recorded. Depending on the compensation amount, you may be unable to choose the area recorded.
 - Press and hold the **OK** button to cancel any changes.
- 3 Press the **INFO** button and then make the horizontal adjustment and frame the shot.
 - Use the control dial to choose the compensation amount.
 - Use $\triangleleft \triangleright$ to choose the area to be recorded. Depending on the compensation amount, you may be unable to choose the area recorded.
 - Press and hold the **OK** button to cancel any changes.
 - Press the **INFO** button to toggle between the vertical (Step 2) and horizontal (Step 3) adjustment displays as desired.
- 4 Press the shutter button halfway down to focus.
 - If the focus indicator blinks, the camera is not in focus.
- 5 Press the shutter button all the way down to shoot.
 - As the compensation amount increases:
 - The image will become coarser
 - The zoom ratio of the crop will increase
 - It will no longer be possible to reposition the crop in both the vertical and horizontal displays
 - Photos are recorded in RAW+JPEG format when [RAW] is selected for image quality.
 - The desired results may not be obtained with converter lenses.
 - Depending on the amount of correction, some AF targets may be outside the display area. An icon (\updownarrow , \leftarrow or \rightarrow) is displayed when the camera focuses on an AF target outside the display area.
 - If a focus distance is selected for [Image Stabilizer], the correction will be adjusted for the selected focus distance. Except when using a Micro Four Thirds or Four Thirds lens, choose a focal length using the [Image Stabilizer] option (P. 89).
 - You can not use the $\text{⚡} (\triangleright)$ button and $\text{📷} (\nabla)$ button for flash mode or continuous/self-timer mode selection while making keystone compensation adjustments. Use the LV super control panel (P. 77) instead.



[AE Bracketing]: Varying Exposure over a Series of Shots

Take a series of photos, varying exposure with each shot.

- 1 Highlight [AE Bracketing] in the AP mode menu (P. 37).
- 2 Press ∇ , use $\triangleleft \triangleright$ to choose the number of shots, and press the OK button.

| | |
|----|--|
| 3f | Take 3 shots, the first at optimal exposure (± 0.0 EV), the second at -1.0 EV, and the third at $+1.0$ EV. |
| 5f | Take 5 shots, the first at optimal exposure (± 0.0 EV), the second at -1.3 EV, the third at -0.7 EV, the fourth at $+0.7$ EV, and the fifth at $+1.3$ EV. |

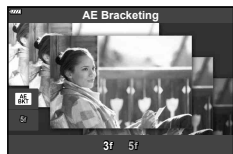



- 3 Press the shutter button halfway down to focus.
 - If the focus indicator blinks, the camera is not in focus.
- 4 Press the shutter button all the way down to shoot.
 - Take the set number of shots.
 - The BKT indicator turns green during bracketing.
 - The camera brackets the value currently selected for exposure compensation.

[Focus Bracketing]: Varying Focus Distance over a Series of Shots

Each time the shutter button is pressed, the camera takes a series of eight photos, varying the focus distance with each shot.

- 1 Highlight [Focus Bracketing] in the AP mode menu (P. 37).
- 2 Press ∇ , use $\triangleleft \triangleright$ to choose the amount focus distance changes with each shot, and press the OK button.

| | |
|---|--|
|  | The focus distance changes by a small amount with each shot. |
|  | The focus distance changes by a large amount with each shot. |



- 3 Press the shutter button halfway down to focus.
 - If the focus indicator blinks, the camera is not in focus.
- 4 Press the shutter button all the way down to shoot.
 - The camera takes eight photos, varying the focus distance with each shot. The camera will take pictures at, and at distances in front of and behind, the focus distance chosen when the shutter button is pressed halfway.
 - The **[BKT]** indicator turns green during bracketing.
 - Focus bracketing ends if zoom is adjusted during shooting.
 - Shooting ends when focus reaches ∞ (infinity).
 - Focus bracketing uses the electronic shutter.
 - Focus bracketing is not available with lenses that have mounts conforming to the Four Thirds or some Micro Four Thirds standards.

Using art filters (ART mode)

Using art filters, you can easily have fun with artistic effects.

- 1 Rotate the mode dial to **ART**.

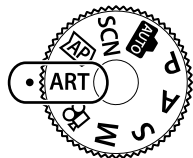

2

Shooting

- 2 Use $\triangleleft \triangleright$ to highlight a filter.

- The slider appears on the display when [Pop Art I] or [Soft Focus] is highlighted. Use the slider to adjust the degree of the art filter effect (P. 50).



Slider

- 3 Press ∇ , and highlight an effect using $\triangleleft \triangleright$.

- The effects available vary with the selected filter (Soft Focus Effect, Pin Hole Effect, Frame Effect, White Edge Effect, Star Light Effect, Color Filter, Monochrome Color, Blur Effect, or Shade Effect).



Slider

- 4 Press ∇ to adjust exposure compensation.

- The slider will appear on the display.
- Rotate the control dial to adjust exposure compensation.
- Choose positive (“+”) values to make pictures brighter, negative (“-”) values to make pictures darker. Exposure can be adjusted by ± 5.0 EV. During live view, the brightness of the monitor will be adjusted to a maximum of only ± 3.0 EV. If the exposure exceeds ± 3.0 EV, the exposure bar will begin flashing.
- To reset exposure compensation, press and hold the \odot button.





Exposure bar

- 5 Press the \odot button.

- 6 Shoot.

- Press the \blacktriangleright button to choose a different art filter. If effects are displayed, press \triangleleft . If [Exposure/Brightness] is displayed, press ∇ .

 **Notes**

- [Color Filter] (P. 93) and [Monochrome Color] (P. 94) options are available with some art filters.
- Exposure compensation (P. 69) can also be adjusted between shots by rotating the control dial or by pressing the  (Δ) button and then using <D>.
- Program shift (P. 51) can be adjusted by pressing the  (Δ) button and then using Δ ▽.
- Touch controls can also be used.

Types of art filters

| | |
|----------------------------------|---|
| Pop Art I/II | Creates an image that emphasizes the beauty of color. |
| Soft Focus | Creates an image that expresses a soft tone atmosphere. |
| Pale&Light Color I/II | Creates an image that expresses warm light by scattering overall light and slightly overexposing the image. |
| Light Tone | Creates a high-quality image by softening both shadows and highlights. |
| Grainy Film I/II | Creates an image that expresses the roughness of black and white images. |
| Pin Hole I/II/III | Creates an image that looks as if it was taken using an old or toy camera by dimming the image perimeter. |
| Diorama I/II | Creates a miniature-like image by emphasizing saturation and contrast, and blurring unfocused areas. |
| Cross Process I/II | Creates an image that expresses a surreal atmosphere. Cross Process II creates an image that emphasizes magenta. |
| Gentle Sepia | Creates a high-quality image by drawing out shadows and softening the overall image. |
| Dramatic Tone I/II | Creates an image that emphasizes the difference between brightness and darkness by partially increasing contrast. |
| Key Line I/II | Creates an image that emphasizes edges and adds an illustrative style. |
| Watercolor I/II | Creates a soft, bright image by removing dark areas, blending pale colors on a white canvas, and further softening contours. |
| Vintage I/II/III | Expresses an everyday shot in a nostalgic, vintage tone using printed film discoloration and fading. |
| Partial Color I/II/III | Impressively expresses a subject by extracting colors you want to emphasize and keeping everything else monotone. |
| Bleach Bypass I/II | The "bleach bypass" effect, which you may recognize from motion pictures and the like, can be used to great effect in shots of streetscapes or metal objects. |
| Instant Film | A contemporary take on the skin tones and shadow gradations typical of film. |

II and III are altered versions of the original (I).

- To maximize the benefits of the art filters, some of the shooting function settings are disabled.
- If [RAW] is currently selected for image quality (P. 83), image quality will automatically be set to RAW+JPEG. The art filter will be applied to the JPEG copy only.
- Depending on the subject, tone transitions may be ragged, the effect may be less noticeable, or the image may become more "grainy."
- Some effects may not be visible during movie recording.
- Your choice of filters, effects, and movie quality when recording movies may affect playback speed and smoothness.

Adjusting the degree of the art filter effect (Fine-Tuning)

You can adjust the degree of the filter effect for Pop Art I and Soft Focus before taking pictures.

- 1 Select [Pop Art I] or [Soft Focus] in the art filter menu (P. 49).
 - The slider will appear on the display.
 - Rotate the control dial to fine-tune the art filter.
 - Touch controls can also be used.
 - The effect is visible in the display.
 - To reset the filter effect, press and hold the **OK** button.

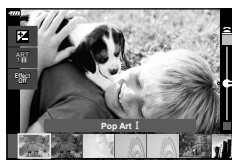

Slider

- 2 Press the **OK** button.
- 3 Shoot.
 - Press the **Reset** button if you want to fine-tune the art filter again.

Using [Partial Color]

Record only selected hues in color.

- 1 Select [Partial Color I/II/III] in the art filter menu (P. 49).
 - A color ring appears in the display.



- 2 Rotate the control dial to select a color.
 - The effect is visible in the display.
 - Touch controls can also be used.
- 3 Press the **OK** button.
- 4 Shoot.
 - To choose a different color after shooting, press the **Reset** button.

Letting the camera choose aperture and shutter speed (Program mode)

P mode is a shooting mode where the camera automatically sets the optimal aperture and shutter speed according to subject brightness. Set the mode dial to **P**.

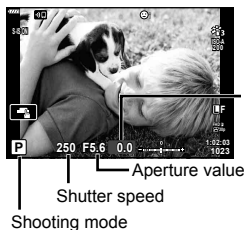
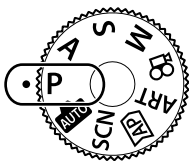

- The shutter speed and aperture selected by the camera are displayed.
- Exposure compensation (P. 69) can be adjusted by rotating the control dial or by pressing the \square (Δ) button and then using $\leftarrow \triangleright$.
- The shutter speed and aperture value displays will blink if the camera is unable to achieve correct exposure.
The aperture value at the moment when its indication blinks varies with the lens type and focal length of the lens.
When using a fixed [ISO] setting, change the setting. \mathcal{I} “Changing ISO sensitivity (ISO)” (P. 79)

| Warning display example (blinking) | Status | Action |
|------------------------------------|----------------------------|--|
| | The subject is too dark. | Use the flash. |
| | The subject is too bright. | <ul style="list-style-type: none"> • The metered range of the camera is exceeded. A commercially available ND filter (for adjusting the amount of light) is required. • Shutter speeds as fast as 1/16000 s are available in \heartsuit (silent) mode. \mathcal{I} “The Electronic Shutter (Silent \heartsuit)” (P. 75) |

Program shift (Ps)

In **P** mode, **ART** mode, and some **AP** modes, you can choose other combinations of aperture and shutter speed that will produce the same exposure. Press \square (Δ) button, then press $\Delta \nabla$ to set program shift so that “s” appears next to the shooting mode. To cancel program shift, press $\Delta \nabla$ until “s” is no longer displayed.

- Program shift is not available in other modes or when the flash is used.



Program shift

Choosing aperture (Aperture Priority mode)

A mode is a shooting mode where you choose the aperture and let the camera automatically adjust to the appropriate shutter speed. Rotate the mode dial to **A** and then use the control dial to select an aperture value.

Larger apertures (lower F-numbers) decrease depth of field (the area in front of or behind the focus point that appears to be in focus), softening background details.

Smaller apertures (higher F-numbers) increase depth of field.

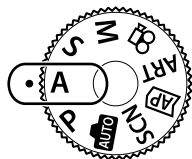

Aperture value

- After pressing the \square (Δ) button, you can also use Δ ∇ to choose the aperture.
- Exposure compensation (P. 69) can be adjusted by rotating the control dial or by pressing the \square (Δ) button and then using \triangleleft \triangleright .

Setting the aperture value

Decreasing aperture value \leftarrow

\rightarrow Increasing aperture value

F2.8 \leftarrow F4.0 \leftarrow **F5.6** \rightarrow F8.0 \rightarrow F11

(Decreasing depth of field) \leftarrow

\rightarrow (Increasing depth of field)

- The shutter speed display will blink if the camera is unable to achieve correct exposure. When using a fixed [ISO] setting, change the setting. \mathbb{I} \mathbb{S} "Changing ISO sensitivity (ISO)" (P. 79)

| Warning display example (blinking) | Status | Action |
|------------------------------------|------------------------------|--|
| | The subject is underexposed. | Decrease the aperture value. |
| | The subject is overexposed. | <ul style="list-style-type: none"> • Increase the aperture value. • If the warning display does not disappear, the metered range of the camera is exceeded. A commercially available ND filter (for adjusting the amount of light) is required. • Shutter speeds as fast as 1/16000 s are available in \heartsuit (silent) mode. \mathbb{I} \mathbb{S} "The Electronic Shutter (Silent \heartsuit)" (P. 75) |

Choosing shutter speed (Shutter Priority mode)

S mode is a shooting mode where you choose the shutter speed and let the camera automatically adjust to the appropriate aperture value. Rotate the mode dial to **S** and then use the control dial to select shutter speed.

Fast shutter speeds freeze motion of fast-moving subjects. Slow shutter speeds add motion by blurring moving subjects.

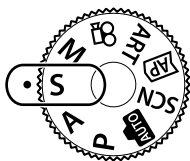

Exposure compensation amount

Shutter speed

- After pressing the \square (Δ) button, you can also use Δ / ∇ to choose the shutter speed.
- Exposure compensation (P. 69) can be adjusted by rotating the control dial or by pressing the \square (Δ) button and then using \leftarrow / \rightarrow .

Setting the shutter speed

Slower shutter speed \leftarrow \rightarrow Faster shutter speed

60" \leftarrow 15 \leftarrow 30 \leftarrow **60** \rightarrow 125 \rightarrow 250 \rightarrow 4000

(Add motion) \leftarrow \rightarrow (Freeze motion)

- The aperture value display will blink if the camera is unable to achieve correct exposure. The aperture value at the moment when its indication blinks varies with the lens type and focal length of the lens.

When using a fixed [ISO] setting, change the setting. \mathbb{I} / \mathbb{S} "Changing ISO sensitivity (ISO)" (P. 79)

| Warning display example (blinking) | Status | Action |
|------------------------------------|------------------------------|---|
| | The subject is underexposed. | Set the shutter speed slower. |
| | The subject is overexposed. | <ul style="list-style-type: none"> • Set the shutter speed faster. • If the warning display does not disappear, the metered range of the camera is exceeded. A commercially available ND filter (for adjusting the amount of light) is required. • Shutter speeds as fast as 1/16000 s are available in \heartsuit (silent) mode. \mathbb{I}/\mathbb{S} "The Electronic Shutter (Silent \heartsuit)" (P. 75) |

Choosing aperture and shutter speed (Manual mode)

M mode is a shooting mode where you choose both the aperture value and shutter speed. Bulb, time, and live composite photography are also available. Rotate the mode dial to **M**, rotate the control dial to adjust the shutter speed, and after pressing the \square (Δ) button, rotate the control dial to adjust the aperture.

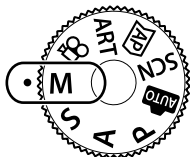

Difference from correct exposure

- After pressing the \square (Δ) button, you can also use Δ ∇ to choose the shutter speed.
- After pressing the \square (Δ) button, you can also use \triangleleft \triangleright to choose the aperture.
- The exposure determined by the aperture value and shutter speed you have set and the difference from the suitable exposure measured by the camera are displayed on the monitor.
- Shutter speed can be set to values between 1/4000 and 60 seconds or to [BULB], [LIVE TIME], or [LIVECOMP].
- Shutter speeds as fast as 1/16000 s are available in [\heartsuit] (silent) mode. \mathbb{I} \mathbb{S} "The Electronic Shutter (Silent [\heartsuit])" (P. 75)
- The brightness of the image displayed in the monitor will change with changes in aperture and shutter speed. You can fix the brightness of the display so that you can keep the subject in view while shooting. \mathbb{I} \mathbb{S} [Live View Boost] (P. 127)
- Even when you have set [Noise Reduct.], noise and/or light spots may still be noticeable in the image displayed on the monitor and shot images under certain environmental conditions (temperature etc.) and camera settings.

Noise in images

While shooting at slow shutter speeds, noise may appear on screen. These phenomena occur when the temperature rises in the image pickup device or image pickup device internal drive circuit, causing current to be generated in those sections of the image pickup device that are not normally exposed to light. This can also occur when shooting with a high ISO setting in a high-temperature environment. To reduce this noise, the camera activates the noise reduction function. \mathbb{I} \mathbb{S} [Noise Reduct.] (P. 128)

Shooting with long exposure time (BULB/LIVE TIME)

Use for photos such as fireworks or night scenery. In **M** mode, rotate the control dial in the direction shown until [BULB] or [LIVE TIME] is displayed in the monitor.

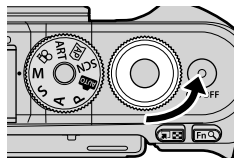

2

Shooting

Bulb photography (BULB):

The shutter remains open while the shutter button is pressed. The exposure ends when the shutter button is released. The view through the lens is not displayed while exposure is in progress.

Time photography (LIVE TIME):

The exposure begins when the shutter button is pressed all the way down. To end the exposure, press the shutter button all the way down again. The view through the lens is displayed while exposure is in progress.

- Press the **MENU** button to choose the display interval for [Live Bulb] or [Live Time] photography. Select [Off] to disable the display while exposure is in progress.
- To refresh the display while exposure is in progress, tap the monitor or press the shutter button halfway ([LIVE TIME] only).
- [BULB] and [LIVE TIME] are not available at some ISO sensitivity settings.
- To reduce blur caused by camera shake, fix the camera securely to a tripod and use a remote shutter release controlled via OI.Share (P. 141).
- During shooting, there are limits on the settings for the following functions.
Sequential shooting, self-timer shooting, time lapse shooting, image stabilizer, etc.

Live composite photography (dark and light field composite)

Combine several exposures to create a photo that records light trails from stars or fireworks and other objects without changing the brightness of the background.

1 In **M** mode, set the shutter speed to [LIVECOMP].

- In **M** mode, rotate the control dial in the direction shown until [LIVECOMP] is displayed in the monitor.

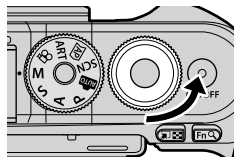

2 Press the **MENU** button to display [Composite Settings] and press $\Delta \nabla$ to choose the exposure time for the individual exposures.

3 Press the shutter button to ready the camera.

- The camera will shoot a frame as a reference for noise reduction.
- The camera is ready when [Ready for composite shooting] is displayed in the monitor.

4 Press the shutter button halfway down to focus.

- If the focus indicator blinks, the camera is not in focus.

5 Press the shutter button all the way down to start live composite photography.

- The combined image will be displayed in the monitor with each exposure.



6 Press the shutter button again to stop shooting.

- View the changing result in the monitor and press the shutter button to end shooting once the desired result is achieved.
 - The maximum length of composite shooting is 3 hours. However, the available shooting time will vary depending on shooting conditions, and charging state of the camera.
- There are limits on the available ISO sensitivity settings.
 - To reduce blur caused by camera shake, fix the camera securely to a tripod and use a remote shutter release controlled via OI.Share (P. 141).
 - During shooting, there are limits on the settings for the following functions.
 - Sequential shooting, self-timer shooting, time lapse shooting, image stabilizer, etc.

Shooting with touch screen operations

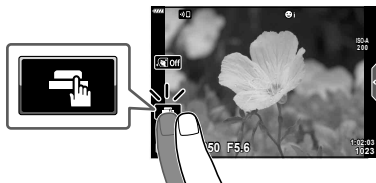
Tap  to cycle through touch screen settings.



| | |
|---|--|
|  | Tap a subject to focus and automatically release the shutter. This feature is not available in movie mode and during bulb, time, or composite photography. |
|  | Touch screen operations are disabled. |
|  | Tap to display an AF target and focus on the subject in the selected area. Photographs can be taken by pressing the shutter button. |

■ Previewing the subject ()

1 Tap the subject in the display.

- An AF target will be displayed.
- Use the slider to choose the size of the frame.
- Tap  to turn off the display of the AF target.



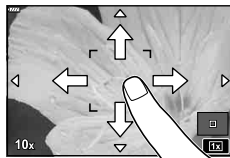

2 Tap to zoom in at the frame position.

- Use your finger to scroll the display when the picture is zoomed in.
- Tap  to cancel the zoom display.
- You cannot resize or zoom in on the target in movie mode.



- The situations in which touch screen operations are not available include the following.
One-touch WB, while buttons or dials are in use, etc.
- Do not touch the display with your fingernails or other sharp objects.
- Gloves or monitor covers may interfere with touch screen operation.
- You can disable the touch screen operation.  [Touchscreen Settings] (P. 131)

Recording movies in photo shooting modes

The  button can be used for movie recording even when the mode dial is not in the  position.

- Be sure that [ REC] is assigned to the  button (P. 97).

1 Press the button to begin recording.

- Movie you are recording will be displayed on the monitor.
- You can change the focus location by tapping the screen while recording.

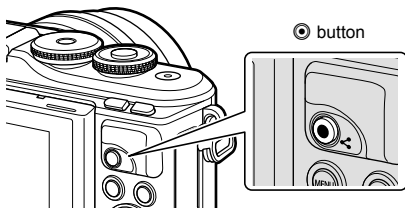

2 Press the button again to end recording.

- The sound of touch operations and button operations may be recorded.
- CMOS image sensors of the type used in the camera generate a so-called "rolling shutter" effect that can cause distortion in pictures of moving objects. This distortion is a physical phenomenon that occurs in pictures of fast-moving subjects or if the camera is moved during shooting. It is particularly noticeable in pictures taken at long focal lengths.
- If the size of the movie file being recorded exceeds 4 GB, the file will be split automatically. (Depending on shooting conditions, movies under 4 GB in size may be split into multiple files.)
- If the camera is used for extended periods, the temperature of the image pickup device will rise and noise and colored fog may appear in images. Turn off the camera for a short time. Noise and colored fog may also appear in images recorded at high ISO sensitivity settings. If the temperature rises further, the camera will turn off automatically.
- When using a Four Thirds system lens, the AF will not operate while recording movies.
- The  button cannot be used to record movies in the following instances:
 - While shutter the button is pressed halfway; during bulb, time, composite, sequential or time lapse photography; or when e-portrait, handheld starlight, panorama, or backlight HDR is selected in **SCN** mode or keystone compensation, panorama, live time, multiple exposure, or HDR is selected in **AP** mode
- A beep does not sound when the camera focuses in movie mode.

Notes

- Some settings, such as AF mode, can be set separately for movies and photographs.
 -  "Using the Video Menu" (P. 119)

Recording movies in movie mode

Movie mode can be used to create movies that take advantage of the effects available in photo shooting modes.

- Effects can be added to movies in the same way as photographs. “Adding effects to a movie” (P. 87)

1 Rotate the mode dial to .

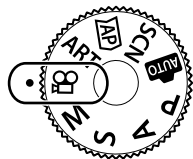

2 Use to highlight movie mode (P. 60).

- Some modes offer additional options that can be accessed using .



3 Press the button to select the highlighted mode.

- Press the button to choose a different movie mode. If additional options are displayed, press .

4 Press the button to begin recording.

- Be sure that [REC] is assigned to the button (P. 97).
- Press the button again to end recording.
- The sound level during recording is shown by the recording level meter. The more the meter extends into the red, the higher the recording level.
- The recording level can be adjusted from the video menu. [Recording Volume] (P. 119)

Recording level meter







- A beep does not sound when the camera focuses in movie mode.

Notes

- You can prevent the camera from recording operating sounds that occur due to camera operations while shooting. “Using the silencing function when shooting a movie” (P. 66)
- Touch controls can also be used.

Movie Mode Options

| Movie mode | Description |  |
|---|---|---|
|  Standard | Shoot standard movies, or shoot movies with selected effects. | 61 |
|  4K | Shoot 4K movies. | — |
|  Clips | Create a single movie file including multiple short movies. | 63 |
|  High-speed | Record slow-motion movies. Sound will not be recorded. | 66 |

- The picture modes available vary with the movie mode.
- Use UHS-I memory card with a UHS Speed Class of 3 when shooting in [4K] or [High-speed] mode.
- Use a memory card with a Speed Class of 10 or better when shooting in [Standard] or [Clips] mode.
- Depending on the system, some computers may be unable to play movies recorded at [4K]. See the OLYMPUS website for information on the system requirements for viewing 4K movies on a computer.





Movie Effects

A variety of effects can be added to movies. You can also zoom in on a selected area of the frame without zooming the lens.

- 1 Highlight [Standard] in the movie mode option (P. 60) and press the **OK** button.
 - Use live controls to choose from a movie quality (frame size and rate) options (P. 84).
- 2 Press the **REC** button to begin recording.
- 3 Tap the on-screen icon of the effect you wish to use.
 - Tap the display to add effects during shooting.
 - Some effects can be added by tapping the display before starting recording.



Movie effect

| Movie effect | Description |
|---|--|
|  Art Fade | Films with the selected picture mode effect. The fade effect is applied to the transition between scenes. |
|  Old Film | Randomly applies damage and dust-like noise similar to old movies. |
|  Multi Echo | Applies an after-image effect. After-images will appear behind moving objects. |
|  One Shot Echo | A ghost of the image displayed when the icon is tapped persists for a short while, disappearing with the passage of time. |
|  Movie Tele-converter | Zooms in on an area of the image without using the lens zoom. The selected position of the image can be zoomed in even while the camera is kept fixed. |

- 4 Press the **REC** button again to end recording.
 - The **INFO** button also controls the display of shooting information during movie recording. Note, however, that pressing the **INFO** button during recording cancels all movie effects except art fade and movie tele-converter.

■ Art Fade

Tap the icon. The effect will be applied gradually when you tap the icon of a picture mode.

- Movies shot in partial color use the color selected in **ART** mode.

■ Old Film

Tap the icon for the effect to be applied. Tap again to cancel the effect.

■ Multi Echo

Tap the icon for the effect to be applied. Tap again to cancel the effect.

■ One Shot Echo

Each tap of the icon adds the effect.

■ Movie Tele-converter

1 Tap the icon to display the zoom frame.

- You can change the position of the zoom frame by tapping the screen or using $\Delta \nabla \triangleleft \triangleright$.
- Press and hold the OK button to return the zoom frame to a central position.



2 Tap Zoom In to zoom in on the area in the zoom frame.

- Tap Zoom Out to return to the zoom frame display.

3 Tap Off or press the OK button to cancel the zoom frame and exit Movie Tele-converter mode.

- Movie Tele-converter is not available in self-portrait mode.
- The 2 effects cannot be applied simultaneously.
- Some effects may not be available depending on the picture mode.
- The frame rate may drop if an art filter or a movie effect is used.

Creating Movies from Clips

You can create a single movie file including multiple short movies (clips). Clips can be split into multiple groups ("My Clips"). You can also add still pictures to the My Clips movie (P. 109).

Recording Clips

- 1 Highlight [Clips] in the movie mode option (P. 60).
- 2 Press ∇ , use $\triangleleft \triangleright$ to choose the clip length, and press the \odot button.
 - Use live controls to choose from a movie quality (frame size and rate) options (P. 84).
- 3 Press the \odot button to start shooting.
 - Shooting ends automatically when the selected recording time is reached.
 - To extend the recording time, press the \odot button during recording. Recording time can be extended by up to 16 seconds by pressing the button repeatedly.
 - The new clip is added to My Clips.

| | |
|----------------|---|
| \triangle | Plays back My Clips from the beginning. |
| ∇ | Changes My Clips to save the clip to and the position to add the clip to. Use $\triangleleft \triangleright$ to change the position to add the clip to in the My Clips. |
| \odot | Prepare to record the next clip. |
| trash | Deletes the shot clip. |



- 4 Press the \odot button to shoot the next clip.
 - The confirmation screen will disappear and shooting of the next clip will start.
 - The new clip is added to the same My Clips group as the previous clip.
 - Movies recorded at different frame sizes or rates are saved to different My Clips groups.

Creating new My Clips

Press ∇ in Step 3.

Use $\triangle \nabla$ to move the clip to trash and press the \odot button.

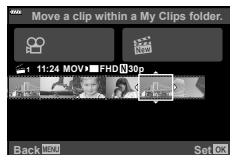

Removing a clip from My Clips

Press ∇ in Step 3.

Move a clip to \square using $\Delta \nabla \triangleleft \triangleright$, and press the \odot button.

- The clip removed from My Clips will be a normal movie file.
- Clips can be removed during playback. \mathbb{I} “Removing clips from My Clips” (P. 109)

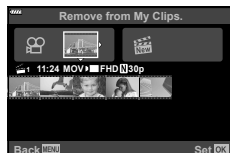

Tips

- Clips that have been removed can be added to My Clips again. \mathbb{I} “Adding still pictures to My Clips” (P. 109)

Editing “My Clips”

You can create a single movie file from My Clips.

The shot clips are stored in My Clips. You can add movie clips and still pictures to My Clips (P. 109). You can also add screen transition effects and art filter effects.

1 Press \square and then press \mathbb{I} button repeatedly to play back My Clips.

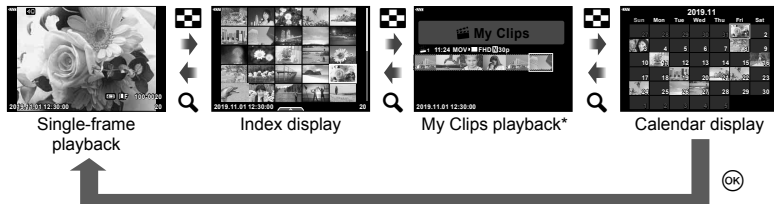

* If one or more My Clips have been created, it will be displayed here. After pressing the \square button, you can also view the My Clips playback display by highlighting an item marked with \mathbb{I} , pressing the \odot button, and selecting [See all My Clips] from the menu that appears.

2 Use $\Delta \nabla$ to select My Clips and $\triangleleft \triangleright$ to select a clip, and press the \odot button.

- The clip menu will be displayed.

| | |
|-----------------------------|--|
| Play My Clips | Plays back the files in My Clips in order, starting from the beginning. |
| Play Movie | Plays back the selected clips as movie. |
| Export My Clips | Exports the files in My Clips as a movie file. |
| Rearrange Order | Moves or adds files in My Clips. |
| Preset Destination | From the next time you shoot, movies shot in the same settings will be added to this \mathbb{I} My Clips. |
| Remove from My Clips | Removes the selected clip from My Clips. The clip is then treated as a normal movie file. \mathbb{I} “Removing clips from My Clips” (P. 109) |

3 With the My Clips you want for the movie selected, highlight [Export My Clips] and press the **OK** button.

4 Select an item using **△▽** and press the **OK** button.

| | |
|-----------------------------|--|
| Clip Effects | You can apply 6 types of art effects. |
| Transition Effect | You can apply fade effects. |
| BGM | You can set [Happy Days] or [Off]. |
| Recorded Clip Volume | When [BGM] is set to [Happy Days], you can set a volume for sounds recorded in the movie. |
| Recorded Clip Sound | By setting to [On], you can create a movie with the recorded sound. This setting is only available when [BGM] is set to [Off]. |
| Preview | You can preview the files of the edited My Clips in order, starting from the first file. |

5 When you have finished the editing, select [Begin Export] and press the **OK** button.

- The combined album is saved as a single movie.
- Exporting a movie may take some time.
- The maximum length for My Clips is 15 minutes and the maximum file size is 4 GB.
- It may take a while for My Clips to display after taking out, inserting, erasing, or protecting the card.
- You can record a maximum of 99 My Clips and a maximum of 99 cuts per clip. The maximum values may vary depending on the file size and length of My Clips.
- You cannot add movies other than clips to My Clips.

BGM other than [Happy Days]

To use BGM other than [Happy Days], record data that you have downloaded from the Olympus website onto the card and select it as [BGM] in Step 4. Visit the following website for the download.

<http://support.olympus-imaging.com/bgmdownload/>

Recording Slow Motion Movies

Record slow-motion movies. Footage shot at 120 fps plays back at 30 fps; quality is equivalent to [HD].

- 1 Highlight [High-speed] in the movie mode option (P. 60) and press the **OK** button.
- 2 Press the **⊙** button to start shooting.
 - Press the **⊙** button again to end shooting.
 - Focus and exposure are fixed at the start of recording.
 - Recording can continue for up to 20 seconds.
 - Sound will not be recorded.

Using the silencing function when shooting a movie

You can prevent the camera from recording operating sounds that occur due to camera operations while shooting.

Tap the silent shooting tab to display the function items.

After tapping an item, tap the displayed arrows to select the settings.

- Electronic zoom*, recording volume, aperture, shutter speed, exposure compensation, ISO sensitivity
 - * Only available with power zoom lenses
- The options available vary with the shooting mode.
- This option is not available in self-portrait mode (P. 67).

Silent shooting tab



Taking Photos in Self-Portrait Mode

Inverting the monitor allows you to take pictures of yourself while you preview the frame.

- 1 Push the monitor down slightly and swing it downward.

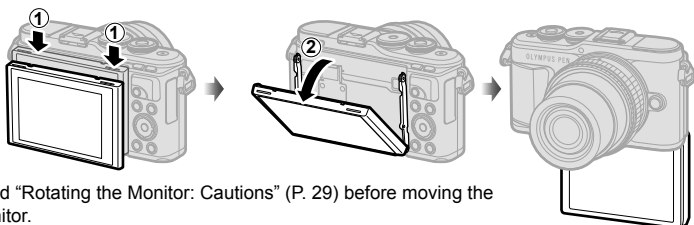

Read "Rotating the Monitor: Cautions" (P. 29) before moving the monitor.

- If a power zoom lens is attached, the camera automatically switches to wide angle.
- The self portrait menu is displayed in the monitor.
- Different icons may be displayed depending on the shooting mode.





| | | |
|--|--|--|
| | Shutter Touch | When the icon is touched, the shutter is released about 1 second later. |
| | Movie | When you touch this icon, movie recording will start. To stop recording, press the icon. While recording a clip, touch again to extend the recording time (up to a maximum of 16 seconds). |
| | Playback | Tap to switch to playback mode (P. 112). |
| | One-Touch e-Portrait | Turning this on makes skin look smooth and translucent. |
| | One-Touch Custom Self Timer | Shoot 3 frames using the self timer. You can set the number of times the shutter is released and the interval between each release using Custom Self Timer. "Custom Self-timer" (P. 74) |
| | Brightness adjustment (Exposure compensation) | Touch [+] or [-] icon to adjust the brightness. |

- 2 Frame the shot.
 - Be careful that your fingers or the camera strap do not obstruct the lens.
 - 3 Touch  and shoot.
 - You can also shoot by touching the subject displayed in the monitor, or by pressing the shutter button.
 - The shot image will be displayed on the monitor.
- Be careful not to drop the camera when using the touch screen with the camera held in one hand.



Controlling exposure (Exposure)

Choose positive (“+”) values to make pictures brighter, negative (“-”) values to make pictures darker. Exposure can be adjusted by ± 5.0 EV.





- In mode **P**, **ART** mode, movie mode, and some **AP** modes, exposure compensation can be adjusted by rotating the control dial or by pressing the  (Δ) button and then using $\triangleleft \triangleright$.
- In modes **A** and **S**, exposure compensation can be adjusted by pressing the  (Δ) button and then rotating the control dial or using $\triangleleft \triangleright$.
- Exposure compensation is not available in **Q**, **M**, or **SCN** mode or when Live Time or panorama is selected in **AP** mode.
- During live view, the brightness of the monitor will be adjusted to a maximum of only ± 3.0 EV. If the exposure exceeds ± 3.0 EV, the exposure bar will begin flashing.
- Movies can be corrected in a range up to ± 3.0 EV.

Notes

- The role of the control dial can be changed in the  custom menus.  [Dial Function] (P. 126)

Digital Zoom (Digital Tele-converter)

Press the **Fn** button to zoom in beyond the current zoom ratio. The display zoom ratio will double and any photographs taken will show the area visible in the monitor.

-  is displayed on the monitor.
- If another role is assigned to the **Fn** button, choose [] (P. 97).
- To exit digital zoom, press the **Fn** button again.
- Digital zoom is not available when panorama is selected in **SCN** mode, multiple exposure, panorama, or keystone compensation is selected in **AP** mode or when [Standard] is selected in movie mode.
- When a RAW image is displayed, the area visible in the monitor is indicated by a frame.
- AF target drops.

Selecting the AF target mode (AF target settings)

You can choose the position and size of the focus area for autofocus. You can also select Face priority AF (P. 71).

- 1 Press the **[⋮]** (<) button.
- 2 Select **[▪]** (Single Target) or **[⋮]** (9-Target Group) using the control dial.

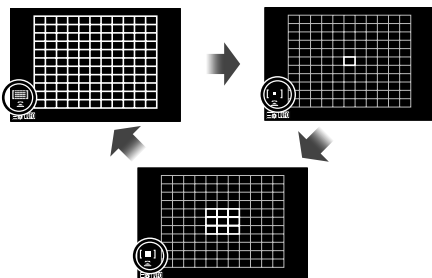

| | |
|---------------------------|--|
| [⋮] All Targets | The camera automatically chooses from the full set of focus targets. |
| [▪] Single Target | You can choose a single AF target. |
| [⋮] 9-Target Group | The camera automatically chooses from the targets in the selected nine-target group. |

- The single target mode is automatically applied in movie shooting if the group target mode is set.
- When using a Four Thirds system lens, the camera automatically switches to single target mode.

Notes

- You can also make your selection in Step 2 by pressing the **INFO** button and then using **△▽**.

Setting the AF target

Select the single target or group target position.

- 1 Press the **[⋮]** (<) button.
 - If **[⋮]** (All Targets) is selected, select **[▪]** (Single Target) or **[⋮]** (9-Target Group) using the control dial.
- 2 Use **△▽<>** to choose a focus area.
 - The size and number of the AF targets changes with the aspect ratio (P. 83) and the option selected for [Digital Tele-converter] (P. 115).

Notes

- You can also make your selection in Step 2 by pressing the **INFO** button and then using the control dial.
- Touch controls can also be used.

Face priority AF/Eye priority AF

The camera detects faces and adjusts focus and digital ESP.

- 1 Press the **[AF-ON]** (**<L>**) button.
- 2 Press the **INFO** button.
 - You can adjust face and eye priority settings.
- 3 Use **<R>** to select an option and press **OK**.

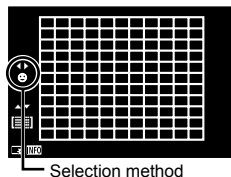

| | | |
|--|-----------------------------------|--|
| | Face Priority On | Face priority is on. |
| | Face Priority Off | Face priority is off. |
| | Face & Eye Priority On | The autofocus system selects the eye closest to the camera for face-priority AF. |

- 4 Point the camera at your subject.
 - If a face is detected, it will be indicated by a white frame.
- 5 Press the shutter button halfway to focus.
 - When the camera focuses on the face in the white frame, the frame will turn green.
 - If the camera is able to detect the subject's eyes, it will display a green frame over the selected eye. (eye priority AF)
- 6 Press the shutter button the rest of the way down to shoot.

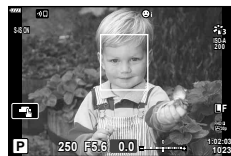

- During sequential shooting, face priority applies only to the first shot in each sequence.
- Depending on the subject and the art filter setting, the camera may not be able to correctly detect the face.
- When set to **[ESP]** (Digital ESP metering) (P. 91), metering is performed with priority given to faces.

Notes

- Face priority is also available in **[MF]** (P. 81). Faces detected by the camera are indicated by white frames.

Using a flash (Flash photography)

The flash can be used for flash photography in a variety of shooting conditions.

- 1 Press the flash pop-up button to raise the flash.

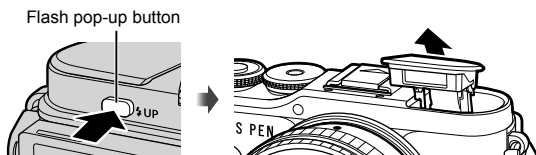

- 2 Press the (▶) button.
- 3 Select an item using the control dial and press the button.
 - The options available and the order in which they are displayed vary depending on the shooting mode. "Flash modes that can be set by shooting mode" (P. 73)

| | | |
|--|---|--|
| | Fill In | The flash fires. |
| | Redeye | The flash fires so that the red-eye phenomenon is reduced. |
| | Flash Off | The flash does not fire. |
| | Red-Eye Slow Synchronization (1st curtain/Red-eye reduction flash) | The slow synchronization is combined with the red-eye reduction flash. |
| | Slow Synchronization (1st curtain) | The flash fires with slow shutter speeds to brighten dimly-lit backgrounds. |
| | Slow2 Synchronization (2nd curtain) | The flash fires immediately before the shutter closes to create trails of light behind moving light sources. |
| | Manual Value etc. | For users who prefer manual operation. Press the INFO button and use to adjust flash output. |

- In (Redeye)], after the pre-flashes, it takes about 1 second before the shutter is released. Do not move the camera until shooting is complete.
- (Redeye)] may not work effectively under some shooting conditions.
- When the flash fires, the shutter speed is set to 1/250 seconds or slower. When shooting a subject against a bright background with the flash, the background may be overexposed.
- The flash sync speed for the silent mode (P. 75) is 1/20 seconds or less.

Optional Flash Units

When using optional flash units, be sure the built-in flash has been securely restored to its housing.

Flash modes that can be set by shooting mode

| Shooting mode | Monitor | Flash mode | Flash timing | Conditions for firing the flash | Shutter speed limit |
|---------------|---------|---|--------------|---------------------------------|-------------------------|
| P/A | | Fill In | 1st curtain | Always fires | 30 sec. – 1/250 sec.* |
| | | Redeye | | | 1/30 sec. – 1/250 sec.* |
| | | Flash Off | — | — | — |
| | | Red-Eye Slow Slow synchronization (1st curtain/ Red-eye reduction flash) | 1st curtain | Always fires | 60 sec. – 1/250 sec.* |
| | | Slow Slow synchronization (1st curtain) | | | |
| | | Slow2 Slow synchronization (2nd curtain) | 2nd curtain | | |
| SM | | Fill In | 1st curtain | Always fires | 60 sec. – 1/250 sec.* |
| | | Redeye | | | |
| | | Flash Off | — | — | — |
| | | Slow2 Slow synchronization (2nd curtain) | 2nd curtain | Always fires | 60 sec. – 1/250 sec.* |

• Only and can be set in **AUTO** mode.

* The shutter speed is 1/200 seconds when using a separately sold external flash. For the silent mode, the shutter speed is 1/20 seconds.

Minimum range

The lens may cast shadows over objects close to the camera, causing vignetting, or the flash may be too bright even at minimum output.

| Lens | Approximate distance at which vignetting occurs |
|------------------------|---|
| 17mm f1.8 | 0.25 m |
| 25mm f1.8 | 0.25 m |
| 45mm f1.8 | 0.5 m |
| ED 14-42mm f3.5-5.6 EZ | 1 m |
| ED 40-150mm f4.0-5.6 | 0.9 m |

• External flash units can be used to prevent vignetting. To prevent photographs from being overexposed, select **A** or **M** mode, and choose a high aperture value or reduce ISO sensitivity.

Performing the sequential/self-timer shooting

You can take a series of pictures by keeping the shutter button pressed all the way down. Alternatively, you can take pictures using the self-timer.

- 1 Press the (∇) button.
- 2 Highlight one of the following options using .

| | | |
|-----------------------------------|--------------------------|---|
| / ◆ / ▼ | Single | 1 frame is taken at a time when the shutter button is pressed. |
| / ▼ | Sequential High | With , pictures are taken at up to about 8.6 frames per second (fps) while the shutter button is pressed all the way down. With ▼ , pictures are taken at up to about 14.1 fps. Focus, exposure, and white balance are fixed at the values for the first shot in each series. |
| / ◆ / ▼ | Sequential Low | Pictures are taken at up to about 4.8 frames per second (fps) while the shutter button is pressed all the way down. Focus and exposure are fixed according to the options selected for [AF Mode] (P. 81) and [AEL/AFL] (P. 131). |
| 12s/ ◆ 12s/ 12 sec ▼ 12s | | Press the shutter button halfway to focus, the rest of the way down to start the timer. First, the self-timer lamp lights up for approximately 10 seconds, then it blinks for approximately 2 seconds and the picture is taken. |
| 2s/ ◆ 2s/ 2 sec ▼ 2s | | Press the shutter button halfway to focus, the rest of the way down to start the timer. The self-timer lamp blinks for approximately 2 seconds, and then the picture is taken. |
| C/ ◆ C/ ▼ C | Custom Self-timer | Press the INFO button to set [Timer], [Number of Frames], and [Interval Length]. Use to highlight items and to choose a value. |

Items marked with ◆ use the electronic shutter to control the small amount of camera blur caused by operation of the shutter.

Items marked with ▼ use the electronic shutter. Use these with shutter speeds faster than 1/4000 seconds, or in settings where the sound of the shutter would be unwelcome.

- 3 Press the button.

- Fix the camera securely on a tripod for self-timer shooting.
- If you stand in front of the camera to press the shutter button when using the self-timer, the picture may be out of focus.
- When you are using , ◆ , or ▼ , live view is displayed. In or ▼ , the display shows the last photograph taken during the sequential shooting.
- The speed of sequential shooting varies depending on the lens you are using and the focus of the zoom lens.
- During sequential shooting, if the battery level icon blinks due to low battery, the camera stops shooting and starts saving the pictures you have taken on the card. The camera may not save all of the pictures depending on how much battery power remains.

Notes

- To cancel the activated self-timer, press .

The Electronic Shutter (Silent [♥])

Take pictures using the electronic shutter. Use for shutter speeds faster than 1/4000 s or in settings where the sound of the shutter would be unwelcome. The electronic shutter can be used in single-frame mode and self-timer modes and for frame rates as high as about 14.1 fps in sequential shooting modes. This setting is only available in **P/A/S/M/ART** modes.

- The flash sync speed is 1/20 s.
- To use the flash in [Silent [♥]] mode, select [Allow] for [Silent [♥] Settings] > [Flash Mode] (P. 117).

1 Press the   () button.

2 Highlight one of the options marked with ♥ using  .

3 Press the  button.

- When the shutter is released, the monitor screen will go dark for a moment. No shutter sound will be emitted.
- The desired results may not be achieved under flickering light sources such as fluorescent or LED lamps or if the subject moves abruptly during shooting.
- Note that due to the electronic shutter, the subject may appear to be distorted in photographs if camera moves quickly during shooting or when shooting fast-moving subjects.

Calling shooting options

■ Live control

You can use live control to select the shooting function while checking the effect on the screen.



■ Available settings

| | |
|-----------------------|-------|
| Picture mode | P. 78 |
| ISO sensitivity | P. 79 |
| White balance | P. 80 |
| AF mode | P. 81 |
| Aspect ratio*1 | P. 83 |

| | | |
|-----------------------------|-------|-------|
| [Camera icon] | | P. 83 |
| [Zoom icon] | | P. 84 |
| Movie (exposure) mode | P. 87 | |
| Scene mode*2 | P. 33 | |
| Art filter mode*3 | P. 47 | |

*1 Not available in movie mode.

*2 Available in **SCN** mode.

*3 Available in **ART** mode and with some **P/A/S/M** mode features.

- 1 Press **OK** to display the live control.
 - To hide the live control, press **OK** again.

- 2 Use **Δ**/**∇** to highlight the desired function and **◀**/**▶** to highlight a setting, and then press the **OK** button.

- You can use the control dial to select a setting.
- The selected settings take effect automatically if no operations are performed for about 8 seconds.

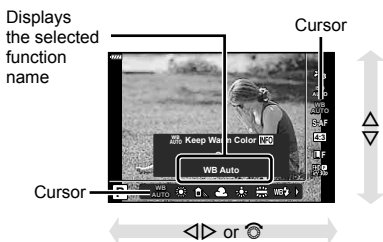

- Some items are not available in some shooting modes.

Notes

- For the default settings of each option, refer to “Defaults” (P. 162).

■ LV super control panel

Other shooting options can be accessed via the LV super control panel, which lists the options selected for the following shooting settings.

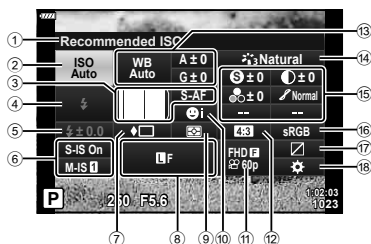

Settings that can be modified using LV super control panel

- | | |
|---|--|
| ① Currently selected option | ⑭ Picture mode..... P. 78 |
| ② ISO sensitivity..... P. 79 | ⑮ Sharpness S^*1 P. 91 |
| ③ AF mode..... P. 81 | Contrast C^*1 P. 92 |
| AF target..... P. 70 | Saturation S^*1 P. 92 |
| ④ Flash mode..... P. 72 | Gradation G^*1 P. 93 |
| ⑤ Flash intensity control..... P. 88 | Color filter F^*1 P. 93 |
| ⑥ Image stabilizer..... P. 89 | Monochrome color M^*1 P. 94 |
| ⑦ Sequential shooting/Self-timer..... P. 74 | Effect E^*1 P. 94 |
| ⑧ AF \leftarrow P. 83 | Color C^*1*2 P. 50 |
| ⑨ Metering mode..... P. 91 | Color/Vivid C^*1*3 P. 78 |
| ⑩ Face priority..... P. 71 | Fine-Tune *1 P. 78 |
| ⑪ AF \leftarrow P. 84 | ⑯ Color space..... P. 95 |
| ⑫ Aspect ratio..... P. 83 | ⑰ Highlight & shadow control..... P. 96 |
| ⑬ White balance..... P. 80 | ⑱ Button function assignment..... P. 97 |
| White balance compensation..... P. 90 | |

*1 The display may differ when Art Filter is selected for picture mode.

*2 Displayed when Partial Color is set.

*3 Displayed when Color Creator is set.

1 Press the P/A/S/M button in **P/A/S/M** modes.

- The LV super control panel will be displayed.
- In **Auto**, **ART**, **SCN**, and **AP** modes, the display of the LV super control panel is controlled via [Camera Control Settings] (P. 127).
- The LV super control panel is not displayed in movie mode.

2 Highlight an item using Δ ∇ \leftarrow \rightarrow and press the OK button.

3 Use \leftarrow \rightarrow to highlight an option.

Notes

- Settings can also be adjusted using the control dial or touch controls.
- For the default settings of each option, refer to "Defaults" (P. 162).

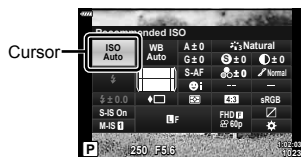

Processing options (Picture Mode)

You can select a picture mode and make individual adjustments to contrast, sharpness, and other parameters (P. 91–94). Changes to each picture mode are stored separately.

- 1 Press the **OK** button and use Δ ∇ to highlight Picture Mode.
- 2 Highlight an option using \triangleleft \triangleright and press the **OK** button.



Picture Mode

Picture mode options

| | |
|-----------------------------------|---|
| i-Enhance | Produces more impressive-looking results suited to the scene. |
| Vivid | Produces vivid colors. |
| Natural | Produces natural colors. |
| Muted | Produces flat tones. |
| Portrait | Produces beautiful skin tones. |
| Monochrome | Produces black and white tone. |
| Custom | Use to select one picture mode, set the parameters, and register the setting. |
| e-Portrait | Produces smooth skin textures. This mode cannot be used with bracket photography or when shooting movies. |
| Color Creator*1 | Provides a color finish set in Color Creator. |
| ART 1 Pop Art*2 | Uses Art Filter settings. Art effects can also be used. |
| ART 2 Soft Focus*2 | |
| ART 3 Pale&Light Color | |
| ART 4 Light Tone | |
| ART 5 Grainy Film | |
| ART 6 Pin Hole | |
| ART 7 Diorama | |
| ART 8 Cross Process | |
| ART 9 Gentle Sepia | |
| ART 10 Dramatic Tone | |
| ART 11 Key Line | |
| ART 12 Watercolor | |
| ART 13 Vintage | |
| ART 14 Partial Color*3 | |
| ART 15 Bleach Bypass | |
| ART 16 Instant Film | |

*1 After choosing Color Creator using the \triangleleft \triangleright buttons, press the **INFO** button and use the control dial or \triangleleft \triangleright to adjust hue and Δ ∇ to adjust saturation.

*2 After choosing Pop Art I or Soft Focus using the \triangleleft \triangleright buttons, press the **INFO** button to display the slider for Fine Tuning (P. 50).

*3 After choosing Partial Color using \triangleleft \triangleright , press the **INFO** button to display the color ring (P. 50).

Changing ISO sensitivity (ISO)

Increasing ISO sensitivity increases noise (graininess) but allows photographs to be taken when lighting is poor. The setting recommended in most situations is [AUTO], which starts at ISO 200—a value that balances noise and dynamic range—and then adjusts ISO sensitivity according to shooting conditions.

- 1 Press the **OK** button and then highlight ISO sensitivity using **Δ** **▽**.
- 2 Highlight an option using **◀▶** and press the **OK** button.

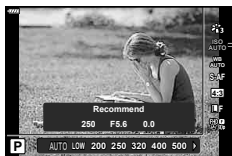

ISO

| | |
|-----------------------|--|
| AUTO | The sensitivity is set automatically according to the shooting conditions. The maximum ISO sensitivity value and other auto ISO settings can be adjusted using the [ISO-Auto Set] option in custom menus (P. 128). |
| LOW, 200–25600 | The sensitivity is set to the selected value. |

Adjusting color (WB (white balance))

White balance (WB) ensures that white objects in images recorded by the camera appear white. [AUTO] is suitable in most circumstances, but other values can be selected according to the light source when [AUTO] fails to produce the desired results or you wish to introduce a deliberate color cast into your images.

- 1 Press the **OK** button and use Δ ∇ to highlight White Balance.
- 2 Highlight an option using \triangleleft \triangleright and press the **OK** button.



White Balance

| WB mode | | Color temperature | Light conditions |
|-------------------------|-----------------|---------------------------------------|--|
| Auto white balance | AUTO | — | For most light conditions (when there is a white portion framed on the monitor). Use this mode for general use. <ul style="list-style-type: none"> When this option is highlighted, you can press the INFO button and use Δ ∇ \triangleleft \triangleright or the control dial to select [On] or [Off] for [WB Auto Keep Warm Color] (P. 129). |
| Preset white balance | | 5300 K | For shooting outdoors on a clear day, or to capture the reds in a sunset or the colors in a fireworks display |
| | | 7500 K | For shooting outdoors in the shadows on a clear day |
| | | 6000 K | For shooting outdoors on a cloudy day |
| | | 3000 K | For shooting under a tungsten light |
| | | 4000 K | For shooting under a fluorescent light |
| | | 5500 K | For flash shooting |
| One-touch white balance | / / / | Color temperature set by one-touch WB | Press the INFO button to measure white balance using a white or gray target when using a flash or other light source of an unknown type or when shooting under mixed lighting. “One-touch white balance” (P. 81) |
| Custom white balance | CWB | 2000 K–14000 K | After pressing the INFO button, use Δ ∇ \triangleleft \triangleright to select a color temperature and then press the OK button. |

One-touch white balance

Measure white balance by framing a piece of paper or other white object under the lighting that will be used in the final photograph. This is useful when shooting a subject under natural light, as well as under various light sources with different color temperatures.

- 1 Select [W1], [W2], [W3], or [W4] (one-touch white balance 1, 2, 3, or 4) and press the **INFO** button.
- 2 Photograph a piece of colorless (white or gray) paper.
 - Frame the paper so that it fills the display and no shadows fall it.
 - The one-touch white balance screen appears.
- 3 Select [Yes] and press the **OK** button.
 - The new value is saved as a preset white balance option.
 - The new value is stored until one-touch white balance is measured again. Turning the power off does not erase the data.

Choosing a focus mode (AF Mode)

You can select a focusing method (focus mode). You can choose separate focusing methods for still photography mode and movie mode.

- 1 Press the **OK** button and use Δ ∇ to highlight AF Mode.



AF Mode

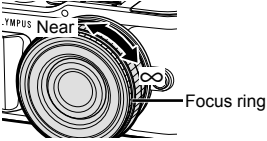

- 2 Highlight an option using \leftarrow \rightarrow and press the **OK** button.

| | |
|--------------------------------|---|
| S-AF (Single AF) | The camera focuses once when the shutter button is pressed halfway. When the focus is locked, a beep sounds, and the AF confirmation mark and the AF target mark light up. This mode is suitable for taking pictures of still subjects or subjects with limited movement. |
| C-AF (Continuous AF) | The camera repeats focusing while the shutter button remains pressed halfway. When the subject is in focus, the AF confirmation mark lights up on the monitor and the beep sounds when the focus is locked at the first time. Even if the subject moves or you change the composition of the picture, the camera continues trying to focus. |
| MF (Manual focus) | This function allows you to manually focus on any position by operating the focus ring on the lens.  |

| | |
|---|---|
| S-AF+MF (Simultaneous use of S-AF mode and MF mode) | After pressing the shutter button halfway to focus in [S-AF] mode, you can turn the focus ring to fine-adjust focus manually. |
| C-AF+TR (AF tracking) | Press the shutter button halfway to focus; the camera then tracks and maintains focus on the current subject while the shutter button is held in this position. <ul style="list-style-type: none"> • The AF target is displayed in red if the camera can no longer track the subject. Release the shutter button and then frame the subject again and press the shutter button halfway. • Tracking range will be narrow when using a Four Thirds system lens. Autofocus does not work while the AF target is displayed in red even if the camera is tracking the subject. |

- The camera may be unable to focus if the subject is poorly lit, obscured by mist or smoke, or lacks contrast.
- When using a Four Thirds system lens, AF will not be available during movie recording.
- AF mode is unavailable when the lens MF focus clutch is set to MF.
- If [MF], [C-AF], or [C-AF+TR] is selected in **P**, **A**, **S**, **M**,  or **ART** mode, the shutter can be released even when the camera is not focus.

Notes

- The focus method can be chosen in the  custom menu.  "AEL/AFL" (P. 131)

Setting the image aspect

You can change the aspect ratio (horizontal-to-vertical ratio) when taking pictures. Depending on your preference, you can set the aspect ratio to [4:3] (standard), [16:9], [3:2], [1:1], or [3:4].

- 1 Press the **OK** button and use **Δ** **▽** to highlight Image Aspect.
- 2 Use **◀▶** to choose a value and press the **OK** button.



Image Aspect

- Image aspect can only be set for still images.
- JPEG images are recorded at the selected aspect ratio. RAW images are the same size as the image sensor and are recorded at an aspect ratio of 4:3 with a tag indicating the aspect ratio selected. A crop indicating the selected aspect ratio is displayed when images are played back.

Selecting image quality (Still image quality, **☺** **◀▶**)

You can set an image quality mode for still images. Select a quality suitable for the application (such as for processing on PC, use on website etc.).

- 1 Press the **OK** button and use **Δ** **▽** to highlight (Still image quality, **☺** **◀▶**).



Still Image Quality

- 2 Highlight an option using **◀▶** and press the **OK** button.
 - Choose from JPEG (**L**, **N**, **M**, and **S**) and RAW modes. Choose a JPEG+RAW option to record both a JPEG and a RAW image with each shot. JPEG modes combine image size (**L**, **M**, and **S**) and compression ratio (SF, F, and N).
 - When you want to select a combination other than **L**, **N**, **M**, and **S**, change the [**☺** Set] (P. 129) settings in Custom Menu.

RAW image data





RAW images consist of unprocessed image data to which settings such as exposure compensation and white balance have yet to be applied. They serve as raw data for images that will be processed after shooting. RAW image files:

- Have the extension “.orf”
- Cannot be viewed on other cameras
- Can be viewed on computers using Olympus Workspace photo editing software
- Can be saved in JPEG format using the [RAW Data Edit] (P. 120) retouch option in the camera menus

☺ “Editing still images (Edit)” (P. 120)

Selecting image quality (Movie quality,)

You can set a movie record mode suitable for the desired use.

- 1 Press the  button and use Δ ∇ to highlight (Movie quality,  .
- 2 Use \triangleleft \triangleright to choose a value and press the  button.

















Movie Quality











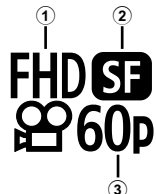

■ Available Movie Quality Options

The options available for movie quality vary with the movie mode (P. 60) and the options selected for [Video Frame Rate] and [Video Bit Rate] in the video menu (P. 119).

- When shooting movies that will be viewed on a television, choose a frame rate that matches the video standard used in the device, as otherwise the movie may not play back smoothly. Video standards vary by country or region: some use NTSC, others PAL.
 - When shooting for display on NTSC devices, choose 60p (30p)
 - When shooting for display on PAL devices, choose 50p (25p)



The following options are available when [Standard] is selected for movie mode or the mode dial is rotated to a position other than :

| Movie quality | Movie quality components |
|--|---|
|  1920×1080 Super Fine 60p | Choose the desired combination of frame size, bit rate, and frame rate.  ① Frame size FHD : 1920×1080 HD : 1280×720 ② Bit rate (compression ratio) SF (Super Fine), F (Fine), N (Normal) ③ Frame rate 30p (60p), 25p (50p), 24p |
|  1920×1080 Super Fine 30p | |
|  1280×720 Super Fine 30p | |
|  1920×1080 Fine 60p | |
|  1920×1080 Fine 30p | |
|  1280×720 Fine 30p | |
|  1920×1080 Normal 60p | |
|  1920×1080 Normal 30p | |
|  1280×720 Normal 30p | |
|  1920×1080 Super Fine 50p | |
|  1920×1080 Super Fine 25p | |
|  1280×720 Super Fine 25p | |

| Movie quality | Movie quality components |
|--|--|
|  1920×1080 Fine 50p | Choose the desired combination of frame size, bit rate, and frame rate.  |
|  1920×1080 Fine 25p | |
|  1280×720 Fine 25p | |
|  1920×1080 Normal 50p | |
|  1920×1080 Normal 25p | |
|  1280×720 Normal 25p | |
|  1920×1080 Super Fine 24p | |
|  1280×720 Super Fine 24p | |
|  1920×1080 Fine 24p | |
|  1280×720 Fine 24p | |
|  1920×1080 Normal 24p | |
|  1280×720 Normal 24p | |

- ① Frame size
 FHD : 1920×1080
 HD : 1280×720
- ② Bit rate (compression ratio)
 SF (Super Fine), F (Fine), N (Normal)
- ③ Frame rate
 30p (60p), 25p (50p), 24p

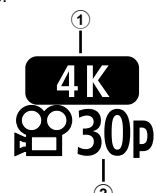







The following options are available when [4K] is selected for movie mode *1:

| Movie quality | Movie quality components |
|--|---|
|  3840×2160 30p | Choose the desired combination of frame size and frame rate.  |
|  3840×2160 25p | |
|  3840×2160 24p | |

- ① Frame size
 4K : 3840×2160
- ② Frame rate
 30p, 25p, 24p

*1 The bit rate can not be changed.

The following options are available when [Clips] is selected for movie mode *1:

| Movie quality | Movie quality components |
|--|--|
|  1920×1080 Normal 60p | Choose the desired combination of frame size, bit rate, and frame rate.  |
|  1920×1080 Normal 30p | |
|  1280×720 Normal 30p | |
|  1920×1080 Normal 50p | |
|  1920×1080 Normal 25p | |
|  1280×720 Normal 25p | |
|  1920×1080 Normal 24p | |
|  1280×720 Normal 24p | |



① Frame size
FHD : 1920×1080
HD : 1280×720

② Bit rate (compression ratio)
N (Normal)

③ Frame rate
30p (60p), 25p (50p), 24p

*1 The bit rate can not be changed.

The following option is available when [High-speed] is selected for movie mode *2:

| Movie quality | Movie quality components |
|---|---|
|  1280×720 HighSpeed 120fps |  |

① Frame size
HD : 1280×720



② Frame rate
120fps

*2 The frame rate and bit rate can not be changed.

- Movies are stored in MPEG-4 AVC/H.264 format. The maximum size of individual file is limited to 4 GB. The maximum recording time of individual movie is limited to 29 minutes.
- Depending on the type of card used, recording may end before the maximum length is reached.







Adding effects to a movie

You can create movies that take advantage of the effects available in still photography mode.

- 1 Rotate the mode dial to .
- 2 Press the  button and use Δ ∇ to highlight movie (exposure) mode.
- 3 Use \triangleleft \triangleright to choose a value and press the  button.





Movie (exposure) mode

| | |
|----------|---|
| P | Exposure is automatically adjusted in response to subject brightness. You can adjust the exposure by using the control dial. After pressing the  (Δ) button, you can also set it by using \triangleleft \triangleright . |
| A | Depiction of background is changed by setting the aperture. You can set the aperture by using the control dial. After pressing the  (Δ) button, you can also set it by using Δ ∇ . After pressing the  (Δ) button, you can adjust the exposure by using \triangleleft \triangleright . |
| S | Shutter speed affects how the subject appears. You can set the shutter speed by using the control dial. After pressing the  (Δ) button, you can also set it by using Δ ∇ . After pressing the  (Δ) button, you can adjust the exposure by using \triangleleft \triangleright . Shutter speed can be set to values between 1/24 s and 1/4000 s. |
| M | Aperture and shutter speed can be manually set. You can set the shutter speed by using the control dial. After pressing the  (Δ) button, you can also set it by using Δ ∇ . After pressing the  (Δ) button, you can set the aperture by using the control dial or \triangleleft \triangleright . Shutter speed can be set to values between 1/24 s and 1/4000 s. ISO sensitivity can only be set manually to values between 200 and 6400. |











- Blurred frames caused by such factors as the subject moving while the shutter is open can be reduced by selecting the fastest available shutter speed.
- The low end of the shutter speed changes according to the frame rate of the movie record mode.

Notes

- The role of the control dial can be changed in the  custom menus.  [Dial Function] (P. 126)

Adjusting flash output (Flash intensity control)

Flash output can be adjusted if you find that your subject appears overexposed, or is underexposed even though the exposure in the rest of the frame is just right.

- 1 Press the  button in **P/A/S/M** modes.
 - In **Auto**, **ART**, **SCN**, and **AP** modes, the display of the LV super control panel is controlled via  Control Settings] (P. 127).
- 2 Use     to select , then press the  button.
- 3 Use   to choose a value and press the  button.

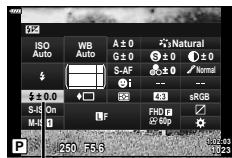

Flash intensity control

- This setting has no effect when the flash control mode for the external flash unit is set to **MANUAL**.
- Changes to flash intensity made with the external flash unit are added to those made with the camera.

Reducing camera shake (Image Stabilizer)

You can reduce the amount of camera shake that can occur when shooting in low light situations or shooting with high magnification.

The image stabilizer starts when you press the shutter button halfway.

- Press the  button in **P/A/S/M** modes.
 - In **Auto**, **ART**, **SCN**, and **AP** modes, the display of the LV super control panel is controlled via [Control Settings] (P. 127).
- Use Δ ∇ \langle \rangle to select [Image Stabilizer], then press the \odot button.
- Highlight an option using \langle \rangle and press the \odot button.

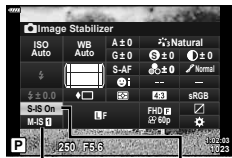

 Image Stabilizer

 Image Stabilizer

| | | |
|-------------------------|---------------|---|
| Still picture (S-IS) | S-IS Off | Image stabilizer is off. |
| | S-IS On | The camera detects the panning direction and applies the appropriate image stabilization. |
| Movie (M-IS) | M-IS Off | Image stabilizer is off. |
| | M-IS 1 | The camera uses both sensor shift (VCM) and electronic correction. |
| | M-IS 2 | The camera uses sensor shift (VCM) correction only. Electronic correction is not used. |

- The edges of the frame are cropped out when [M-IS **1**] is selected, reducing the area recorded.
- The image stabilizer cannot correct excessive camera shake or camera shake that occurs when the shutter speed is set to the slowest speed. In these cases, it is recommended that you use a tripod.
- When using a tripod, set [Image Stabilizer] to [S-IS Off]/[M-IS Off].
- When using a lens with an image stabilization function switch, priority is given to the lens side setting.
- You may notice an operating sound or vibration when the image stabilizer is activated.

Using lenses other than Micro Four Thirds/Four Thirds System lenses

You can use focal length information to reduce camera shake when shooting with lenses that are not Micro Four Thirds or Four Thirds system lenses.













- Press the **INFO** button while [Image Stabilizer] is selected, use Δ ∇ \langle \rangle to highlight a focal length, and press the \odot button.
- Choose a focal length between 0.1 mm and 1000.0 mm.
- Choose the value that matches the one printed on the lens.
- Selecting [Reset] (basic) in Shooting Menu 1 does not reset the focal length.

Making fine adjustments to white balance (WB Compensation)

You can set and finely adjust the compensation values for both auto white balance and preset white balance.

Before proceeding, choose a white balance option to which to make fine adjustments.

☞ “Adjusting color (WB (white balance))” (P. 80)

- 1 Press the  button in **P/A/S/M** modes.
 - In **Auto**, **ART**, **SCN**, and **AP** modes, the display of the LV super control panel is controlled via  Control Settings] (P. 127).
- 2 Highlight white balance compensation using     and press the  button.
- 3 Use   to choose an axis.
- 4 Choose a value using   and press the  button.

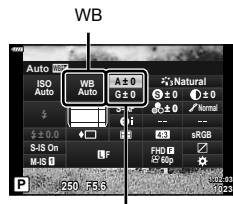

White balance compensation

For compensation on the A axis (Red-Blue)

Move the bar in the + direction to emphasize red tones and in the – direction to emphasize blue tones.











For compensation on the G axis (Green-Magenta)

Move the bar in the + direction to emphasize green tones and in the – direction to emphasize magenta tones.

- Selecting [Reset] (basic) in Shooting Menu 1 does not reset the values selected.









Choosing how the camera measures brightness (Metering)

You can choose how the camera meters subject brightness.

- Press the  button in **P/A/S/M** modes.
 - In **Auto**, **ART**, **SCN**, and **AP** modes, the display of the LV super control panel is controlled via [ Control Settings] (P. 127).
- Use     to select [Metering], then press the  button.
- Highlight an option using   and press the  button.













Metering

| | | |
|---|---|--|
|  | Digital ESP metering | Meters exposure in 324 areas of the frame and optimizes exposure for the current scene or portrait subject (if an option other than [OFF] is selected for [ Face Priority]). This mode is recommended for general use. |
|  | Center weighted averaging metering | Provides the average metering between the subject and the background lighting, placing more weight on the subject at the center.  |
|  | Spot metering | Meters a small area (about 2% of the frame) with the camera pointed at the object you wish to meter. Exposure will be adjusted according to the brightness at the metered point.  |
|  | Spot metering (highlight) | Increases spot metering exposure. Ensures bright subjects appear bright. |
|  | Spot metering (shadow) | Lowers spot metering exposure. Ensures dark subjects appear dark. |

Making fine adjustments to sharpness (Sharpness)

In the picture mode (P. 78) settings, you can make fine adjustments to sharpness and store the changes.

- Adjustments may not be available depending on the shooting mode.

- Press the  button in **P/A/S/M** modes.
 - In **Auto**, **ART**, **SCN**, and **AP** modes, the display of the LV super control panel is controlled via [ Control Settings] (P. 127).
- Use     to select [Sharpness], then press the  button.
- Adjust sharpness using   and press the  button.

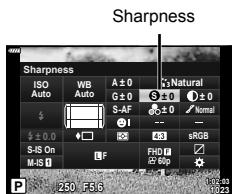

Sharpness

Making fine adjustments to contrast (Contrast)

In the picture mode (P. 78) settings, you can make fine adjustments to contrast and store the changes.

- Adjustments may not be available depending on the shooting mode.

- 1 Press the button in **P/A/S/M** modes.
 - In **Auto**, **ART**, **SCN**, and **AP** modes, the display of the LV super control panel is controlled via Control Settings] (P. 127).
- 2 Use Δ ∇ \langle \rangle to select [Contrast], then press the \odot button.
- 3 Adjust contrast using \langle \rangle and press the \odot button.

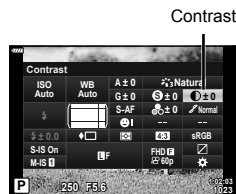

Making fine adjustments to saturation (Saturation)

In the picture mode (P. 78) settings, you can make fine adjustments to saturation and store the changes.

- Adjustments may not be available depending on the shooting mode.

- 1 Press the button in **P/A/S/M** modes.
 - In **Auto**, **ART**, **SCN**, and **AP** modes, the display of the LV super control panel is controlled via Control Settings] (P. 127).
- 2 Use Δ ∇ \langle \rangle to select [Saturation], then press the \odot button.
- 3 Adjust saturation using \langle \rangle and press the \odot button.

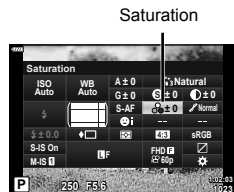

Making fine adjustments to tone (Gradation)

In the picture mode (P. 78) settings, you can make fine adjustments to tone and store the changes.

- Adjustments may not be available depending on the shooting mode.

- Press the button in **P/A/S/M** modes.
 - In **Auto**, **ART**, **SCN**, and **AP** modes, the display of the LV super control panel is controlled via [Control Settings] (P. 127).
- Use Δ ∇ \triangleleft \triangleright to select [Gradation], then press the \odot button.
- Adjust tone using \triangleleft \triangleright and press the \odot button.

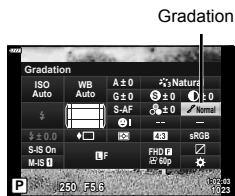

Gradation

2

Shooting

| | |
|---------------------------|---|
| Shadow Adj | Divides the image into detailed regions and adjusts the brightness separately for each region. This is effective for images with areas of large contrast in which the whites appear too bright or the blacks appear too dark. |
| Gradation Normal | Use the normal mode for general uses. |
| Gradation High Key | Uses a tone suitable for a bright subject. |
| Gradation Low Key | Uses a tone suitable for a dark subject. |

Applying filter effects to monochrome pictures (Color Filter)

In the monochrome setting of picture mode (P. 78) settings, you can add and store a filter effect in advance. This creates a monochrome image in which the color matching the filter color is brightened and the complementary color is darkened.

- Press the button in **P/A/S/M** modes.
 - In **Auto**, **ART**, **SCN**, and **AP** modes, the display of the LV super control panel is controlled via [Control Settings] (P. 127).
- Use Δ ∇ \triangleleft \triangleright to select [Color Filter], then press the \odot button.
- Highlight an option using \triangleleft \triangleright and press the \odot button.

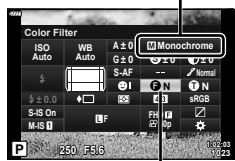





Picture Mode

Color Filter

| | |
|------------------|---|
| N:None | Creates a normal black and white image. |
| Ye:Yellow | Reproduces clearly defined white cloud with natural blue sky. |
| Or:Orange | Slightly emphasizes colors in blue skies and sunsets. |
| R:Red | Strongly emphasizes colors in blue skies and brightness of crimson foliage. |
| G:Green | Strongly emphasizes colors in red lips and green leaves. |

Adjusting the tone of a monochrome image (Monochrome Color)

In the monochrome setting of picture mode (P. 78) settings, you can add and store a color tint in advance.



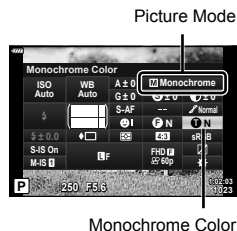

- 1 Press the  button in **P/A/S/M** modes.
 - In **Auto**, **ART**, **SCN**, and **AP** modes, the display of the LV super control panel is controlled via  Control Settings] (P. 127).
- 2 Use Δ ∇ \triangleleft \triangleright to select [Monochrome Color], then press the  button.
- 3 Use \triangleleft \triangleright to choose a value and press the  button.



| | |
|-----------------|---|
| N:Normal | Creates a normal black and white image. |
| S:Sepia | Creates a sepia image. |
| B:Blue | Creates a bluish image. |
| P:Purple | Creates a purplish image. |
| G:Green | Creates a greenish image. |

Adjusting i-Enhance effects (Effect)

You can set the i-Enhance effect strength in picture mode (P. 78).

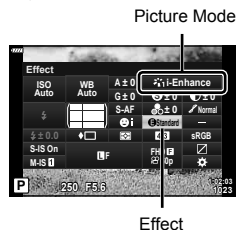

- 1 Press the  button in **P/A/S/M** modes.
 - In **Auto**, **ART**, **SCN**, and **AP** modes, the display of the LV super control panel is controlled via  Control Settings] (P. 127).
- 2 Use Δ ∇ \triangleleft \triangleright to select [Effect], then press the  button.
- 3 Adjust the effect using \triangleleft \triangleright and press the  button.



| | |
|--------------------------------------|--|
| Effect Low (Effect: Low) | Adds a low i-Enhance effect to images. |
| Effect STD (Effect: Standard) | Adds an i-Enhance effect between "low" and "high" to images. |
| Effect High (Effect: High) | Adds a high i-Enhance effect to images. |

Setting the color reproduction format (Color Space)

You can select a format to ensure that colors are correctly reproduced when shot images are regenerated on a monitor or using a printer. This option is equivalent to the [Color Space] (P. 129) in Custom Menu.

- 1 Press the  button in **P/A/S/M** modes.
 - In **Auto**, **ART**, **SCN**, and **AP** modes, the display of the LV super control panel is controlled via [Control Settings] (P. 127).
- 2 Use Δ ∇ \langle \rangle to select [Color Space], then press the  button.
- 3 Select a color format using \langle \rangle and press the  button.

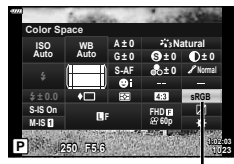

Color Space

| | |
|-----------------|---|
| sRGB | This is the RGB color space standard stipulated by the International Electrotechnical Commission (IEC). Normally, use [sRGB] as the standard setting. |
| AdobeRGB | This is a standard provided by Adobe Systems. Compatible software and hardware such as a display, printer etc. are required for a correct output of images. |

- [Adobe RGB] is not available in **ART** (P. 47) or movie mode (P. 60) or when Backlight HDR is selected in **SCN** mode (P. 35) or HDR is selected in **AP** mode (P. 41).

Changing the brightness of highlights and shadows (Highlight&Shadow Control)

Use [Highlight&Shadow Control] to adjust the brightness of highlights and shadows.

- Press the  button in **P/A/S/M** modes.
 - In **Auto**, **ART**, **SCN**, and **AP** modes, the display of the LV super control panel is controlled via [Control Settings] (P. 127).
- Use Δ ∇ \triangleleft \triangleright to select [Highlight&Shadow Control], then press the \odot button.
- Adjust brightness in shadows using the control dial or Δ ∇ \triangleleft \triangleright .
 - Settings can be reset by pressing and holding the \odot button.
- Press the **INFO** button to switch to mid-tones and then adjust brightness using the control dial or Δ ∇ \triangleleft \triangleright .
 - Settings can be reset by pressing and holding the \odot button.
- Press the **INFO** button to switch to highlights and then adjust brightness using the control dial or Δ ∇ \triangleleft \triangleright .
 - Settings can be reset by pressing and holding the \odot button.
 - Press the **INFO** button again to return to shadows (Step 3).
- Press the \odot button to save settings.

Notes

- You can also access these controls by pressing the  (Δ) button and then pressing the **INFO** button.

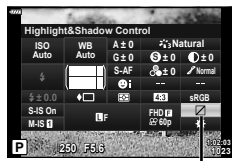

Highlight&Shadow Control



Assigning functions to buttons (Button Function)

At default settings, the following functions are assigned to the buttons:

| Button | Default |
|----------|--------------------------|
| Function | (Digital Tele-converter) |
| Function | REC |

To change the function assigned to a button, follow the steps below.



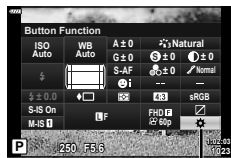















- Press the button in **P/A/S/M** modes.
 - In **Auto**, **ART**, **SCN**, and **AP** modes, the display of the LV super control panel is controlled via Control Settings] (P. 127).
- Use to select [Button Function], then press the button.
 - The custom menu [Button Function] item will be displayed.
 - [Button Function] can also be accessed from the menus (P. 113, 126).
- Use to highlight the desired button and press .
- Use to highlight the desired function and press the button.
- Press the button again to exit.



Button Function





Notes

- The functions assigned to the buttons may be unavailable in some modes.
- The options available vary with the current mode.

| | |
|---|--|
|  (AEL/AF Lock) | Press the button to use AE lock or AF lock. The function changes according to the [AEL/AF] (P. 131) setting. When AEL is selected, press the button once to lock the exposure and display  on the monitor. Press the button again to cancel the lock. |
|  REC | Press the button to record a movie. |
|  (Preview) | Aperture is stopped down to the selected value while the button is pressed. |
|  (One-touch white balance) | Press the shutter button while the button is pressed to acquire a white balance value (P. 81). Highlight the desired number and press the  button to save the value. |
|  (AF Area Select) | Press the button to choose the AF target (P. 70). |
| MF | Press the button to select [MF] mode. Press the button again to restore the previously selected AF mode. Hold the button and rotate the control dial to choose a focus mode. |
|  (Exposure compensation) | Press the button to adjust exposure compensation. In P , A , S , ART , movie, and some  modes, you can adjust exposure compensation (P. 69) by pressing the button and using  to choose the desired value. Some modes also offer program shift (P. 51). In M mode, you can adjust shutter speed or aperture by pressing the button and using    or the control dial to choose the desired values. • The role of the control dial can be changed in the  custom menus.  [Dial Function] (P. 126) |
|  (Digital Tele-converter) | Press the button to turn digital zoom [On] or [Off] (P. 115). |
|  (Magnify) | Press the button to display the magnification frame and press it again to magnify the image. Press and hold the button to cancel magnified display. |
| Peaking | Press the button to turn on and off the peaking display. When peaking is displayed, histogram and highlight/shadow display are not available (P. 132). |
|  (Switch  Lock) | Press and hold the button to enable and disable touch screen operation. |

■ Locking the exposure (AE Lock)

You can lock the exposure by pressing the button to which  has been assigned (P. 97). Use this when you want to adjust the focus and exposure separately or when you want to shoot several images at the same exposure.

- If you press the button to which  has been assigned once, the exposure is locked and  is displayed.  "AEL/AF" (P. 131)
- Press the button to which  has been assigned once again to release the AE Lock.
- The lock will be released if you operate the mode dial, **MENU** button, or  button.

■ Zoom frame AF/Zoom AF (Super Spot AF)

You can zoom in on a portion of the frame when adjusting focus. Choosing a high zoom ratio allows you to use autofocus to focus on a smaller area than is normally covered by the AF target. You can also position the focus target more precisely. Press and hold the button to which [Q] has been assigned to cycle through the displays as follows:

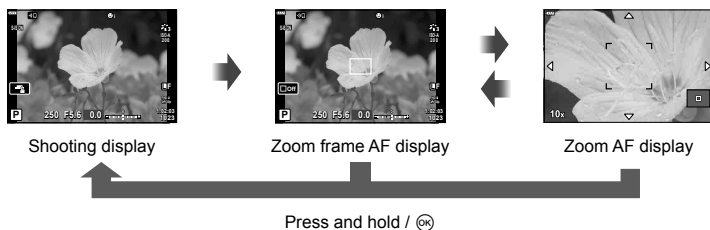

- 1 Assign [Q] to the **Fn** or button.
 - To use Super Spot AF, you must first assign [Q] to the **Fn** or button (P. 97).
 - 2 Press the button to which [Q] has been assigned to display the zoom frame.
 - If the subject has been focused using autofocus immediately before the button is pressed, the zoom frame will be displayed at the current focus position.
 - Use to position the zoom frame.
 - Press the **INFO** button and use to choose the zoom ratio. (×3, ×5, ×7, ×10, ×14)
 - 3 Press the assigned button again to zoom in on the zoom frame.
 - Use to position the zoom frame.
 - You can change the zoom ratio by rotating the control dial.
 - 4 Press the shutter button halfway to initiate autofocus.
 - The camera will focus using the subject in the frame at the center of the screen. Use to choose a different focus position.
- Zoom is visible only in the monitor and has no effect on the resulting photographs.
 - Press and hold the assigned button or press the button to end zoom and exit the zoom frame AF display.
 - When you are using a Four Thirds system lens, the AF will not operate with during zoom display.
 - While zoomed in, a sound is made by the IS (Image Stabilizer).

Notes

- Touch controls can also be used.

3 Playback

Information display during playback

Playback image information

Simplified display

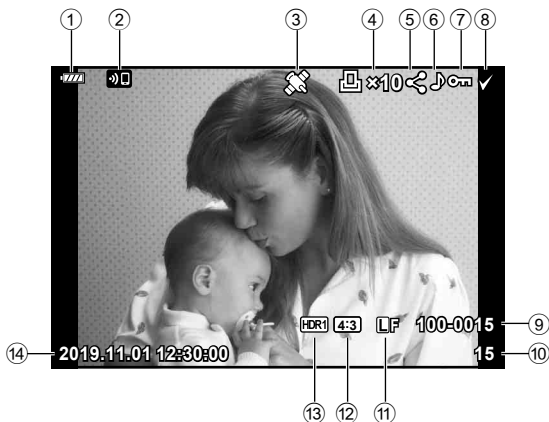

Overall display

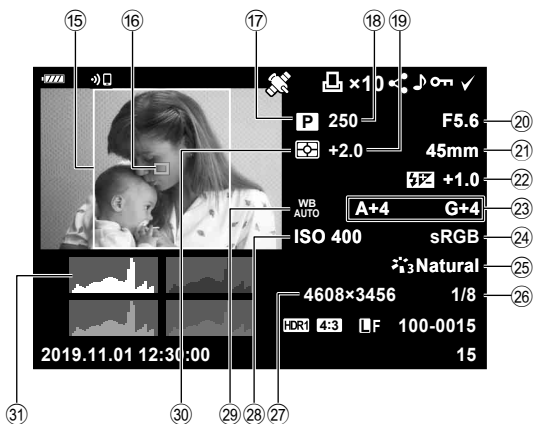

- | | |
|---|--|
| ① Battery level.....P. 20 | ⑰ Shooting mode.....P. 27–59 |
| ② Wireless LAN connection.....P. 136–143 | ⑱ Shutter speedP. 51–54 |
| ③ Including GPS informationP. 141 | ⑲ Exposure compensationP. 69 |
| ④ Print order Number of printsP. 107 | ⑳ Aperture valueP. 51–54 |
| ⑤ Share order.....P. 106 | ㉑ Focal length |
| ⑥ Sound recordP. 108, 121 | ㉒ Flash intensity control.....P. 88 |
| ⑦ ProtectP. 105 | ㉓ White balance compensation.....P. 90 |
| ⑧ Image selectedP. 106 | ㉔ Color space.....P. 95 |
| ⑨ File number.....P. 130 | ㉕ Picture mode.....P. 78, 115 |
| ⑩ Frame number | ㉖ Compression rateP. 135 |
| ⑪ Image qualityP. 83 | ㉗ Pixel countP. 135 |
| ⑫ Aspect ratio.....P. 83 | ㉘ ISO sensitivity.....P. 79 |
| ⑬ HDR imageP. 41 | ㉙ White balanceP. 80 |
| ⑭ Date and timeP. 21 | ㉚ Metering mode.....P. 91 |
| ⑮ Aspect borderP. 83 | ㉛ HistogramP. 26 |
| ⑯ AF area pointer.....P. 70 | |

Switching the information display

You can switch the information displayed during playback by pressing the **INFO** button.

INFO button

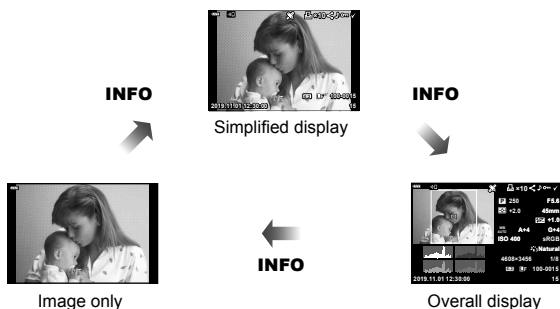
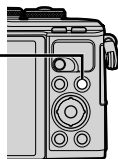









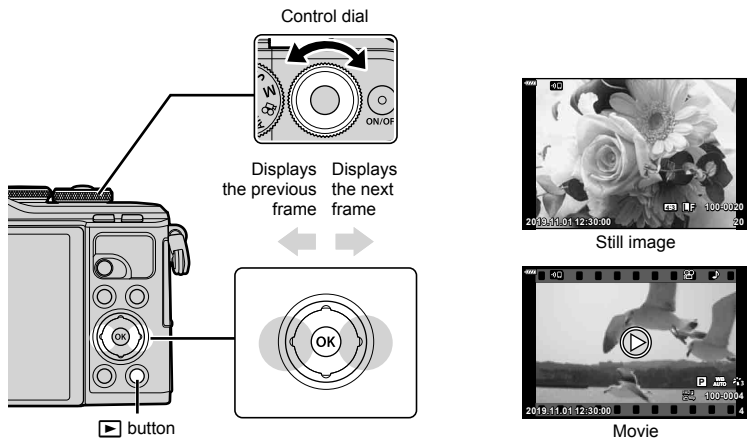















- You can add histogram and highlight & shadow to the information displayed during playback. [Info] (P. 132)

Viewing photographs and movies

1 Press the button.

- A photograph or movie will be displayed.
- Select the desired photograph or movie using the control dial or arrow pad.
- To return to shooting mode, press the shutter button halfway or press the  button.



| | |
|--|---|
| Control dial | Single-frame playback: Previous () / Next () Close-up playback: You can display the next frame or the previous frame during close-up playback. Index/My Clips/calendar playback: Highlight image |
| Arrow pad (   ) | Single-frame playback: display the next frame () / display the previous frame () / jump ahead 10 frames () / jump back 10 frames () Close-up playback: Changing the close-up position You can display the next frame () or the previous frame () during close-up playback by pressing the INFO button. Press the INFO button again to display a zoom frame and use     to change its position. Index/My Clips/calendar playback: Highlight image |
|  () button | Index display |
| Fn () button | Close-up playback |
|  () button | Select images for sharing (P. 106) |
| INFO button | View image info |
|  button | Delete picture (P. 105) |
|  button | View menus (in calendar playback, press this button to exit to single-frame playback) |

Index display/Calendar display

- From single-frame playback, press the  button for index playback. Press the  button further for My Clips playback and further still for calendar playback.
- Press the  button to return to single-frame playback.

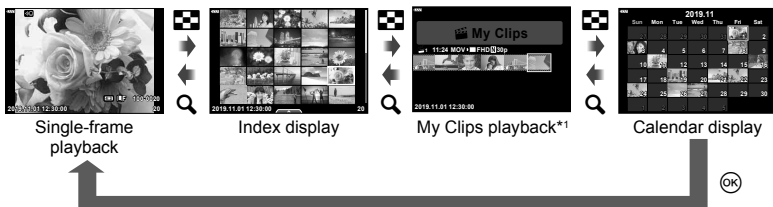

*1 If one or more My Clips have been created, it will be displayed here (P. 63).



- You can change the number of frames for index display.  [Settings] (P. 133)

Notes

- Touch controls can also be used (P. 112).

Viewing still images

Close-up playback

In single-frame playback, press the  button to zoom in. Press the  button to return to single-frame playback.

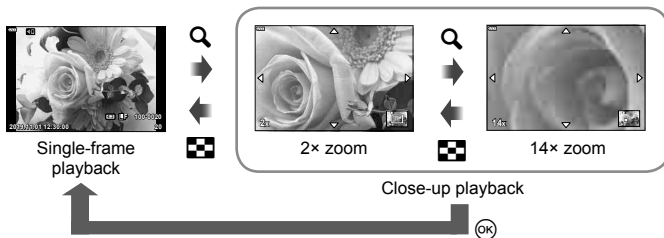





Notes

- Touch controls can also be used (P. 111).

Rotate

Choose whether to rotate photographs.

- 1 Play the photograph back and press the  button.
- 2 Select [Rotate] and press the  button.
- 3 Press  to rotate the image counterclockwise,  to rotate it clockwise; the image rotates each time the button is pressed.
 - Press the  button to save settings and exit.
 - The rotated image is saved in its current orientation.
 - Movies and protected images cannot be rotated.

Slideshow

This function displays images stored on the card one after another.

- 1 Press the **OK** button in the playback display.
- 2 Select [**⏏**] and press the **OK** button.



- 3 Adjust settings.

| | |
|-----------------------|---|
| Start | Start the slideshow. Images are displayed in order, starting with the current picture. |
| BGM | Set [Happy Days] or [Off]. |
| Slide | Set the type of data to be played back. |
| Slide Interval | Choose the length of time each slide is displayed from 2 to 10 seconds. |
| Movie Interval | Select [Full] to play back full length of each movie clip in the slideshow or [Short] to play back only the opening portion of each movie clip. |

- 4 Select [Start] and press the **OK** button.
 - The slideshow will start.
 - Press Δ ∇ during the slideshow to adjust the overall volume of the camera speaker. Press \triangleleft \triangleright while the volume adjustment indicator is displayed to adjust the balance between the sound recorded with the image or movie and background music.
 - Press the **OK** button to stop the slideshow.

BGM other than [Happy Days]

To use BGM other than [Happy Days], record data that you have downloaded from the Olympus website onto the card and select it as [BGM] in Step 3. Visit the following website for the download.

<http://support.olympus-imaging.com/bgmdownload/>

Watching movies

Select a movie and press the **OK** button to display the playback menu. Select [Play Movie] and press the **OK** button to begin playback. Fast-forward and rewind using **</>**. Press the **OK** button again to pause playback. While playback is paused, use **Δ** to view the first frame and **∇** to view the last frame. Use **</>** or the control dial to view previous or next frame. Press the **MENU** button to end playback.

- Use **Δ** **∇** to adjust the volume during movie playback.



Notes

- Touch controls can also be used (P. 111).

For movies of 4 GB or larger

If the movie was automatically split into multiple files, pressing **OK** will display a menu containing the following options:

| | |
|------------------------|--|
| [Play from Beginning]: | Plays back a split movie all the way through |
| [Play Movie]: | Plays back files separately |
| [Delete entire]: | Deletes all parts of a split movie |
| [Erase]: | Deletes files separately |

- We recommend using the latest version of Olympus Workspace to play back movies on a computer. Before launching the software for the first time, connect the camera to the computer.



Protecting images

Protect images from accidental deletion. Display an image you wish to protect and press **OK** to display the playback menu. Select [**Protect**] and press **OK**, and then press **Δ** or **∇** to protect the image. Protected images are shown by a **Protect** (protect) icon. Press **Δ** or **∇** to remove protection. You can also protect multiple selected images.

“Selecting images (**Protect**, Erase Selected, Share Order Selected)” (P. 106)

- Formatting the card erases all data including protected images.

Protect (protect) icon



Erasing an image

Display an image you want to delete and press the **Trash** button. Select [Yes] and press the **OK** button.

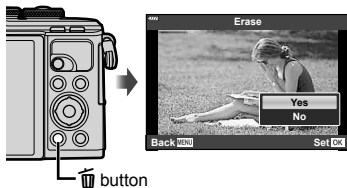

Setting a transfer order on images (Share Order)

You can select images you want to transfer to a smartphone in advance. You can also use **Ol.Share** to browse the images included in the share order. When playing back images you want to transfer, press the **OK** button to display the playback menu. After selecting **[Share Order]** and pressing the **OK** button, press **Δ** or **∇** to set a share order on an image and display **◀**. To cancel a share order, press **Δ** or **∇**.

You can select images you want to transfer in advance and set a share order all at once.

- You can set a share order on 200 frames.
- Share orders cannot include RAW images.

Notes

Pictures can also be marked for sharing using the **◀** (⊙) button. If the **◀** (⊙) button is currently assigned a role other than **[◀]**, assign it the **[◀]** role using the **[▶]⊙** [Function] option in the custom menus (P. 126).



Canceling a share order

Cancel share orders that are set on images.

- 1 Highlight **[Reset share Order]** in the **[▶]** playback menu and press the **OK** button.
- 2 Select **[Yes]** and press the **OK** button.

Selecting images (On, Erase Selected, Share Order Selected)

You can select multiple images for **[On]**, **[Erase Selected]** or **[Share Order Selected]**.

- To select multiple images, you will first need to select **[✓]** for **[▶]⊙** [Function] (P. 126).

Press the **◀** (⊙) button on the index display screen (P. 103) to select an image; a **✓** icon will appear on the image. Press the **◀** (⊙) button again to cancel the selection.

Press the **OK** button to display the menu, and then select from **[On]**, **[Erase Selected]** or **[Share Order Selected]**. This function is also available in single-frame playback.



Notes

- Touch controls can also be used (P. 112).

Creating a print order (DPOF)

You can select pictures for printing and choose the number of copies and the information printed on each picture. The pictures can be printed at print shops that support the Digital Print Order Format (DPOF). A digital print order is stored on the memory card.

- 1 Press the **OK** button in the playback display.
- 2 Select [**Print Order**] and press the **OK** button.



- 3 Select [**Print Order**] or [**Print Order ALL**] and press the **OK** button.

Individual picture

Press **<>** to select the frame that you want to set as print reservation, then press **△**/**▽** to set the number of prints.

- To set print reservation for several pictures, repeat this step. Press the **OK** button when all the desired pictures have been selected.

All pictures

Select [**Print Order ALL**] and press the **OK** button.

- 4 Select the date and time format and press the **OK** button.

| | |
|-------------|---|
| No | The pictures are printed without the date and time. |
| Date | The pictures are printed with the shooting date. |
| Time | The pictures are printed with the shooting time. |

- When printing images, the setting cannot be changed between the images.

- 5 Select [**Set**] and press the **OK** button.

- The camera cannot be used to modify print orders created with other devices. Creating a new print order deletes any existing print orders created with other devices.
- Print orders cannot include RAW images or movies.

Removing all or selected pictures from the print order

You can reset all print reservation data or just the data for selected pictures.

- 1 Press the **OK** button in the playback display.
- 2 Select [**Print Order**] and press the **OK** button.
- 3 Select [**Print Order**] and press the **OK** button.
 - To remove all pictures from the print order, select [Reset] and press the **OK** button. To exit without removing all pictures, select [Keep] and press the **OK** button.
- 4 Press **◀▶** to select images you wish to remove from the print order.
 - Use **▽** to set the number of prints to 0. Press the **OK** button once you have removed all the desired pictures from the print order.
- 5 Select the date and time format and press the **OK** button.
 - This setting is applied to all frames with print reservation data.
- 6 Select [Set] and press the **OK** button.

Audio recording

Audio can be added to still images (up to 30 sec. long).

- 1 Display the image to which you want to add audio and press the **OK** button.
 - Audio recording is not available with protected images.
 - Audio recording is also available in the playback menu.
- 2 Select [**Audio**] and press the **OK** button.
 - To exit without adding audio, select [No].
- 3 Select [**Start**] and press the **OK** button to begin recording.
- 4 Press the **OK** button to end recording.
 - Images recorded with audio are indicated by a **♪** icon.

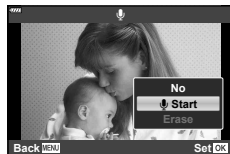
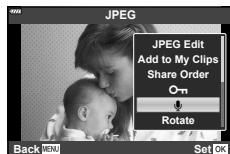

- To delete recorded audio, select [Erase] in Step 3.

Audio Playback





If an audio recording is available for the current picture, pressing the **OK** button will display audio playback options. Highlight [Play **♪**] and press the **OK** button to begin playback. To end playback, press the **OK** or **MENU** button. During playback, you can press **△▽** to raise or lower the volume.

Notes

- Audio recordings can also be played back using touch controls (P. 111).

Viewing My Clips



You can play back the files in My Clips consecutively.

- 1 Press the  button and select an image marked .
- 2 After pressing the  button to display the menus, highlight [Play My Clips] using Δ ∇ and press the  button.
 - The files in My Clips will play back consecutively.
 - Press the  button to end the consecutive playback.









Adding still pictures to My Clips

You can also select still pictures and add them to My Clips.

Display the still picture you wish to add and press the  button to display the menu. Select [Add to My Clips] and press the  button. Using Δ ∇ \triangleleft \triangleright , select My Clips and the order in which you wish to add the pictures, then press the  button.

- RAW pictures are added to My Clips as low-resolution preview images.

Removing clips from My Clips

- 1 Press the  button and display a picture marked with a .
- 2 Press the  button to view options, then highlight [See all My Clips] using Δ ∇ and press the  button.
 - A list of clips will be displayed.
- 3 Highlight a clip you wish to remove using Δ ∇ \triangleleft \triangleright .
- 4 Press the  button to view options, then highlight [Remove from My Clips] using Δ ∇ and press the  button.
 - The highlighted clip will be removed from My Clips.
 - Clips removed from My Clips are treated as normal movies.
 - The same procedure can be used to remove photos from My Clips.

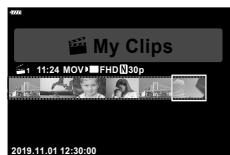

Tips

- Clips that have been removed can be added to My Clips again as described in "Adding still pictures to My Clips".

Scrolling Panoramas

Panoramas made up of multiple images joined together can be viewed in a scrolling display.

- 1 Select a panorama in single-frame playback.
- 2 Press the **Fn** (Q) button.
 - Use \triangle ∇ \triangleleft \triangleright to scroll.



- During playback, you can press the **Fn** (Q) button to zoom in from 2× to 14× or press the \blacktriangleright (Z) button to zoom out. Press the (OK) button to return to single-frame playback.
- To view other images at zoom ratios above 2×, press the **INFO** button and then press \triangleleft \triangleright . Press the **INFO** button again to re-enable scrolling. You can also view other images using the control dial.

Notes

- Touch controls can also be used (P. 111).

Using the touch screen

You can use the touch screen to manipulate images.

- Do not tap the display with your fingernails or other sharp objects.
- Gloves or monitor covers may interfere with touch screen operation.

Single-frame playback

■ Displaying the previous or next image

- Slide your finger to the left to view the next image, and right to view the previous image.

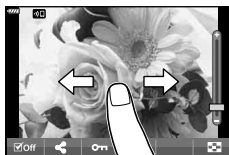



■ Magnify

- Lightly tap the screen to display the slider and .
- Slide the bar up or down to zoom in or out.
- Slide your finger to scroll the display area when the picture is zoomed in.





■ Audio playback/Movie playback





- Tap  to start playback.
- To adjust volume during playback, place a finger on the display and slide it up or down.
- Movie playback can be paused by tapping the display. Tap again to resume playback.
- While playback is paused, you can slide the playback position indicator at the bottom of the screen left or right to choose a new starting point.
- Tap  to end playback.



Index/My Clips/Calendar playback

Lightly tapping the display during single-frame playback displays a  icon. Tap  to display index playback. Tap  for calendar playback and My Clips playback.

■ Displaying the previous or next page

- Slide your finger up to view the next page, and down to view the previous page.
- Tap  or  to switch the number of images displayed.   [Settings] (P. 127)
- Tap  several times to return to single-frame playback.

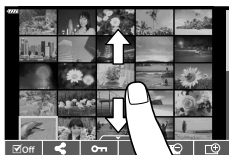





■ Viewing images

- Tap an image to view it full frame.

Selecting and protecting images

To view the touch menu, lightly tap the display (single-frame playback) or tap the  icon (index playback). You can then perform the desired operation by tapping the icons in the touch menu.



| | |
|---|--|
|  | Select an image. You can select multiple images and delete them collectively. |
|  | Images you want to share with a smartphone can be set.  "Setting a transfer order on images (Share Order)" (P. 106) |
|  | Protects an image. |

Viewing pictures in self-portrait mode

■ Displaying the previous or next image

The controls are the same as for single-frame playback (P. 111).

■ Magnify

The controls are the same as for single-frame playback (P. 111).

■ Audio playback/Movie playback

The controls are the same as for single-frame playback (P. 111).

■ Selecting pictures for sharing

- Tap the monitor to display the share icon.
- Tap  to select pictures for sharing.



■ Returning to shooting mode

- Tap  to return to shooting mode (P. 67).



Notes

- The **INFO** button is disabled in self-portrait mode.

4 Menu functions

Basic menu operations

The menus can be used to customize the camera for ease of use and include shooting and playback options not accessible via the live control, LV super control panel, or the like.

| | |
|--|---|
| | Shooting setup and shooting settings (P. 114) |
| | Movie mode settings (P. 119) |
| | Playback and retouch options (P. 120) |
| | Customizing camera settings (P. 126) |
| | Camera setup (e.g., date and language) (P. 124) |

4

Menu functions (Basic operations)

Functions that cannot be selected from menus

Some items may not be selectable from the menus when using the arrow pad.

- Items that cannot be set with the current shooting mode.
- Items that cannot be set because of an item that has already been set:
Settings such as picture mode are unavailable when the mode dial is rotated to .

1 Press the **MENU** button to display the menus.

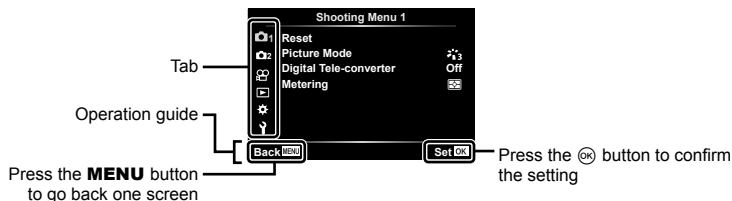

- A guide is displayed in 2 seconds after you select an option.
- Press the **INFO** button to view or hide guides.

2 Use Δ / ∇ to select a tab and press the **OK** button.

- The menu group tab appears when the Custom Menu is selected. Use Δ / ∇ to select the menu group and press the **OK** button.

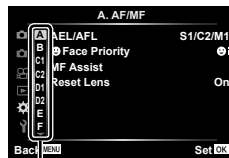

- 3 Select an item using Δ ∇ and press the \odot button to display options for the selected item.

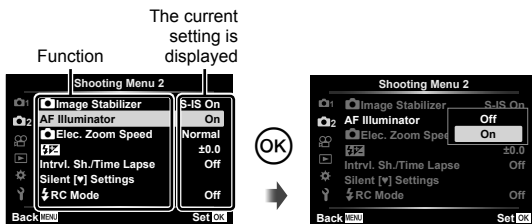

- 4 Use Δ ∇ to highlight an option and press the \odot button to select.
 - Press the **MENU** button repeatedly to exit the menu.

Notes

- For the default settings of each option, refer to “Defaults” (P. 162).

Using Shooting Menu 1/Shooting Menu 2



Shooting Menu 1

- Reset
- Picture Mode (P. 78, 115)
- Digital Tele-converter (P. 115)
- Metering (P. 91)

Shooting Menu 2

- Image Stabilizer (P. 89)
- AF Illuminator (P. 115)
- Elec. Zoom Speed (P. 116)
- (P. 88)
- Intrvl. Sh./Time Lapse (P. 116)
- Silent [♥] Settings (P. 117)
- RC Mode (P. 118)



Returning to default settings (Reset)

Camera settings can be easily restored to default settings.





- 1 Select [Reset] in Shooting Menu 1 and press the \odot button.
- 2 Highlight a reset option ([Full] or [Basic]) and press the \odot button.
 - To reset all settings except the time, date, and a few others, highlight [Full] and press the \odot button. “Defaults” (P. 162)
- 3 Select [Yes] and press the \odot button.

Processing options (Picture Mode)

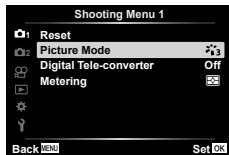
You can make individual adjustments to contrast, sharpness and other parameters in [Picture Mode] (P. 78) settings. Changes to parameters are stored for each picture mode separately.



- 1 Select [Picture Mode] in  Shooting Menu 1 and press the  button.
 - The camera will display the picture mode available in the current shooting mode.



- 2 Select an option with   and press the  button.
 - Press  to set the detailed options for the selected picture mode. Detailed options are not available for some picture modes.
 - Changes to contrast have no effect at settings other than [Normal].

Digital Zoom (Digital Tele-converter)

Digital Tele-converter is used to zoom in beyond the current zoom ratio. The camera saves the center crop. The subject is nearly doubled in size.

- 1 Select [On] for [Digital Tele-converter] in  Shooting Menu 1.
- 2 The view in the monitor will be enlarged by a factor of two.
 - The subject will be recorded as it appears in the monitor.
 - Digital zoom is not available when [Panorama] is selected in **SCN** mode, multiple exposure, panorama, or keystone compensation is selected in  mode or when [Standard] is selected in movie mode.
 - When a RAW image taken with [On] selected for [Digital Tele-converter] is displayed, the area visible in the monitor is indicated by a frame.
 - AF target drops.
 -  is displayed on the monitor.

Improving Focus in Dark Surroundings (AF Illuminator)

The AF illuminator (AF assist lamp) lights to assist the focus operation in dark environments. Select [Off] to disable AF illuminator.

To use the AF illuminator during silent photography, you will need to change the option selected for [Silent  Settings] (P. 117).

Choosing a Zoom Speed (📷 Elec. Zoom Speed)

Choose the speed at which electronic zoom lenses can be zoomed in or out using the zoom ring during still photography.

- 1 Highlight [📷 Elec. Zoom Speed] in **2** Shooting Menu 2 and press the **OK** button.
- 2 Select an option with Δ ∇ and press the **OK** button.

Shooting automatically with a fixed interval (Intrvl. Sh./Time Lapse)

You can set the camera to shoot automatically with a set time lapse. The shot frames can also be recorded as into a single movie. This setting is only available in **P/A/S/M** modes.

- 1 Highlight [Intrvl. Sh./Time Lapse] in **2** Shooting Menu 2 and press the **OK** button.



- 2 Select [On] and press the **▶**.
- 3 Adjust the following settings and press the **OK** button.

| | |
|---------------------------|--|
| Number of Frames | Sets the number of frames to be shot. |
| Start Waiting Time | Sets waiting time before starting to shoot. |
| Interval Length | Sets interval between shots after shooting starts. |
| Time Lapse Movie | Sets recording format of frame sequence. [Off]: Records each frame as a still picture. [On]: Records each frame as a still picture and generates a single movie from the frame sequence. |
| Movie Settings | [Movie Resolution]: Choose a size for time lapse movies. [Frame Rate]: Choose a frame rate for time lapse movies. |



- The starting and ending times shown in the display are intended as a guide only. The actual times may vary with shooting conditions.
- 4 The [Off]/[On] options will be displayed once more; confirm that [On] is highlighted and press the **OK** button again.
 - 5 Shoot.

- Frames are shot even if the image is not in focus after AF. If you wish to fix the focus position, shoot in MF.
- [Rec View] (P. 124) operates for 0.5 seconds.
- If either of the time before shooting, or shooting interval is set to 1 minute 31 seconds or longer, the monitor and camera power will turn off after 1 minute. 10 seconds before shooting, the power will automatically turn on again. When the monitor is off, press the **ON/OFF** button to turn it on again.
- If the AF mode (P. 81) is set to [C-AF] or [C-AF+TR], it is automatically changed to [S-AF].
- Touch operations are disabled during time lapse shooting.
- Bulb, time, and composite photography are not available during time lapse photography.
- The flash will not work if the flash charging time is longer than the interval between shots.
- If any of still pictures are not recorded correctly, the time lapse movie will not be generated.
- If there is insufficient space on the card, the time lapse movie will not be recorded.
- The following cancel time-lapse shooting:
using the mode dial, **MENU** button,  button, or lens-release button; connecting a USB cable; turning the camera off
- If there is not enough charge left on the battery, the shooting may end partway through. Make sure the battery is charged enough before shooting.
- Movies recorded with [4K] selected for [Movie Settings] > [Movie Resolution] may not display on some computer systems. More information is available on the OLYMPUS website.



Silent-Mode Options (Silent [♥] Settings)

Choose the following options when shooting in the silent mode (P. 75):





- Noise reduction on/off
- Whether or not to enable , [AF Illuminator], and [Flash Mode]

- 1 Highlight [Silent [♥] Settings] in  Shooting Menu 2 and press the  button.



- 2 Select an option with   and press .

3 Adjust the following settings and press the button.

| | |
|---|---|
| Noise Reduction  | [Auto]: Reduce noise in long exposures when shooting in the silent mode (P. 75). The sound of the shutter may be audible when noise reduction is active. [Off]: Noise reduction off. |
| ■))) (Beep sound) | [Allow]: Uses the settings currently selected for ■))) in  Custom Menu  (P. 127). [Not Allow]: Turns off the beep sound when shooting in the silent mode. |
| AF Illuminator | [Allow]: Uses the settings currently selected for [AF Illuminator] in  Shooting Menu 2 (P. 115). [Not Allow]: Disables the AF Illuminator when shooting in the silent mode. |
| Flash Mode | [Allow]: Uses the current flash settings (P. 72). [Not Allow]: Disables the flash when shooting in the silent mode. |

Wireless remote control flash photography (RC Mode)

You can take wireless flash photographs using the built-in flash and a special flash with a remote control function.  "Wireless remote control flash photography" (P. 150)

Using the Video Menu

Movie recording functions are set in the Video Menu.



| Option | Description | |
|-------------------------|---|----|
| Movie | [Off]: Record movies without sound. [On]: Record movies with sound. [On]: Record movies with sound; wind noise reduction enabled. | 58 |
| Recording Volume | Adjust the sensitivity of the built-in microphone. Adjust the sensitivity using Δ ∇ while checking the peak sound level picked up by the microphone over the previous few seconds. | — |
| AF Mode | Choose the AF mode for movie recording. | 81 |
| Image Stabilizer | Sets image stabilization for movie recording. | 89 |
| Elec. Zoom Speed | Choose the speed at which electronic zoom lenses can be zoomed in or out during movie recording. | — |
| Video Frame Rate | Choose the frame rate for movie recording. • When shooting movies that will be viewed on a television, choose a frame rate that matches the video standard used in the device, as otherwise the movie may not play back smoothly. Video standards vary by country or region: some use NTSC, others PAL. - When shooting for display on NTSC devices, choose 60p (30p) - When shooting for display on PAL devices, choose 50p (25p) | 84 |
| Video Bit Rate | Choose the compression ratio for movie recording. | 84 |

- Operation sounds of the lens and camera may be recorded in a movie. To prevent it from recording, reduce the operation sounds by setting [AF Mode] to [S-AF] or [MF], or by minimizing the button operations of the camera.
- Sound cannot be recorded in ^{ART} (Diorama) mode.
- When [Movie] is set to [Off], is displayed.

Using the Playback Menu

Playback Menu

 (P. 104)



Edit

Print Order (P. 107)

Reset Protect (P. 123)

Reset share Order (P. 106)

Device Connection (P. 137)











4

Displaying images rotated ()



If set to [On], images in portrait orientation are automatically rotated to be displayed in the correct orientation on the playback display.





Editing still images (Edit)

Recorded images can be edited and saved as separate images.

- 1 Select [Edit] in the  Playback Menu and press the  button.
- 2 Use   to select [Sel. Image] and press the  button.
- 3 Use   to select the image to be edited and press the  button.
 - [RAW Data Edit] is displayed if a RAW image is selected, and [JPEG Edit] if a JPEG image is selected. For images recorded in RAW+JPEG format, both [RAW Data Edit] and [JPEG Edit] are displayed. Select the desired option from them.
- 4 Select [RAW Data Edit] or [JPEG Edit] and press the  button.

| | | |
|---------------|--|--|
| RAW Data Edit | Creates a JPEG copy of a RAW image according to the selected settings. | |
| | Current | The JPEG copy is processed using the current camera settings. Adjust the camera settings before choosing this option. Some settings such as exposure compensation are not applied. |
| | ART BKT | The image is edited using settings for the selected art filter. |

| | |
|------------------|--|
| JPEG Edit | <p>Choose from the following options: [Shadow Adj]: Brightens a dark backlit subject. [Redeye Fix]: Reduces the red-eye phenomenon due to flash shooting.</p> <p>[]: Trims an image. Use the control dial to choose the size of the crop and $\Delta \nabla \triangleleft \triangleright$ to specify the crop position.</p>  |
| | <p>[Aspect]: Changes the aspect ratio of images from 4:3 (standard) to [3:2], [16:9], [1:1], or [3:4]. After changing the aspect ratio, use $\Delta \nabla \triangleleft \triangleright$ to specify the trimming position. [Black & White]: Creates black and white images. [Sepia]: Creates sepia-toned images. [Saturation]: Increases the vividness of images. Adjust the color saturation checking the image on the screen. []: Converts the image size to 1280 × 960, 640 × 480, or 320 × 240. Images with an aspect ratio other than 4:3 (standard) are converted to the closest image size. [e-Portrait]: Compensates the skin look for smoothness. Compensation cannot be applied in such a case that a face cannot be detected.</p> |

- 5** When the settings are complete, press the  button.
 - The settings are applied to the image.
 - 6** Select [Yes] and press the  button.
 - The edited image is stored in the card.
- Red-eye correction may not work depending on the image.
 - Editing of a JPEG image is not possible in the following cases:
 - When an image is processed on a PC, when there is not enough space in the card memory, or when an image is recorded on another camera.
 - The image cannot be resized () to the larger size than the original size.
 - Some images can not be resized.
 - [] (trimming) and [Aspect] can only be used to edit images with an aspect ratio of 4:3 (standard).

Audio recording

Audio can be added to still images (up to 30sec. long).
 This is the same function as [] during playback (P. 108).

Image overlay

Up to 3 frames of RAW images taken with the camera can be overlaid and saved as a separate image.

The image is saved with the record mode set at the time the image is saved. (If [RAW] is selected, the copy will be saved in RAW+JPEG format.)

- 1 Select [Edit] in the Playback Menu and press the button.
- 2 Use $\Delta \nabla$ to select [Image Overlay] and press the button.
- 3 Select the number of images to be overlaid and press the button.
- 4 Use $\Delta \nabla \triangleleft \triangleright$ to select the RAW images and press the button to add them to the overlay.
 - The overlaid image will be displayed if images of the number specified in step 3 are selected.
- 5 Adjust the gain for each image to be overlaid.
 - Use $\triangleleft \triangleright$ to select an image and $\Delta \nabla$ to adjust gain.
 - Gain can be adjusted in the range 0.1–2.0. Check the results in the monitor.
- 6 Press the button to display the confirmation dialog. Select [Yes] and press the button.

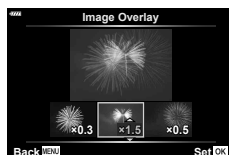
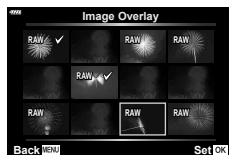

Notes











- To overlay 4 or more frames, save the overlay image as a RAW file and use [Image Overlay] repeatedly.

Saving a still image from a movie (In-Movie Image Capture)

Save selected frames from 4K movies as still images.



- 1 Select [Edit] in the Playback Menu and press the button.
 - 2 Use $\Delta \nabla$ to select [Sel. Image] and press the button.
 - 3 Use $\triangleleft \triangleright$ to select a movie and press the button.
 - 4 Select [Movie Edit] and press the button.
 - 5 Use $\Delta \nabla$ to select [In-Movie Image Capture] and press the button.
 - 6 Use $\triangleleft \triangleright$ to select a frame to be saved as a still image and press the button.
 - Use $\Delta \nabla$ or to skip multiple frames.
 - Press the **MENU** button to return to single-frame playback.
- Editing is available with movies recorded using this camera.
 - The date of recording of the still may differ from that of the original movie.

Trimming movies (Movie Trimming)

- 1 Select [Edit] in the  Playback Menu and press the  button.
- 2 Use $\Delta \nabla$ to select [Sel. Image] and press the  button.
- 3 Use $\triangleleft \triangleright$ to select a movie and press the  button.
- 4 Select [Movie Edit] and press the  button.
- 5 Use $\Delta \nabla$ to select [Movie Trimming] and press the  button.
- 6 Select [Overwrite] or [New File] and press the  button.
 - If the image is protected, you cannot select [Overwrite].
- 7 Choose whether the section to be deleted begins with the first frame or ends with the last frame, using $\triangleleft \triangleright$ to highlight the desired option and pressing the  button to select.
- 8 Use $\triangleleft \triangleright$ to choose the section to be deleted.
 - The section to be deleted is shown in red.
- 9 Press the  button.
- 10 Select [Yes] and press the  button.
 - Editing is available with movies recorded using this camera.
 - The date of recording of the still may differ from that of the original movie.

Canceling all protections

Protections of multiple images can be canceled at a time.

- 1 Select [Reset Protect] in the  Playback Menu and press the  button.
- 2 Select [Yes] and press the  button.

Using the setup menu

Use the **Y** Setup Menu to set the basic camera functions.

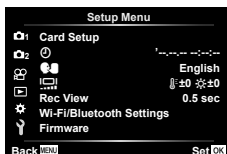





| Option | Description | |
|---|---|---------------------|
| Card Setup | Format the card and delete all images. | 125 |
| ⌚ (Date/time setting) | Set the camera clock. | 21 |
| 🗣️ (Changing the display language) | Choose a different language for the menus and messages displayed in the monitor. | 125 |
| 📺 (Monitor brightness adjustment) | <p>You can adjust the brightness and color temperature of the monitor. Use <D> to highlight ☺ (color temperature) or ☼ (brightness) and Δ ▽ to adjust the value.</p>  <p>Press the INFO button to switch the saturation of the monitor between [Natural] and [Vivid] settings.</p> | — |
| Rec View | <p>Sets whether to display the captured image on the monitor after shooting, and the length of time for the display. This is useful for a brief check of the picture you have taken. You can shoot the next shot by pressing the shutter button halfway while the captured image is displayed on the monitor.</p> <p>[0.3sec]–[20sec]: Sets the length of time (seconds) to display the captured image on the monitor.</p> <p>[Off]: The captured image is not displayed on the monitor.</p> <p>[Auto ▶]: Displays the captured image, and then switches to playback mode. This is useful for erasing a picture after checking it.</p> | — |
| Wi-Fi/Bluetooth Settings | Adjust settings for connection to Wi-Fi/ Bluetooth -compatible smartphones using the camera's wireless function. | 138, 142, 143 |
| Firmware | <p>Displays the firmware versions of the camera and connected accessories.</p> <p>Check the versions when you inquire about the camera or accessories or when you download the software.</p> | — |

Formatting the card (Card Setup)

Cards must be formatted with this camera before first use or after being used with other cameras or computers.

All data stored on the card, including protected images, is erased when the card is formatted.



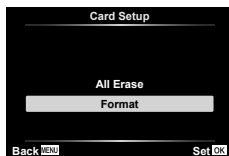

When formatting a used card, confirm there are no images that you still want to keep on the card.  “Usable cards” (P. 147)

- 1 Select [Card Setup] in the  Setup Menu and press the  button.
 - If there is data on the card, menu items appear. Select [Format] and press the  button.
- 2 Select [Yes] and press the  button.
 - Formatting is performed.



Deleting all images (Card Setup)





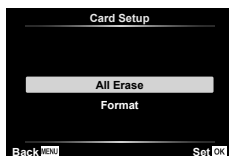







All images on a card can be deleted at a time. Protected images are not deleted.

- 1 Select [Card Setup] in the  Setup Menu and press the  button.
- 2 Select [All Erase] and press the  button.
- 3 Select [Yes] and press the  button.
 - All images are deleted.



Choosing a language ()

Choose a different language for the menus and messages displayed in the monitor.



- 1 Select [] in the  Setup Menu and press the  button.
- 2 Highlight the desired language using     or the control dial.
 - The language-selection dialog has two pages of options. Use the control dial or the     buttons on the arrow pad to move the cursor between pages.
- 3 Press the  button when the desired language is highlighted.



Using the custom menus

Camera settings can be customized using the  Custom Menu.

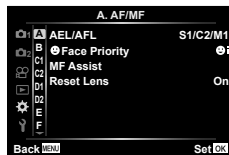

Custom Menu

- A** AF/MF
- B** Button/Dial
- C1/C2** Disp./PC (P. 127)
- D1/D2** Exp/ISO/BULB (P. 128)
- E**  Custom (P. 129)
- F**  WB/Color (P. 129)
- G** Record (P. 130)
- H**  Utility (P. 131)









A AF/MF

MENU →  → **A**

| Option | Description |  |
|--|---|---|
| AEL/AFL | Customize AF and AE lock. | 131 |
|  Face Priority | You can select the face priority or eye priority AF mode. | 71 |
| MF Assist | When set to [On], you can automatically switch to zoom or peaking in manual focus mode by rotating the focus ring. | 132 |
| Reset Lens | When set to [Off], the focus position of the lens is not reset even when the power is turned off. When set to [On], the focus of power zoom lenses is also reset. | — |

B Button/Dial

MENU →  → **B**

| Option | Description |  |
|---|---|---|
| Button Function | Choose the function assigned to the selected button. | 97 |
|  Function | Choose the role played by the  button during playback. [✓]: Select multiple pictures. [O]: Protect pictures. [←]: Mark pictures for sharing. [↓]: Mark pictures for printing at a later date. The number of copies is set to 1. The date is not printed. | 105, 106, 107 |
| Dial Function | You can change the function of the control dial. [P]:  / Ps [A]: FNo. /  [S]: Shutter /  [M]: Shutter / FNo. | — |

| Option | Description | |
|--------------------------|---|----------|
| Control Settings | For each shooting mode except movie, choose whether pressing the button displays live controls or LV super controls. | 76, 77 |
| /Info Settings | Choose the information displayed when the INFO button is pressed. [Info]: Choose the information displayed in full frame playback. [LV-Info]: Choose the information displayed when the camera is in shooting mode. [Settings]: Choose the information displayed in index, "My Clips", and calendar playback. | 132, 133 |
| Live View Boost | [Off]: Changes to settings such as exposure compensation are reflected in the display in the monitor. [On]: Changes to settings such as exposure compensation are not reflected in the display in the monitor; instead, brightness is adjusted to bring the display as close as possible to optimal exposure. | — |
| Flicker reduction | Reduce the effects of flicker under some kinds of lighting, including fluorescent lamps. When flicker is not reduced by the [Auto] setting, set to [50Hz] or [60Hz] in accordance with the commercial power frequency of the region where the camera is used. | — |
| Displayed Grid | Select , , , , or to display a grid on the monitor. | — |
| Peaking Color | Choose the color of the outlines (red, yellow, white, or black) in the focus peaking display. | 132 |

| Option | Description | |
|-----------------|---|-----|
| (Beep sound) | When set to [Off], you can turn off the beep sound that is emitted when the focus locks by pressing the shutter button. • You may need to adjust the settings in the [Silent Settings] menu (P. 117) in order to enable the beep when shooting in the silent mode (P. 75). | — |
| HDMI | [Output Size]: Selecting the digital video signal format for connecting to a TV via an HDMI cable. [HDMI Control]: Select [On] to allow the camera to be operated using remotes for TVs that support HDMI control. This option takes effect when pictures are displayed on a TV. | 134 |
| USB Mode | Choose a mode for connecting the camera to a computer. Choose [Auto] to display USB mode options every time the camera is connected. | — |



| Option | Description |  |
|-----------------------|---|---|
| Exposure Shift | Adjust correct exposure separately for each metering mode. <ul style="list-style-type: none"> This reduces the number of exposure compensation options available in the selected direction. The effects are not visible in the monitor. To make normal adjustments to the exposure, perform exposure compensation (P. 69). | — |
| ISO-Auto Set | Choose the upper limit and default value used for ISO sensitivity when [Auto] is selected for ISO. [High Limit]: Choose the upper limit for auto ISO sensitivity selection. [Default]: Choose the default value for auto ISO sensitivity selection. | — |
| Noise Filter | Choose the amount of noise reduction performed at high ISO sensitivities. | — |
| Noise Reduct. | This function reduces the noise that is generated during long exposures. [Auto]: Noise reduction is performed at slow shutter speeds, or when the internal temperature of the camera has risen. [On]: Noise reduction is performed with every shot. [Off]: Noise reduction off. <ul style="list-style-type: none"> The time required for noise reduction is shown in the display. [Off] is selected automatically during sequential shooting. This function may not work effectively with some shooting conditions or subjects. When shooting in the silent mode, priority is given to the [Noise Reduction [♥]] setting in the [Silent [♥] Settings] menu (P. 117). | 54 |

| Option | Description |  |
|----------------------------|---|---|
| Bulb/Time Timer* | Choose the maximum exposure for bulb and time photography. | 55 |
| Live Bulb | Choose the display interval during shooting. The number of update times is limited. The frequency drops at high ISO sensitivities. Tap the monitor or press the shutter button halfway to refresh the display. Choose [Off] to disable the display. | |
| Live Time* | Choose the display interval during shooting. The number of update times is limited. The frequency drops at high ISO sensitivities. Tap the monitor or press the shutter button halfway to refresh the display. Choose [Off] to disable the display. | 56 |
| Composite Settings* | Set an exposure time to be the reference in composite photography. | |

* Settings for bulb/time maximum exposure and live composite photography apply only in mode **M**.

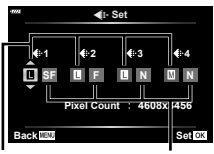
| Option | Description | Icon |
|--------------|---|--------|
| ⚡ X-Sync. | Choose the shutter speed used when the flash fires. | 135 |
| ⚡ Slow Limit | Choose the slowest shutter speed available when a flash is used. | 135 |
| ⊞+⊞ | When set to [On], the exposure compensation value is added to the flash compensation value. | 69, 88 |
| ⚡+WB | Adjust white balance for use with a flash. | — |

| Option | Description | Icon |
|-------------------------|---|---------|
| ⏪- Set | <p>You can select the JPEG image quality mode from combinations of three image sizes and three compression rates.</p> <ol style="list-style-type: none"> 1) Use ⏪⏩ to select a combination ([⏪-1] – [⏪-4]) and use ⏴⏵ to change. 2) Press the OK button. <div style="text-align: center;">  <p>Image size Compression rate</p> </div> | 83, 135 |
| WB | Set the white balance. You can also fine-tune the white balance for each mode. | 80, 90 |
| WB AUTO Keep Warm Color | Select [On] to preserve “warm” colors in pictures taken under incandescent lighting. | — |
| Color Space | You can select a format to ensure that colors are correctly reproduced when shot images are regenerated on a monitor or using a printer. | 95 |

| Option | Description |  |
|-----------------------------------|--|---|
| <p>File Name</p> | <p>[Auto]: Even when a new card is inserted, the file numbers are retained from the previous card. File numbering continues from the last number used or from the highest number available on the card.</p> <p>[Reset]: When you insert a new card, the folder numbers starts at 100 and the file name starts at 0001. If a card containing images is inserted, the file numbers start at the number following the highest file number on the card.</p> | <p>—</p> |
| <p>Edit Filename</p> | <p>Choose how image files are named by editing the portion of the filename highlighted below in gray.</p> <p>sRGB: Pmdd0000.jpg _____ Pmdd Adobe RGB: _mdd0000.jpg _____ mdd</p> <div style="border: 1px solid gray; padding: 5px;"> <ol style="list-style-type: none"> 1) Highlight [sRGB] or [AdobeRGB] and press ▷. 2) Use <▷ to move the cursor and △ ▽ to edit the highlighted character. 3) Repeat Step 2 as necessary to create the desired filename and then press OK. </div> | <p>—</p> |
| <p>Copyright Settings*</p> | <p>Add the names of the photographer and copyright holder to new photographs. Names can be up to 63 characters long.</p> <p>[Copyright Info.]: Select [On] to include the names of the photographer and copyright holder in the Exif data for new photographs.</p> <p>[Artist Name]: Enter the name of the photographer.</p> <p>[Copyright Name]: Enter the name of the copyright holder.</p> <ol style="list-style-type: none"> 1) Select characters from ① and press the OK button. The selected characters appear in ②. 2) Repeat Step 1 to complete the name, then highlight [END] and press the OK button. <ul style="list-style-type: none"> • To delete a character, press the INFO button to place the cursor in the name area ②, highlight the character, and press ⏏. <div style="border: 1px solid black; padding: 5px; margin-top: 10px;">  </div> <p>* OLYMPUS does not accept liability for damages arising from disputes involving the use of [Copyright Settings]. Use at your own risk.</p> | <p>—</p> |

| Option | Description | |
|-----------------------------|---|-----|
| Pixel Mapping | The pixel mapping feature allows the camera to check and adjust the image pickup device and image processing functions. | 155 |
| Level Adjust | You can calibrate the angle of the level gauge. [Reset]: Resets adjusted values to the default settings. [Adjust]: Sets the current camera orientation as the 0 position. | — |
| Touchscreen Settings | Activate the touch screen. Choose [Off] to disable the touch screen. | — |
| Sleep | The camera will enter sleep (energy saving) mode if no operations are performed for the selected period. The camera can be reactivated by pressing the shutter button halfway. | — |
| Certification | Display certification icons. | — |

AEL/AFL

MENU → * → A → [AEL/AFL]

Autofocus and metering can be performed by pressing the button to which AEL/AFL has been assigned. Choose a mode for each focus mode.

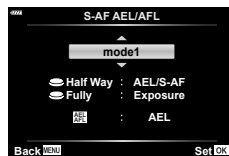

Assignments of AEL/AFL function

| Mode | | Shutter button function | | | | AEL/AFL Button function | |
|------|-------|-------------------------|----------|------------|----------|---------------------------|----------|
| | | Half-press | | Full press | | When holding down AEL/AFL | |
| | | Focus | Exposure | Focus | Exposure | Focus | Exposure |
| S-AF | mode1 | S-AF | Locked | — | — | — | Locked |
| | mode2 | S-AF | — | — | Locked | — | Locked |
| | mode3 | — | Locked | — | — | S-AF | — |
| C-AF | mode1 | C-AF start | Locked | Locked | — | — | Locked |
| | mode2 | C-AF start | — | Locked | Locked | — | Locked |
| | mode3 | — | Locked | Locked | — | C-AF start | — |
| | mode4 | — | — | Locked | Locked | C-AF start | — |
| MF | mode1 | — | Locked | — | — | — | Locked |
| | mode2 | — | — | — | Locked | — | Locked |
| | mode3 | — | Locked | — | — | S-AF | — |

MF Assist

MENU → * → A → [MF Assist]

This is a focus assist function for MF. When the focus ring is rotated, the edge of the subject is enhanced or a portion of the screen display is magnified. When you stop operating the focus ring, the screen returns to the original display.

| | |
|----------------|--|
| Magnify | Magnifies a portion of the screen. The portion to be magnified can be set in advance using AF target. "Setting the AF target" (P. 70) |
| Peaking | Displays clearly defined outlines with edge enhancement. You can choose the color of the outlines. [Peaking Color] (P. 127) |

- When Peaking is in use, the edges of small subjects tend to be enhanced more strongly. This is no guarantee of accurate focusing.

Notes

- [Peaking] can be displayed using button operations. The display is switched every time the button is pressed. Assign the switching function to one of the buttons in advance using Button Function (P. 97).

Adding information displays

MENU → * → G1 → [Info Settings]

Info (Playback information displays)

Use Info to add the following playback information displays. The added displays are displayed by repeatedly pressing the **INFO** button during playback. You can also choose to not show displays that appear at the default setting.



Histogram display



Highlight & Shadow display

- The Highlight & Shadow display shows overexposed areas in red, underexposed areas in blue.



LV-Info (Shooting information displays)

The histogram, Highlight & Shadow, and level gauge displays can be added to [LV-Info]. Choose [Custom 1] or [Custom 2] and select the displays you wish to add. The added displays are displayed by repeatedly pressing the **INFO** button during shooting. You can also choose to not show displays that appear at the default setting.



☒ Settings (Index/calendar display)

You can change the number of frames to be displayed on the index display and set to not display the screens that are set to be displayed by default with [☒ Settings]. Displays indicated by a check mark can be viewed by pressing ☒ repeatedly during playback.

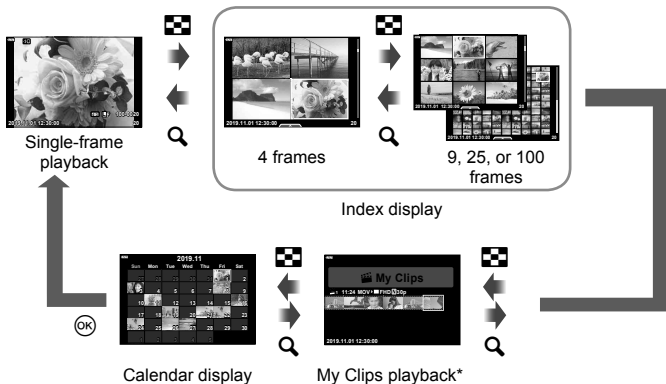

* If one or more My Clips have been created, it will be displayed here (P. 63).

Viewing camera images on TV

MENU → ⚙ → [Q] → [HDMI]

Use the separately sold cable with the camera to playback recorded images on your TV. This function is available during shooting. Connect the camera to an HD TV using an HDMI cable to view high-quality images on a TV screen.

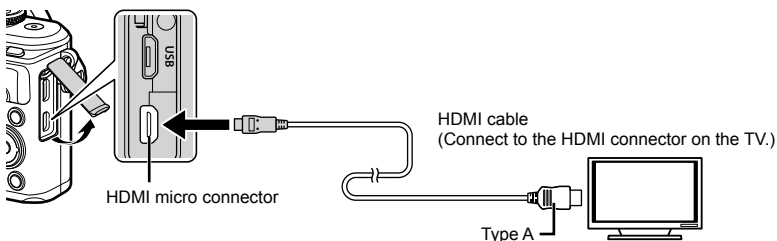

Connect the TV and camera and switch the input source of the TV.

- The camera monitor turns off when an HDMI cable is connected.
- For details on changing the input source of the TV, refer to the TV's instruction manual.
- Depending on the TV's settings, the displayed images and information may become cropped.
- If the camera is connected via an HDMI cable, you will be able to choose the digital video signal type. Choose a format that matches the input format selected with the TV.

| | |
|------------------|---|
| 4K | Priority is given to 4K HDMI output. |
| 1080p | Priority is given to 1080p HDMI output. |
| 720p | Priority is given to 720p HDMI output. |
| 480p/576p | 480p/576p HDMI output. |

- Do not connect the camera to other HDMI output devices. Doing so may damage the camera.
- HDMI output is not performed while connected via USB to a computer.
- When [4K] is selected, video output in shooting mode is [1080p].

Using the TV remote control

The camera can be operated by a TV remote control when connected to a TV that supports HDMI control. Select [On] for [HDMI Control]. When [On] is selected, camera controls can be used for playback only.

- You can operate the camera by following the operation guide displayed on the TV.
- During single-frame playback, you can display or hide the information display by pressing the "Red" button, and display or hide the index display by pressing the "Green" button.
- Some televisions may not support all features.

Shutter speeds when the flash fires

MENU → * → **[]** → [**⚡** X-Sync.]/[**⚡** Slow Limit]

You can set shutter speed conditions for when the flash fires.

| Shooting mode | Flash firing shutter speed | Upper limit | Lower limit |
|---------------|--|--|---|
| P | The camera automatically sets the shutter speed. | [⚡ X-Sync.] setting* ¹ | [⚡ Slow Limit] setting* ² |
| A | | | |
| S | The set shutter speed | | No lower limit |
| M | | | |

*1 1/200 seconds when using a separately sold external flash.

*2 Extends up to 60 seconds when slow synchronization is set.

Combinations of JPEG image sizes and compression rates

MENU → * → **[]** → [**⏪** Set]

You can set the JPEG image quality by combining image size and compression rate.

| Image size | | Compression rate | | |
|-------------------|-------------|--------------------|-------------|---------------|
| Name | Pixel Count | SF (Super Fine) | F (Fine) | N (Normal) |
| L (Large) | 4608×3456 | L SF | L F | L N |
| M (Middle) | 3200×2400 | M SF | M F | M N |
| S (Small) | 1280×960 | S SF | S F | S N |

Use the camera's wireless LAN (Wi-Fi) and **Bluetooth®** features to connect to a smartphone, where you can use the dedicated app to enhancement your enjoyment of the camera both before and after shooting. Once a connection has been established, you can download and take pictures remotely and add GPS tags to the images on the camera.

- Operation is not guaranteed on all smartphones.

Things you can do with the specified app, **OLYMPUS Image Share (OI.Share)**

- Download images from the camera to the smartphone
You can load images in the camera to a smartphone.
You can also use the smartphone to select images for download from the camera.
- Remote shooting from a smartphone
You can remotely operate the camera and shoot using a smartphone.
- Access information to help you enjoy your camera and photography.
You can easily access explanations of photographic techniques (Photo Guide), the Instruction Manual, and the photo-sharing community site even when on the go.

For details, visit the address below:

<http://app.olympus-imaging.com/oishare/>

Things you can do with the specified app, **Olympus Image Palette (OI.Palette)**

- Beautiful image processing
Use intuitive controls to apply impressive effects to images downloaded to your smartphone.

For details, visit the address below:

<http://app.olympus-imaging.com/oipalette/>

Things you can do with the specified app, **OLYMPUS Image Track (OI.Track)**

- Addition of GPS tags to camera images
You can add GPS tags to images simply by transferring the GPS log saved on the smartphone to the camera.



For details, visit the address below:

<http://app.olympus-imaging.com/oitrack/>

- Before using the wireless LAN function, read "Using the wireless LAN/**Bluetooth®** functions" (P. 172).
- Olympus accepts no responsibility for violations of local regulations governing wireless communications caused by the use of the camera's wireless LAN/**Bluetooth®** features outside the country or region of purchase.
- As with any wireless communication, there is always a risk of interception by a third party.
- The wireless LAN function on the camera cannot be used to connect to a home or public access point.
- The transceiver antenna is located inside the grip. Keep the antenna away from metal objects whenever possible.
- Depending on the composition of the container or the objects it contains, the camera may be unable to connect to a smartphone when placed inside a bag or other container.
- During wireless LAN connection, the battery will run down faster. If the battery is running low, the connection may be lost during a transfer.
- Connection may be difficult or slow in proximity to devices that generate magnetic fields, static electricity or radio waves, such as near microwaves, cordless telephone.
- Wireless LAN can not be used when the memory card write-protect switch is in the "LOCK" position.

Pairing the Camera and Smartphone

Follow the steps below when connecting the devices for the first time.

- Adjust pairing settings using OI.Share, not the settings app that is part of the smartphone operating system.
- 1 Launch the copy of the dedicated OI.Share app previously installed on your smartphone.
 - 2 Select [Device Connection] in the  Playback Menu and press the  button.
 - You can also connect by tapping  in the monitor.
 - 3 Follow the on-screen guide to adjust Wi-Fi/**Bluetooth** settings.
 - The **Bluetooth** local name and passcode, the Wi-Fi SSID and password, and a QR code are displayed in the monitor.

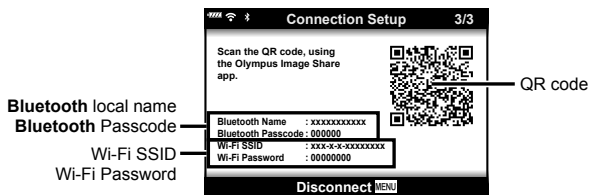

- 4 Tap the camera icon at the bottom of the OI.Share display.
 - An [Easy Setup] tab will be displayed.
- 5 Follow the on-screen instructions in OI.Share to scan the QR code and adjust connection settings.
 - If you are unable to scan the QR code, follow the on-screen instructions in OI.Share to adjust settings manually.
 - **Bluetooth:** To connect, select the local name and enter the passcode displayed in the camera monitor into the **Bluetooth** settings dialog in OI.Share.
 - Wi-Fi: To connect, enter the SSID and password displayed on the camera monitor into the Wi-Fi settings dialog in OI.Share.
 -  1 will be displayed when pairing is complete.
- 6 To end the connection, press **MENU** on the camera or tap [Disconnect] on the monitor screen.
 - You can also turn the camera off and end the connection from OI.Share.

Wireless Settings for When the Camera Is Off

You can choose whether the camera will maintain a wireless connection to the smartphone when off.

- 1 Highlight [Wi-Fi/Bluetooth Settings] in the \uparrow setup menu and press the \odot button.
- 2 Highlight [Power-off Standby] and press \triangleright .
- 3 Highlight the desired option and press the \odot button.

| | |
|---------------|---|
| Select | When the ON/OFF button is pressed to turn the camera off, a confirmation dialog will be displayed asking the user if they wish the wireless connection to the smartphone to remain active. |
| Off | Turning the camera off terminates the wireless connection to the smartphone. |
| On | When the camera is turned off, the connection to the smartphone remains active and the smartphone can still be used to download or view the pictures on the camera. |

■ “Select”

When [Select] is chosen for [Power-off Standby], a confirmation dialog will be displayed before the camera turns off if all the following conditions are met:

- [On] is selected for [Wi-Fi/Bluetooth Settings]
- The camera is currently connected with a smartphone (P. 137)
- The memory card is correctly inserted

| | |
|------------|--|
| Yes | Turn the camera off but leave the wireless smartphone connection active. |
| No | Turn the camera off and terminate the wireless smartphone connection. |

- If you press the **ON/OFF** button while the confirmation dialog is displayed, the camera will terminate the wireless smartphone connection before turning off.
- The first time you turn the camera off after connecting to a smartphone (P. 137), you may be prompted to choose whether to hide the confirmation dialog in future. To keep the camera from displaying the confirmation dialog when turned off in future, select [Don't show this screen again].

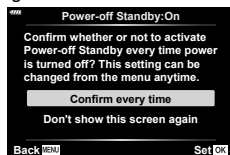
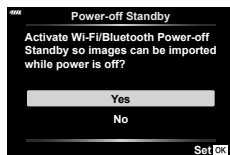



Notes



- If left active, the wireless connection will automatically terminate if:
 - the connection remains inactive for 24 hours
 - the memory card is removed
 - the camera is connected to a computer via USBThe connection can be restored by turning the camera on.
- When [On] is selected for [Power-off Standby], the camera may not immediately turn on when the **ON/OFF** button is pressed. If the camera does not turn on, press the **ON/OFF** button again.

Transferring images to a smartphone

You can select images in the camera and load them to a smartphone. You can also use the camera to select images you want to share in advance. 📱 “Setting a transfer order on images (Share Order)” (P. 106)

1 Launch the dedicated OI.Share app on the smartphone.

2 Start [Device Connection] on the camera (P. 137).

- You can also connect by tapping  in the monitor.
- If you have previously connected to the smartphone, the camera will start the connection automatically.
-  1 will be displayed when pairing is complete.

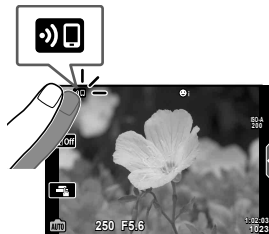

3 Tap [Import Photos] in OI.Share on the smartphone.

- The images in the camera are displayed in a list.

4 Select the pictures you want to transfer and tap the Save button.

- When saving is completed, you can turn off the camera from the smartphone.

Notes

- If the following options are selected for [Wi-Fi/Bluetooth settings] in the camera  (setup menu), you can download pictures to the smartphone as described in Steps 3 and 4, above, even when the camera is off:
 - [Availability]: [On]
 - [Power-off standby]: [On]

Automatically uploading images while the camera is off

To configure the camera to automatically upload images to a smartphone while off:



- Mark images for sharing (P. 106)
- Enable power-off standby (P. 138)
- If you are using an iOS device, launch OI.Share

Notes

- Auto upload is not available if you are connected via a router (for example, a home network), in which case you will need to transfer pictures using OI.Share.
- Some smartphones may terminate upload on entering sleep mode. Keep the smartphone awake while upload is in progress.



Shooting remotely with a smartphone

You can shoot remotely by operating the camera with a smartphone.

- 1 Launch the dedicated OI.Share app on the smartphone.
 - 2 Start [Device Connection] on the camera (P. 137).
 - You can also connect by tapping  in the monitor.
 - If you have previously connected to the smartphone, the camera will start the connection automatically.
 -  will be displayed when pairing is complete.
 - 3 Tap [Remote Control] in OI.Share on the smartphone.
 - 4 Tap the shutter button to shoot.
 - The image taken is saved on the memory card in the camera.
- Available shooting options are partially limited.





Adding position information to images

You can add GPS tags to images that were taken while the GPS log was saving by transferring the GPS log saved on the smartphone to the camera.

- 1 Before taking pictures with the camera, launch OI.Track on the smartphone to begin saving the GPS log.
 - Before starting a GPS track log, you will need to connect once via OI.Track and synchronize the clock.
 - You can use the phone or other apps while the GPS log is saving. Do not terminate OI.Track.
 - 2 Once you have finished taking pictures with the camera, end tracking in OI.Share.
 - 3 Tap the  icon in the camera monitor to connect to the smartphone.
 - You can also connect by selecting [Device Connection] in the  playback menu.
 - 4 Upload the GPS log to the camera using OI.Track.
 - The GPS log will be used to add location data to any pictures taken after you launched OI.Track in Step 1.
 -  is displayed on images to which position information has been added.
- Addition of location information can only be used with smartphones that have a GPS function.
 - Position information cannot be added to movies.

Resetting wireless LAN/Bluetooth® settings

To restore [Wi-Fi/Bluetooth Settings] to default values:





- 1 Select [Wi-Fi/Bluetooth Settings] in the  Setup Menu and press the  button.
- 2 Select [Reset Settings] and press .
- 3 Select [Yes] and press the  button.
 - The following settings will be reset:

| Option | Default |
|---------------------|--------------------------|
| Availability | On |
| Connection Password | — (generated randomly) * |
| Power-off Standby | Select * |

* The connection to the smartphone will also be reset (deactivated).

Changing the password

To change the Wi-Fi/**Bluetooth** passwords:

- 1 Select [Wi-Fi/Bluetooth Settings] in the  Setup Menu and press the  button.
- 2 Select [Connection Password] and press .
- 3 Follow the operation guide and press the  button.
 - A new password will be set.
 - Both the Wi-Fi connection password and **Bluetooth** connection passcode can be changed.
 - Reconnect to the smartphone after changing passwords.  "Pairing the Camera and Smartphone" (P. 137)

Disabling wireless LAN/Bluetooth®

To disable wireless LAN/**Bluetooth**®:

- 1** Select [Wi-Fi/Bluetooth Settings] in the **Y** Setup Menu and press the **OK** button.
- 2** Select [Availability] and press **▷**.
- 3** Select [Off] and press the **OK** button.



Notes

- To disable wireless LAN/**Bluetooth**® only while the camera is off, select [Off] for [Wi-Fi/Bluetooth Settings] > [Power-off Standby]. "Wireless Settings for When the Camera Is Off" (P. 138)

Connecting the camera to a computer

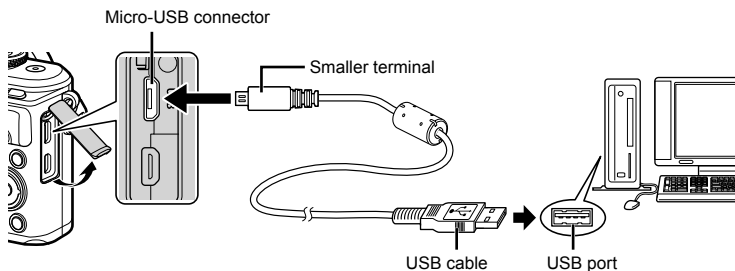

- When the camera is connected to a computer via USB, a dialog should be displayed in the monitor prompting you to choose a host. If it is not, select [Auto] for [USB Mode] (P. 127) in the camera custom menus.
- If nothing is displayed on the camera screen even after connecting the camera to the computer, the battery may be exhausted. Use a full-charged battery.

Copying pictures to a computer

The following operating systems are compatible with the USB connection:

Windows: Windows 7 SP1/Windows 8/Windows 8.1/Windows 10

Mac: OS X v10.9-v10.11/macOS v10.12-v10.14

- 1 Turn the camera off and connect it to the computer.
 - The location of the USB port varies with the computer. For details, refer to your computer's manual.
 - The selection screen for the USB connection is displayed.
- 2 Press Δ ∇ to select [Storage]. Press the \odot button.



- 3 The computer recognizes the camera as a new device.
 - Data transfer is not guaranteed in the following environments, even if your computer is equipped with a USB port.
 - Computers with a USB port added by means of an extension card, etc., computers without a factory-installed OS, or home-built computers
 - Camera controls cannot be used while the camera is connected to a computer.
 - If the dialog shown in Step 2 is not displayed when the camera is connected to a computer, select [Auto] for [USB Mode] (P. 127) in the camera custom menus.

Installing the PC software

The photographs and movies you have shot with your camera can be transferred to a computer and viewed, and edited using the Olympus Workspace offered by OLYMPUS.

- To install Olympus Workspace, download it from <https://support.olympus-imaging.com/owdownload/> and follow the on-screen instructions.
- Visit the website above for system requirements and installation instructions.
- You will be required to enter the product serial number prior to download.

User Registration

Visit the OLYMPUS website for information on registering your OLYMPUS products.

Battery and charger

- The camera uses a single Olympus lithium-ion battery. Never use any battery other than genuine OLYMPUS batteries.
- The camera's power consumption varies widely with usage and other conditions.
- As the following consume a lot of power even without shooting, the battery will be drained quickly.
 - Performing auto focus repeatedly by pressing the shutter button halfway in shooting mode.
 - Displaying images on the monitor for a prolonged period.
 - When connected to a computer.
 - Leaving wireless LAN/**Bluetooth**® enabled.
- When using a drained battery, the camera may turn off without the low battery warning being displayed.
- Remove the batteries before putting the camera into storage for periods of a month or more.

Leaving the batteries in the camera for extended periods shortens their lives, potentially rendering them unusable.
- The battery will not be fully charged at the time of purchase. Charge the battery using the provided charger before use.
- The normal charging time using the provided charger is approximately 3 hours 30 minutes (estimated).
- Do not attempt to use chargers not specifically designated for use with the supplied battery, or to use batteries not specifically designated for use with the supplied charger.
- There is a risk of explosion if the battery is replaced with the incorrect battery type.
- Dispose of the used battery following the instructions "CAUTION" (P. 171) in the instruction manual.

Using your charger abroad

- The charger can be used in most home electrical sources within the range of 100V to 240V AC (50/60 Hz) around the world. However, depending on the country or area you are in, the AC wall outlet may be shaped differently and the charger may require a plug adapter to match the wall outlet.
- Do not use commercially available travel adapters as the charger may malfunction.

Usable cards

In this manual, all storage devices are referred to as “cards.” The following types of SD memory card (commercially available) can be used with this camera: SD, SDHC, and SDXC. For the latest information, please visit the Olympus website.



SD card write protect switch

The SD card body has a write protect switch. Setting the switch to “LOCK” prevents data being written to the card. Return the switch to the unlock position enable writing.

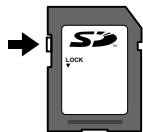

- Cards must be formatted with this camera before first use or after being used with other cameras or computers. “Formatting the card (Card Setup)” (P. 125)
- The data in the card will not be erased completely even after formatting the card or deleting the data. When discarding, destroy the card to prevent leakage of personal information.

Record mode and file size/number of storable still pictures

The file size in the table is approximate for files with a 4:3 aspect ratio.

| Record mode | Image size (Pixel Count) | Compression | File format | File size (MB) | Number of storable still pictures* |
|-------------|--------------------------|-----------------------|-------------|----------------|------------------------------------|
| RAW | 4608×3456 | Loss-less compression | ORF | Approx. 17.4 | 867 |
| SF | | 1/2.7 | | Approx. 10.4 | 1326 |
| F | | 1/4 | | Approx. 7.1 | 1944 |
| N | | 1/8 | | Approx. 3.7 | 3783 |
| MSF | 3200×2400 | 1/2.7 | JPEG | Approx. 5.1 | 2696 |
| F | | 1/4 | | Approx. 3.6 | 3905 |
| N | | 1/8 | | Approx. 1.9 | 7395 |
| SF | | 1/2.7 | | Approx. 1.0 | 13559 |
| F | 1280×960 | 1/4 | | Approx. 0.8 | 18079 |
| N | | 1/8 | | Approx. 0.5 | 28713 |

* Assumes a 16GB SD card.

- The number of storable still pictures may change according to the subject, whether or not print reservations have been made, and other factors. In certain instances, the number of storable still pictures displayed on the monitor will not change even when you take pictures or erase stored images.
- The actual file size varies according to the subject.
- The maximum number of storable still pictures displayed on the monitor is 9999.
- For the available recording time for movies, see the Olympus website.

Interchangeable lenses

Choose a lens according to the scene and your creative intent. Use lenses designed exclusively for the Micro Four Thirds system and bearing the M.ZUIKO DIGITAL label or the symbol shown at right. With an adapter, you can also use Four Thirds System and OM System lenses. The optional adapter is required.



- When you attach or remove the body cap and lens from the camera, keep the lens mount on the camera pointed downward. This helps prevent dust and other foreign matter from getting inside the camera.
- Do not remove the body cap or attach the lens in dusty places.
- Do not point the lens attached to the camera toward the sun. This may cause the camera to malfunction or even ignite due to the magnifying effect of sunlight focusing through the lens.
- Be careful not to lose the body cap and rear cap.
- Attach the body cap to the camera to prevent dust from getting inside when no lens is attached.

■ Lens and camera combinations

| Lens | Camera | Attachment | AF | Metering |
|-------------------------------|---------------------------------|--|-------|----------|
| Micro Four Thirds system lens | Micro Four Thirds system camera | Yes | Yes | Yes |
| Four Thirds system lens | | Attachment possible with mount adapter | Yes*1 | Yes |
| OM System lenses | | | No | Yes*2 |

*1 AF is not operational when recording movies.

*2 Accurate metering is not possible.

Compatible Flash Units

Choose a flash unit to suit your needs, taking into consideration such factors as the output required and whether the unit supports macro photography. Flash units designed to communicate with the camera support a variety of flash modes, including TTL auto and super FP. Flash units can be mounted on the camera hot shoe or connected using a cable (available separately) and flash bracket. See the documentation provided with the flash unit for information on flash features and their use. The camera also supports the following wireless flash control systems:

Radio-Controlled Flash Photography: CMD, ⚡CMD, RCV, and X-RCV Modes

The camera controls one or more remote flash units by means of radio signals. The range of locations in which flash units can be placed increases. Flash units can control other compatible units or be fitted with radio commander/receivers to allow the use of units that do not otherwise support radio flash control.

Wireless Remote-Control Flash Photography: RC Mode

The camera controls one or more remote flash units by means of optical signals. The flash mode can be selected using camera controls (P. 72).

■ Functions available with external flash units



| Flash unit | Flash control mode | GN (Guide number) (ISO100) | Supported wireless systems |
|-----------------|---|---|---------------------------------|
| FL-700WR | TTL-AUTO, MANUAL, FP TTL AUTO, FP MANUAL, MULTI, RC, SL MANUAL | GN 42 (150 mm ^{*1}) GN 21 (24 mm ^{*1}) | CMD, ⚡CMD, RCV, X-RCV, RC |
| FL-900R | TTL-AUTO, AUTO, MANUAL, FP TTL AUTO, FP MANUAL, MULTI, RC, SL AUTO, SL MANUAL | GN58 (200 mm ^{*1}) | RC |
| FL-600R | TTL-AUTO, AUTO, MANUAL, FP TTL AUTO, FP MANUAL | GN36 (85 mm ^{*1}) GN20 (24 mm ^{*1}) | RC |
| FL-300R | TTL-AUTO, MANUAL | GN20 (28 mm ^{*1}) | RC |
| FL-14 | TTL-AUTO, AUTO, MANUAL | GN14 (28 mm ^{*1}) | RC |
| STF-8 | TTL-AUTO, MANUAL | GN8.5 | RC ^{*2} |

*1 The focal length of the lens that can be used (Calculated based on 35 mm film camera).

*2 Functions as commander (transmitter) only.

Wireless remote control flash photography

External flash units that are designated for use with this camera and have a remote control mode can be used for wireless flash photography. The camera can separately control each of three groups of remote flash units, and the internal flash. See the instruction manuals provided with the external flash units for details.

- 1 Set the remote flash units to RC mode and place them as desired.
 - Turn the external flash units on, press the MODE button, and select RC mode.
 - Select a channel and group for each external flash unit.
- 2 Select [On] for [⚡ RC Mode] in  Shooting Menu 2 (P. 114).
 - Press the  button to exit to the RC mode display. Press the **INFO** button to cycle between LV super controls or live controls and the RC mode display.
 - Select a flash mode (note that red-eye reduction is not available in RC mode).
- 3 Adjust the settings for each group in the RC mode display.

Group

- Select the flash control mode and adjust the flash intensity separately for each group. For MANUAL, select the flash intensity.

Adjust settings for the camera flash unit.

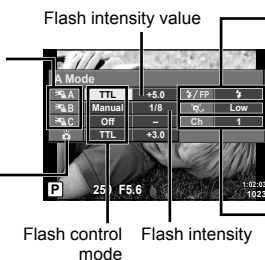

Normal flash/Super FP flash
• Switch between normal flash and Super FP flash.

Communication light level
• Set the communication light level to [HI], [MID], or [LO].

Channel
• Set the communication channel to the same channel used on the flash.

- 4 Press the flash pop-up button to raise the flash.
 - After confirming that the flash has charged, take a test shot.

■ Wireless flash control range

Position the wireless flash units with their remote sensors facing the camera. The following illustration shows the approximate ranges at which the flash units can be positioned. The actual control range varies with local conditions.

- We recommend using a single group of up to three remote flash units.
- Remote flash units cannot be used for second curtain slow synchronization exposures longer than 4 seconds.
- If the subject is too close to the camera, the control flashes emitted by the camera flash may affect exposure (this effect can be reduced by reducing the output of the camera flash by, for example, using a diffuser).
- The upper limit of flash synchronization timing is 1/160 sec. when using the flash in RC mode.

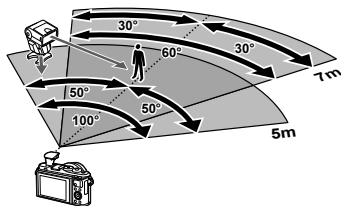

Other external flash units

Note the following when using a third-party flash unit mounted on the camera hot shoe:

- Using obsolete flash units that apply currents of more than about 24 V to the X-contact will damage the camera.
- Connecting flash units with signal contacts that do not conform to Olympus specifications may damage the camera.
- Set the Shooting mode to **M**, set the shutter speed to a value no higher than flash synchronous speed, and set ISO sensitivity to a setting other than [AUTO].
- Flash control can only be performed by manually setting the flash to the ISO sensitivity and aperture values selected with the camera. Flash brightness can be adjusted by adjusting either ISO sensitivity or aperture.
- Use a flash with an angle of illumination suited to the lens. Angle of illumination is usually expressed using 35-mm format equivalent focal lengths.

System chart

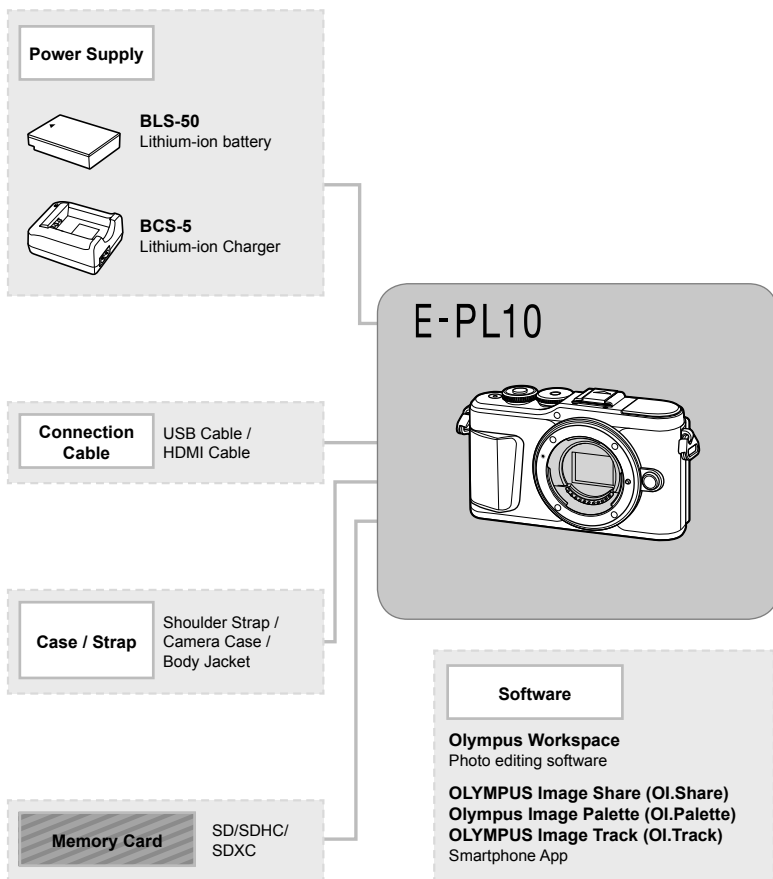

□ : E-PL10 compatible products
▨ : Commercially available products
For the latest information, please visit the Olympus website.

*1 Not all lenses can be used with adapter. For details, refer to the Olympus Official Web Site. Also, please note that manufacture of OM System Lenses has been discontinued.
*2 For compatible lens, refer to the Olympus Official Web Site.

Flash

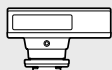

FL-14
Electronic Flash



FL-900R
Electronic Flash



FL-700WR
Electronic Flash



FL-300R
Electronic Flash



FL-600R
Electronic Flash

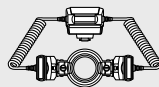

STF-8
Macro Flash

Lens

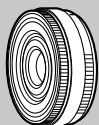

Micro Four Thirds system lenses



MMF-2/MMF-3¹
Four Thirds Adapter



MF-2¹
OM Adapter 2



BCL-1580/BCL-0980
Body Cap Lens

Four Thirds System Lenses

OM System Lenses

Converter Lens²

FCON-P01
Fisheye

WCON-P01
Wide

MCON-P01
Macro

MCON-P02
Macro

MC-14
Teleconverter

Cleaning and storing the camera

Cleaning the camera

Turn off the camera and remove the battery before cleaning the camera.

- Do not use strong solvents such as benzene or alcohol, or a chemically treated cloth.

Exterior:

- Wipe gently with a soft cloth. If the camera is very dirty, soak the cloth in mild soapy water and wring well. Wipe the camera with the damp cloth and then dry it with a dry cloth. If you have used the camera at the beach, use a cloth soaked in clean water and well wrung.

Monitor:

- Wipe gently with a soft cloth.

Lens:

- Blow dust off the lens with a commercially available blower. For the lens, wipe gently with a lens cleaning paper.

Storage

- When not using the camera for a prolonged period, remove the battery and card. Store the camera in a cool, dry place that is well ventilated.
- Insert the battery periodically and test the camera's functions.
- Remove dust and other foreign matter from the body and rear caps before attaching them.
- Attach the body cap to the camera to prevent dust from getting inside when no lens is attached. Be sure to replace the front and rear lens caps before putting the lens away.
- Clean the camera after use.
- Do not store with insect repellent.
- Avoid storing the camera in places where chemicals are treated, in order to protect the camera from corrosion.
- Mold may form on the lens surface if the lens is left dirty.
- Check each part of the camera before use if it has not been used for a long time. Before taking important pictures, be sure to take a test shot and check that the camera works properly.

Cleaning and checking the image pickup device

This camera incorporates a dust reduction function to keep dust from getting on the image pickup device and to remove any dust or dirt from the image pickup device surface with ultrasonic vibrations. The dust reduction function operates when the camera is turned on.

The dust reduction function operates at the same time as the pixel mapping, which checks the image pickup device and image processing circuitry. Since dust reduction is activated every time the camera's power is turned on, the camera should be held upright for the dust reduction function to be effective.

Pixel Mapping - Checking the image processing functions

The pixel mapping feature allows the camera to check and adjust the image pickup device and image processing functions. Before using the pixel mapping function to ensure that it operates correctly, wait for 1 minute or longer immediately after shooting or playback.

- 1 In Custom Menu **H**, select [Pixel Mapping] (P. 131).
- 2 Press **▶**, then press the **OK** button.
 - The [Busy] bar is displayed when pixel mapping is in progress. When pixel mapping is finished, the menu is restored.
 - If you accidentally turn the camera off during pixel mapping, start again from Step 1.

Shooting tips and information

The camera does not turn on even when a battery is loaded

The battery is not fully charged

- Charge the battery with the charger.

The battery is temporarily unable to function because of the cold

- Battery performance drops at low temperatures. Remove the battery and warm it by putting it in your pocket for a while.

A language-selection prompt is displayed

The dialog shown in the illustration will be displayed in the following circumstances:

- The camera is turned on for the first time
- You previously ended initial setup without choosing a language

Choose a language as described in "Initial setup" (P. 21).

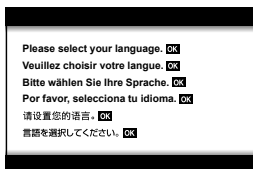

No picture is taken when the shutter button is pressed

The camera has turned off automatically

- The camera automatically enters sleep mode to reduce the drain on the battery if no operations are performed for a set period of time.  [Sleep] (P. 131)
 Press the shutter button halfway to exit the sleep mode.
 The camera will turn off automatically if left in sleep mode for 5 minutes.

The flash is charging

- On the monitor, the  mark blinks when charging is in progress. Wait for the blinking to stop, then press the shutter button.

Unable to focus

- The camera cannot focus on subjects that are too close to the camera or that are not suited to autofocus (the AF confirmation mark will blink in the monitor). Increase the distance to the subject or focus on a high contrast object at the same distance from the camera as your main subject, compose the shot, and shoot.

Subjects that are difficult to focus on

It may be difficult to focus with auto focus in the following situations.

AF confirmation mark is blinking. These subjects are not focused.



Subject with low contrast



Excessively bright light in center of frame

AF confirmation mark lights up but the subject is not focused.



Subjects at different distances

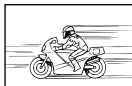

Fast-moving subject



Subject not inside AF area

Noise reduction is activated

- When shooting night scenes, shutter speeds are slower and noise tends to appear in images. The camera activates the noise-reduction process after shooting at slow shutter speeds. During which, shooting is not allowed. You can set [Noise Reduct.] to [Off].  [Noise Reduct.] (P. 128)

The number of AF targets is reduced

The size and number of the AF targets changes with the aspect ratio (P. 83), the AF target mode (P. 70), and the option selected for [Digital Tele-converter] (P. 115).

The date and time has not been set

The camera is used with the settings at the time of purchase

- The date and time of the camera is not set when purchased. Set the date and time before using the camera.  "Initial setup" (P. 21)

The battery has been removed from the camera

- The date and time settings will be returned to the factory default settings if the camera is left without the battery for approximately 1 day. The settings will be canceled more quickly if the battery was only loaded in the camera for a short time before being removed. Before taking important pictures, check that the date and time settings are correct.

Set functions are restored to their factory default settings



When you rotate the mode dial or turn off the power in a shooting mode other than **P**, **A**, **S**, **M**, or , any settings you have altered will be reset to default values.

Image taken appears whitish

This may occur when the picture is taken in backlight or semi-backlight conditions. This is due to a phenomenon called flare or ghosting. As far as possible, consider a composition where strong light source is not taken in the picture. Flare may occur even when a light source is not present in the picture. Use a lens hood to shade the lens from the light source. If a lens hood does not have effect, use your hand to shade the lens from the light.

 "Interchangeable lenses" (P. 148)

Unknown bright dot(s) appear on the subject in the picture taken

This may be due to stuck pixel(s) on the image pickup device. Perform [Pixel Mapping]. If the problem persists, repeat pixel mapping a few times.  "Pixel Mapping - Checking the image processing functions" (P. 155)

The subject appears distorted

The following functions use an electronic shutter:

movie recording (P. 58)/silent (P. 75)/the **SCN** mode panorama (P. 35), "silent" (P. 35), and "multi-focus shot" (P. 36) options/the **IAF** mode "silent" (P. 42), panorama (P. 43), and "focus bracketing" (P. 46) options

This may cause distortion if the subject is moving rapidly or the camera is moved abruptly. Avoid moving the camera abruptly during shooting or use standard sequential shooting.

Lines appear in photographs

The following functions use an electronic shutter, which may result in lines due to flicker and other phenomena associated with fluorescent and LED lighting, an effect that can sometimes be reduced by choosing slower shutter speeds:

movie recording (P. 58)/silent (P. 75)/the **SCN** mode panorama (P. 35), "silent" (P. 35), and "multi-focus shot" (P. 36) options/the **IAF** mode "silent" (P. 42), panorama (P. 43), and "focus bracketing" (P. 46) options

The camera is stuck in manual focus (MF) mode

Some lenses are equipped with a manual focus clutch that engages manual focus when the focus ring is slid back. Check the lens. More information can be found in the lens manual.

Changing the number of frames or adding frames to the index playback display

Use the [Info Settings] > [Settings] option in custom menu **C1** to change the number of frames shown in or add frames to the index playback display (P. 133).

Hiding menu guides

Press the **INFO** button to hide or show on-screen guides in the menu display (P. 113).











Viewing the functions assigned to dials and buttons



Use the options in Custom Menu **B** to view the functions assigned to camera controls.
[Button Function] (P. 126)/[Function] (P. 126)/[Dial Function] (P. 126)

Movies do not play back smoothly when viewed on a TV

The movie frame rate may not match the video standard used in the TV. View the movie on a computer instead. Before recording movies for display on a TV, choose a frame rate that matches the video standard used in the device. [Video Frame Rate] (P. 119)

Error codes

| Monitor indication | Possible cause | Corrective action |
|--|--|--|
|  No Card | The card is not inserted, or it cannot be recognized. | Insert a card or insert a different card. |
|  Card Error | There is a problem with the card. | Insert the card again. If the problem persists, format the card. If the card cannot be formatted, it cannot be used. |
|  Write Protect | Writing to the card is prohibited. | The card write-protect switch is set to the "LOCK" side. Release the switch. (P. 147) |
|  Card Full | <ul style="list-style-type: none"> The card is full. No more pictures can be taken or no more information such as print reservation can be recorded. There is no space in the card and print reservation or new images cannot be recorded. | Replace the card or erase unwanted pictures. Before erasing, download important images to a PC. |
|  No Picture | There are no pictures on the card. | The card contains no pictures. Record pictures and play back. |
|  Picture Error | The selected picture cannot be displayed for playback due to a problem with this picture. Or the picture cannot be used for playback on this camera. | Use image processing software to view the picture on a PC. If that cannot be done, the image file is damaged. |
|  The Image Cannot Be Edited | Pictures taken with another camera cannot be edited on this camera. | Use image processing software to edit the picture. |
| Y/M/D | The clock is not set. | Set the clock (P. 22). |
|  | | Turn off the camera and wait for the internal temperature to cool. |
|  Internal camera temperature is too high. Please wait for cooling before camera use. | The internal temperature of the camera has risen due to sequential shooting. | Wait a moment for the camera to turn off automatically. Allow the internal temperature of the camera to cool before resuming operations. |
|  Battery Empty | The battery is drained. | Charge the battery. |

| Monitor indication | Possible cause | Corrective action |
|--|---|---|
|  No Connection | The camera is not correctly connected to a computer, HDMI display, or other device. | Reconnect the camera. |
|  Cannot Print | It may not be possible to create print reservations for pictures recorded on other cameras via this camera. | Print separately via a personal computer, etc. |
| The lens is locked. Please extend the lens. | The lens of the retractable lens stays retracted. | Extend the lens. |
| Please check the status of a lens. | An abnormality has occurred between the camera and the lens. | Turn off the camera, check the connection with the lens, and turn the power on again. |
| This function requires a compatible lens. Please attach a compatible lens. | The lens does not support the selected shooting mode. | Choose a lens that does or choose a different shooting mode. |

Defaults

*1: Default can be restored by selecting [Full] for [Reset].

*2: Default can be restored by selecting [Basic] for [Reset].

Button Functions/Live Control/LV Super Control

| Function | Default | *1 | *2 | |
|--------------------------------|---------------------------|----|----|-----|
| ISO | AUTO | ✓ | ✓ | 79 |
| Sequential shooting/Self-timer | | ✓ | ✓ | 74 |
| AF target settings | | ✓ | ✓ | 70 |
| Flash photography | | ✓ | ✓ | 72 |
| AF mode | S-AF | ✓ | ✓ | 81 |
| AF mode | C-AF | ✓ | ✓ | 119 |
| Aspect ratio | 4:3 | ✓ | ✓ | 83 |
| | L F | ✓ | ✓ | 83 |
| (Standard) | 1920×1080 Fine 60p | ✓ | ✓ | 84 |
| (4K) | 3840×2160 30p | — | — | 85 |
| (Clips) | 1920×1080 Normal 60p 4s | ✓ | ✓ | 86 |
| (High-speed) | 1280×720 HighSpeed 120fps | — | — | 86 |
| Movie (exposure) mode | P | ✓ | — | 87 |

Shooting Menu

| Tab | Function | Default | *1 | *2 | | |
|------------|------------------------|--------------------|-----------|-----|---------|-----|
| | Reset | Basic | — | — | 114 | |
| | Picture Mode | Natural | ✓ | ✓ | 78, 115 | |
| | Digital Tele-converter | Off | ✓ | ✓ | 115 | |
| | Metering | | ✓ | ✓ | 91 | |
| | Image Stabilizer | S-IS On | ✓ | ✓ | 89 | |
| | AF Illuminator | On | ✓ | ✓ | 115 | |
| | Elec. Zoom Speed | Normal | ✓ | — | 116 | |
| | | ±0.0 | ✓ | ✓ | 88 | |
| | Intrvl. Sh./Time Lapse | Off | ✓ | ✓ | 116 | |
| | Silent [] Settings | Noise Reduction [] | Off | ✓ | ✓ | 117 |
| | | | Not Allow | ✓ | ✓ | |
| | | AF Illuminator | Not Allow | ✓ | ✓ | |
| Flash Mode | | Not Allow | ✓ | ✓ | | |
| RC Mode | Off | ✓ | ✓ | 118 | | |

📷 Video Menu

| Tab | Function | Default | *1 | *2 | 👉 |
|-----|--------------------|---------|----|----|---------|
| 📷 | Movie 🎤 | On | ✓ | ✓ | 119 |
| | Recording Volume | ±0 | ✓ | — | 119 |
| | 📷 AF Mode | C-AF | ✓ | ✓ | 119 |
| | 📷 Image Stabilizer | M-IS 1 | ✓ | ✓ | 89 |
| | 📷 Elec. Zoom Speed | Normal | ✓ | — | 119 |
| | Video Frame Rate | 30p | ✓ | — | 84, 119 |
| | Video Bit Rate | Fine | ✓ | — | 84, 119 |

▶ Playback Menu

| Tab | Function | Default | *1 | *2 | 👉 | | |
|-------------------|----------|----------------|---------------|----------|-----|-----|----------|
| ▶ | 📄 | Start | — | — | — | | |
| | | BGM | Happy Days | ✓ | ✓ | 104 | |
| | | Slide | All | ✓ | ✓ | | |
| | | Slide Interval | 3 sec | ✓ | — | | |
| | | Movie Interval | Short | ✓ | — | | |
| | 📷 | On | ✓ | ✓ | 120 | | |
| | Edit | Sel. Image | RAW Data Edit | — | — | — | 120 |
| | | | JPEG Edit | — | | | 121 |
| | | | Movie Edit | — | | | 122, 123 |
| | | 🎤 | — | 108, 121 | | | |
| Image Overlay | — | — | — | 122 | | | |
| Print Order | — | — | — | 107 | | | |
| Reset Protect | — | — | — | 123 | | | |
| Reset share Order | — | — | — | 106 | | | |
| Device Connection | — | — | — | 137 | | | |

⚙️ Custom Menu

| Tab | Function | Default | *1 | *2 | 👉 | | |
|------------|-----------------|-----------------|-------------|----------------|----------|-------|---------|
| ⚙️ | AF/MF | | ✓ | ✓ | 126, 131 | | |
| | A | S-AF | | | | mode1 | |
| | | AEL/AFL | | | | C-AF | mode2 |
| | | | | | | MF | mode1 |
| | ☉ Face Priority | ☉ | | | | ✓ | — |
| | MF Assist | Magnify | Off | ✓ | — | 126, | |
| | | Peaking | Off | ✓ | — | 132 | |
| | Reset Lens | On | ✓ | ✓ | 126 | | |
| | Button/Dial | | | | | | |
| | B | Button Function | Fn Function | Q ² | ✓ | — | 97, 126 |
| ☉ Function | | | ☉ REC | ✓ | — | | |
| | ▶ ☉ Function | 🔗 | ✓ | — | 126 | | |
| | Dial Function | P | 📷 | ✓ | — | 126 | |
| | | A | FNo. | | | | |
| | | S | Shutter | | | | |
| | | M | Shutter | | | | |

| Tab | Function | | Default | *1 | *2 | | |
|---------------|--------------------|------------------|--------------|------------------------------------|---------|-------------|----------|
| | Disp/■)))/PC | | | | | | |
| | C1 | Control Settings | Auto | LV-C | ✓ | — | 77, 127 |
| | | | P/A/S/M | LV-C | ✓ | — | |
| | | | ART | LV-C | ✓ | — | |
| | | | SCN/)/AP) | LV-C | ✓ | — | |
| | | /Info Settings | Info | Image Only, Overall | ✓ | ✓ | 127, 132 |
| | | | LV-Info | Custom1 () , Custom2 (Level Gauge) | ✓ | — | |
| | | | Settings | 25, My Clips, Calendar | ✓ | — | |
| | Live View Boost | | Off | ✓ | ✓ | 127 | |
| | Flicker reduction | | Auto | ✓ | — | 127 | |
| | Displayed Grid | | Off | ✓ | — | 127 | |
| | Peaking Color | | Red | ✓ | — | 127 | |
| | C2 | | | On | ✓ | ✓ | 127 |
| | | HDMI | Output Size | 1080p | ✓ | — | 127, |
| | | | HDMI Control | Off | ✓ | — | 134 |
| | | USB Mode | | Auto | ✓ | ✓ | 127 |
| | Exp/ISO/BULB | | | | | | |
| | D1 | Exposure Shift | | ±0 | ✓ | — | 128 |
| | | | | | | | |
| | | | | | | | |
| ISO-Auto Set | | High Limit | 6400 | ✓ | ✓ | 128 | |
| | | Default | 200 | ✓ | ✓ | | |
| Noise Filter | | Standard | ✓ | ✓ | 128 | | |
| Noise Reduct. | | Auto | ✓ | ✓ | 54, 128 | | |
| D2 | Bulb/Time Timer | | 8min | ✓ | ✓ | 55, 128 | |
| | Live Bulb | | Off | ✓ | — | 55, 128 | |
| | Live Time | | 0.5 sec | ✓ | — | 55, 128 | |
| | Composite Settings | | 1 sec | ✓ | — | 56, 128 | |
| Custom | | | | | | | |
| E | X-Sync. | | 1/250 | ✓ | ✓ | 129, 135 | |
| | Slow Limit | | 1/60 | ✓ | ✓ | 129, 135 | |
| | + | | Off | ✓ | ✓ | 69, 88, 129 | |
| | +WB | | WB AUTO | ✓ | — | 129 | |

| Tab | Function | Default | *1 | *2 | | | |
|---------------|----------------|----------------------|--------------------------------------|-----|---------|-------------|-----|
| | ←WB/Color | | | | | | |
| | | ← Set | ←-1 SF, ←-2 LF, ←-3 N, ←-4 MN | ✓ | ✓ | 129, 135 | |
| | | WB | Auto | ✓ | ✓ | 80, 129 | |
| | | AUTO Keep Warm Color | On | ✓ | ✓ | 129 | |
| | | Color Space | sRGB | ✓ | ✓ | 95, 129 | |
| | Record | | | | | | |
| | | File Name | Reset | ✓ | — | 130 | |
| | | Edit Filename | — | ✓ | — | 130 | |
| | | Copyright Settings | Copyright Info. | Off | ✓ | — | 130 |
| | | | Artist Name | — | — | — | |
| | Copyright Name | | — | — | — | | |
| | Utility | | | | | | |
| | | Pixel Mapping | — | — | — | 131, 155 | |
| | | Level Adjust | — | ✓ | — | 131 | |
| | | Touchscreen Settings | On | ✓ | — | 131 | |
| Sleep | | 1 min | ✓ | ✓ | 20, 131 | | |
| Certification | | — | — | — | 131 | | |

γ Setup Menu

| Tab | Function | Default | *1 | *2 | | |
|-----|--------------------------|---------------------|--------|----|-------------|-----|
| γ | Card Setup | — | — | — | 125 | |
| | | — | — | — | 22 | |
| | | English | — | — | 124, 125 | |
| | | ±0, ±0, Vivid | ✓ | — | 124 | |
| | Rec View | 0.5 sec | ✓ | — | 124 | |
| | Wi-Fi/Bluetooth Settings | Availability | On | ✓ | — | 143 |
| | | Connection Password | — | — | — | 142 |
| | | Power-off Standby | Select | ✓ | — | 138 |
| | | Reset Settings | — | — | — | 142 |
| | Firmware | — | — | — | 124 | |

Specifications

■ Camera

| | |
|--|--|
| Product type | |
| Product type | Digital camera with interchangeable Micro Four Thirds Standard lens system |
| Lens | M.Zuiko Digital, Micro Four Thirds System Lens |
| Lens mount | Micro Four Thirds mount |
| Equivalent focal length on a 35 mm film camera | Approx. twice the focal length of the lens |
| Image pickup device | |
| Product type | 4/3" Live MOS sensor |
| Total no. of pixels | Approx. 17.20 million pixels |
| No. of effective pixels | Approx. 16.05 million pixels |
| Screen size | 17.3 mm (H) × 13.0 mm (V) |
| Aspect ratio | 1.33 (4:3) |
| Live view | |
| Sensor | Uses Live MOS sensor |
| Magnification | 100% |
| Monitor | |
| Product type | 3.0" TFT color LCD, Vari-angle, touch screen |
| Total no. of pixels | Approx. 1.04 million dots (aspect ratio 3:2) |
| Shutter | |
| Product type | Computerized focal-plane shutter |
| Shutter speed | 1/4000 - 60 sec., bulb photography, time photography |
| Auto focus | |
| Product type | Hi-Speed Imager AF |
| Focusing points | 121 points |
| Selection of focusing point | Auto, Optional |
| Exposure control | |
| Metering system | TTL metering system (imager metering) Digital ESP metering/Center weighted averaging metering/Spot metering |
| Metered range | EV -2 - 20 (f/2.8 lens, ISO100) |
| Shooting modes | M : AUTO/ P : Program AE (Program shift can be performed)/ A : Aperture priority AE/ S : Shutter priority AE/ M : Manual/ Q : Movie/ ART : Art Filter/ SCN : Scene/ AP : Advanced Photo |
| ISO sensitivity | LOW, 200 - 25600 (1/3 EV step) |
| Exposure compensation | ±5.0 EV (1/3 EV step) |
| White balance | |
| Product type | Image pickup device |
| Mode setting | Auto/Preset WB (6 settings)/Customized WB/One-touch WB (camera can store up to 4 settings) |

| Recording | |
|---|---|
| Memory | SD, SDHC and SDXC |
| Recording system | Digital recording, JPEG (DCF2.0), RAW Data |
| Applicable standards | Exif 2.3, Digital Print Order Format (DPOF) |
| Sound with still pictures | Wave format |
| Movie | MPEG-4 AVC/H.264 |
| Audio | Stereo, PCM 48kHz |
| Playback | |
| Display format | Single-frame playback/Close-up playback/Index display/Calendar display/My Clips |
| Drive | |
| Drive mode | Single-frame shooting/Sequential shooting/Self-timer/Silent shooting |
| Sequential shooting | Up to approximately 8.6 fps (📷) / Up to approximately 14.1 fps (📷) |
| Self-timer | Operation time: 12 sec./2 sec./Customized |
| Energy saving function | Switch to sleep mode: 1 minute (This function can be customized.) Power OFF: 5 minutes |
| Flash | |
| Guide number | 5.4 (ISO100•m)/7.6 (ISO200•m) |
| Firing angle | Covers the angle of view of a 14 mm lens (28 mm in 35 mm format) |
| Flash control mode | TTL-AUTO (TTL pre-flash mode)/MANUAL |
| Sync speed | 1/250 s or slower |
| Wireless LAN | |
| Compatible standard | IEEE 802.11b/g/n |
| Bluetooth® | |
| Compatible standard | Bluetooth Version 4.0 |
| External connector | |
| Micro-USB connector/HDMI micro connector (type D) | |
| Power supply | |
| Battery | Lithium-ion Battery ×1 |
| Dimensions/weight | |
| Dimensions | 117.1 mm (W) × 68.0 mm (H) × 39.0 mm (D) (4.6" × 2.7" × 1.5") (excluding protrusions) |
| Weight | Approx. 380 g (0.8 lb.) (including battery and memory card) |
| Operating environment | |
| Temperature | 0 °C - 40 °C (32 °F - 104 °F) (operation)/ -20 °C - 60 °C (-4 °F - 140 °F) (storage) |
| Humidity | 30% - 90% (operation)/10% - 90% (storage) |

The terms HDMI and HDMI High-Definition Multimedia Interface, and the HDMI Logo are trademarks or registered trademarks of HDMI Licensing Administrator, Inc. in the United States and other countries.

HDMI™
HIGH-DEFINITION MULTIMEDIA INTERFACE

■ Lithium-ion battery

| | |
|-----------------------------------|--|
| MODEL NO. | BLS-50 |
| Product type | Rechargeable Lithium ion battery |
| Nominal voltage | DC 7.2 V |
| Nominal capacity | 1210 mAh |
| No. of charge and discharge times | Approx. 500 times (varies with usage conditions) |
| Ambient temperature | 0 °C - 40 °C (32 °F - 104 °F) (charging) |
| Dimensions | Approx. 35.5 mm (W) × 12.8 mm (H) × 55 mm (D) (1.4" × 0.5" × 2.2") |
| Weight | Approx. 46 g (0.1 lb.) |

■ Lithium-ion charger

| | |
|---------------------------|---|
| MODEL NO. | BCS-5 |
| Rated input | AC 100V - 240V (50/60Hz) |
| Rated output | DC 8.35V, 400mA |
| Charging time | Approx. 3 hours 30 minutes (room temperature) |
| Ambient temperature | 0 °C - 40 °C (32 °F - 104 °F) (operation)/ -20 °C - 60 °C (-4 °F - 140 °F) (storage) |
| Dimensions | Approx. 62 mm (W) × 38 mm (H) × 83 mm (D) (2.4" × 1.5" × 3.3") |
| Weight (without AC cable) | Approx. 70 g (0.15 lb.) |

- The AC cable supplied with this device is for use only with this device and should not be used with other devices. Do not use cables for other devices with this device.

- SPECIFICATIONS ARE SUBJECT TO CHANGE WITHOUT ANY NOTICE OR OBLIGATION ON THE PART OF THE MANUFACTURER.
- Visit our website for the latest specifications.

SAFETY PRECAUTIONS

**CAUTION**RISK OF ELECTRICAL SHOCK
DO NOT OPEN

CAUTION: TO REDUCE THE RISK OF ELECTRICAL SHOCK, DO NOT REMOVE COVER (OR BACK). NO USER-SERVICEABLE PARTS INSIDE. REFER SERVICING TO QUALIFIED OLYMPUS SERVICE PERSONNEL.



An exclamation mark enclosed in a triangle alerts you to important operating and maintenance instructions in the documentation provided with the product.

**WARNING**

If the product is used without observing the information given under this symbol, serious injury or death may result.

**CAUTION**

If the product is used without observing the information given under this symbol, injury may result.

**NOTICE**

If the product is used without observing the information given under this symbol, damage to the equipment may result.

WARNING!

TO AVOID THE RISK OF FIRE OR ELECTRICAL SHOCK, NEVER DISASSEMBLE, EXPOSE THIS PRODUCT TO WATER OR OPERATE IN A HIGH HUMIDITY ENVIRONMENT.

General Precautions**Read All Instructions** — Before you use the product, read all operating instructions. Save all manuals and documentation for future reference.**Power Source** — Connect this product only to the power source described on the product label.**Foreign Objects** — To avoid personal injury, never insert a metal object into the product.**Cleaning** — Always unplug this product from the wall outlet before cleaning. Use only a damp cloth for cleaning. Never use any type of liquid or aerosol cleaner, or any type of organic solvent to clean this product.**Heat** — Never use or store this product near any heat source such as a radiator, heat register, stove, or any type of equipment or appliance that generates heat, including stereo amplifiers.**Attachments** — For your safety, and to avoid damaging the product, use only accessories recommended by Olympus.**Location** — To avoid damage to the product, mount the product securely on a stable tripod, stand, or bracket.**WARNING**

- **Do not use the camera near flammable or explosive gases.**
- **Rest your eyes periodically when using the viewfinder.**

Failure to observe this precaution could result in eyestrain, nausea, or sensations similar to motion sickness. The length and frequency of the required rest varies with the individual; use your own judgement. If you feel tired or unwell, avoid using the viewfinder and if necessary consult a physician.

- **Do not use the flash and LED (including AF illuminator) on people (infants, small children, etc.) at close range.**
 - You must be at least 1 m (3 ft.) away from the faces of your subjects. Firing the flash too close to the subject's eyes could cause a momentary loss of vision.
- **Do not look at the sun or strong lights with the camera.**

- **Keep young children, infants away from the camera.**
 - Always use and store the camera out of the reach of young children and infants to prevent the following dangerous situations which could cause serious injury:
 - Becoming entangled in the camera strap, causing strangulation.
 - Accidentally swallowing the battery, cards or other small parts.
 - Accidentally firing the flash into their own eyes or those of another child.
 - Accidentally being injured by the moving parts of the camera.
- **Should you notice that the charger is emitting smoke, heat, or an unusual noise or smell, immediately cease use and unplug the charger from the power outlet, and then contact an authorized distributor or service center.**
- **Stop using the camera immediately if you notice any unusual odors, noise, or smoke around it.**
 - Never remove the batteries with bare hands, which may cause a fire or burn your hands.
- Never hold or operate the camera with wet hands.

This may cause overheating, exploding, burning, electrical shocks, or malfunctions.
- **Do not leave the camera in places where it may be subject to extremely high temperatures.**
 - Doing so may cause parts to deteriorate and, in some circumstances, cause the camera to catch fire. Do not use the charger if it is covered (such as a blanket). This could cause overheating, resulting in fire.
- **Handle the camera with care to avoid getting a low temperature burn.**
 - When the camera contains metal parts, overheating can result in a low-temperature burn. Pay attention to the following:
 - When used for a long period, the camera will get hot. If you hold on to the camera in this state, a low-temperature burn may be caused.
 - In places subject to extremely cold temperatures, the temperature of the camera's body may be lower than the environmental temperature. If possible, wear gloves when handling the camera in cold temperatures.
 - To protect the high-precision technology contained in this product, never leave the camera in the places listed below, no matter if in use or storage:
 - Places where temperatures and/or humidity are high or go through extreme changes. Direct sunlight, beaches, locked cars, or near other heat sources (stove, radiator, etc.) or humidifiers.
 - In sandy or dusty environments.
 - Near flammable items or explosives.
 - In wet places, such as bathrooms or in the rain.
 - In places prone to strong vibrations.
- The camera uses a lithium-ion battery specified by Olympus. Charge the battery with the specified charger. Do not use any other chargers.
- Never incinerate or heat batteries in microwaves, on hot plates, or in pressure vessels, etc.
- Never leave the camera on or near electromagnetic devices.

This may cause overheating, burning, or exploding.
- Do not connect terminals with any metallic objects.
- Take precautions when carrying or storing batteries to prevent them from coming into contact with any metal objects such as jewelry, pins, fasteners, keys, etc.

The short circuit may cause overheating, exploding, or burning, which burn or damage you.
- To prevent causing battery leaks or damaging their terminals, carefully follow all instructions regarding the use of batteries. Never attempt to disassemble a battery or modify it in any way, solder, etc.
- If battery fluid gets into your eyes, flush your eyes immediately with clear, cold running water and seek medical attention immediately.
- If you cannot remove the battery from the camera, contact an authorized distributor or service center. Do not try to remove the battery by force.

Damage to the battery exterior (scratches, etc.) may produce heat or an explosion.
- Always store batteries out of the reach of small children and pets. If they accidentally swallow a battery, seek medical attention immediately.
- To prevent batteries from leaking, overheating, or causing a fire or explosion, use only batteries recommended for use with this product.
- If rechargeable batteries have not been recharged within the specified time, stop charging them and do not use them.
- Do not use batteries with scratches or damage to the casing, and do not scratch the battery.

- Never subject batteries to strong shocks or continuous vibration by dropping or hitting. This may cause exploding, overheating, or burning.
- If a battery leaks, has unusual odor, becomes discolored or deformed, or becomes abnormal in any other way during operation, stop using the camera, and keep away from fire immediately.
- If a battery leaks fluid onto your clothing or skin, remove the clothing and flush the affected area with clean, running cold water immediately. If the fluid burns your skin, seek medical attention immediately.
- Never use lithium-ion batteries in a low-temperature environment. Doing so may cause generation of heat, ignition, or explosion.
- The Olympus lithium-ion battery is designed to be used only for the Olympus digital camera. Do not use the battery to other devices.
- **Do not allow children or animals/pets to handle or transport batteries (prevent dangerous behaviour such as licking, putting in mouth or chewing).**

Use Only Dedicated Rechargeable Battery and Battery Charger

We strongly recommend that you use only the genuine Olympus dedicated rechargeable battery and battery charger with this camera.

Using a non-genuine rechargeable battery and/or battery charger may result in fire or personal injury due to leakage, heating, ignition or damage to the battery. Olympus does not assume any liability for accidents or damage that may result from the use of a battery and/or battery charger that are not genuine Olympus accessories.

⚠ CAUTION

- **Do not cover the flash with a hand while firing.**
- Never store batteries where they will be exposed to direct sunlight, or subjected to high temperatures in a hot vehicle, near a heat source, etc.
- Keep batteries dry at all times.
- The battery may become hot during prolonged use. To avoid minor burns, do not remove it immediately after using the camera.
- This camera uses one Olympus lithium-ion battery. Use the specified genuine battery. There is a risk of explosion if the battery is replaced with the incorrect battery type.
- Please recycle batteries to help save our planet's resources. When you throw away dead batteries, be sure to cover their terminals and always observe local laws and regulations.

⚠ NOTICE

- **Do not use or store the camera in dusty or humid places.**
- **Use SD/SDHC/SDXC memory cards only. Never use other types of cards.** If you accidentally insert another type of card into the camera, contact an authorized distributor or service center. Do not try to remove the card by force.
- Regularly back up important data to a computer or other storage device to prevent accidental loss.
- OLYMPUS accepts no liability for any loss of data associated with this device.
- Be careful with the strap when you carry the camera. It could easily catch on stray objects and cause serious damage.
- Before transporting the camera, remove a tripod and all other non-OLYMPUS accessories.
- Never drop the camera or subject it to severe shocks or vibrations.
- When attaching the camera to or removing it from a tripod, rotate the tripod screw, not the camera.
- Do not touch electric contacts on cameras.
- Do not leave the camera pointed directly at the sun. This may cause lens or shutter curtain damage, color failure, ghosting on the image pickup device, or may possibly cause fires.
- Do not leave the viewfinder exposed to a strong light source or direct sunlight. The heat may damage the viewfinder.
- Do not push or pull severely on the lens.
- Be sure to remove any water droplets or other moisture from the product before replacing the battery or opening or closing covers.
- Before storing the camera for a long period, remove the batteries. Select a cool, dry location for storage to prevent condensation or mold from forming inside the camera. After storage, test the camera by turning it on and pressing the shutter button to make sure that it is operating normally.
- The camera may malfunction if it is used in a location where it is subject to a magnetic/ electromagnetic field, radio waves, or high voltage, such as near a TV set, microwave, video game, loud speakers, large monitor unit, TV/radio tower, or transmission towers. In such cases, turn the camera off and on again before further operation.
- Always observe the operating environment restrictions described in the camera's manual.

- Insert the battery carefully as described in the operating instructions.
- Before loading, always inspect the battery carefully for leaks, discoloration, warping, or any other abnormality.
- Always unload the battery from the camera before storing the camera for a long period.
- When storing the battery for a long period, select a cool location for storage.
- Power consumption by the camera varies depending on which functions are used.
- During the conditions described below, power is consumed continuously and the battery becomes exhausted quickly.
 - The zoom is used repeatedly.
 - The shutter button is pressed halfway repeatedly in shooting mode, activating the auto focus.
 - A picture is displayed on the monitor for an extended period of time.
- Using an exhausted battery may cause the camera to turn off without displaying the battery level warning.
- If the battery's terminals get wet or greasy, camera contact failure may result. Wipe the battery well with a dry cloth before use.
- Always charge a battery when using it for the first time, or if it has not been used for a long period.
- When operating the camera with battery power at low temperatures, try to keep the camera and spare battery as warm as possible. A battery that has run down at low temperatures may be restored after it is warmed at room temperature.
- Before going on a long trip, and especially before traveling abroad, purchase extra batteries. A recommended battery may be difficult to obtain while traveling.

Using the wireless LAN/ Bluetooth® functions

- **Turn off the camera in hospitals and other locations where medical equipment is present.**

The radio waves from the camera may adversely affect medical equipment, causing a malfunction that results in an accident. Be sure to disable wireless LAN/**Bluetooth**® functions in the vicinity of medical equipment (P. 143).

- **Turn off the camera when onboard aircraft.**

Using wireless devices onboard may hinder safe operation of the aircraft. Be sure to disable wireless LAN/**Bluetooth**® functions onboard aircraft (P. 143).

Monitor

- Do not push the monitor forcibly; otherwise the image may become vague, resulting in a playback mode failure or damage to the monitor.
- A strip of light may appear on the top/bottom of the monitor, but this is not a malfunction.
- When a subject is viewed diagonally in the camera, the edges may appear zigzagged on the monitor. This is not a malfunction; it will be less noticeable in playback mode.
- In places subject to low temperatures, the monitor may take a long time to turn on or its color may change temporarily. When using the camera in extremely cold places, it is a good idea to occasionally place it in a warm place. The monitor exhibiting poor performance due to low temperatures will recover in normal temperatures.
- The monitor of this product is manufactured with high-quality accuracy, however, there may be a stuck or dead pixel on the monitor. These pixels do not have any influence on the image to be saved. Because of the characteristics, the unevenness of the color or brightness may also be found depending on the angle, but this is due to the structure of the monitor. This is not a malfunction.

Legal and Other Notices

- Olympus makes no representations or warranties regarding any damages, or benefit expected by using this unit lawfully, or any request from a third person, which are caused by the inappropriate use of this product.
- Olympus makes no representations or warranties regarding any damages or any benefit expected by using this unit lawfully which are caused by erasing picture data.

Disclaimer of Warranty

- Olympus makes no representations or warranties, either expressed or implied, by or concerning any content of these written materials or software, and in no event shall be liable for any implied warranty of merchantability or fitness for any particular purpose or for any consequential, incidental or indirect damages (including but not limited to damages for loss of business profits, business interruption and loss of business information) arising from the use or inability to use these written materials or software or equipment. Some countries do not allow the exclusion or limitation of liability for consequential or incidental damages or of the implied warranty, so the above limitations may not apply to you.
- Olympus reserves all rights to this manual.

Warning

Unauthorized photographing or use of copyrighted material may violate applicable copyright laws. Olympus assumes no responsibility for unauthorized photographing, use or other acts that infringe upon the rights of copyright owners.

Copyright Notice

All rights reserved. No part of these written materials or this software may be reproduced or used in any form or by any means, electronic or mechanical, including photocopying and recording or the use of any type of information storage and retrieval system, without the prior written permission of Olympus. No liability is assumed with respect to the use of the information contained in these written materials or software, or for damages resulting from the use of the information contained therein. Olympus reserves the right to alter the features and contents of this publication or software without obligation or advance notice.

Trademarks

- Microsoft and Windows are registered trademarks of Microsoft Corporation.
- Mac, OS X, and macOS are trademarks of Apple Inc.
- SDXC Logo is a trademark of SD-3C, LLC.
- Apical logo is a registered trademark of Apical Limited.
- Micro Four Thirds, Four Thirds, and the Micro Four Thirds and Four Thirds logos are trademarks or registered trademarks of the OLYMPUS CORPORATION in Japan, the United States, the countries of the European Union, and other countries.
- Wi-Fi is a registered trademark of the Wi-Fi Alliance.
- The Wi-Fi CERTIFIED logo is a certification mark of the Wi-Fi Alliance.
- The **Bluetooth**® word mark and logos are registered trademarks owned by the Bluetooth SIG, Inc. and any use of such marks by OLYMPUS CORPORATION is under license.
- The standards for camera file systems referred to in this manual are the "Design Rule for Camera File System/DCF" standards stipulated by the Japan Electronics and Information Technology Industries Association (JEITA).
- All other company and product names are registered trademarks and/or trademarks of their respective owners.



THIS PRODUCT IS LICENSED UNDER THE AVC PATENT PORTFOLIO LICENSE FOR THE PERSONAL AND NONCOMMERCIAL USE OF A CONSUMER TO (i) ENCODE VIDEO IN COMPLIANCE WITH THE AVC STANDARD ("AVC VIDEO") AND/OR (ii) DECODE AVC VIDEO THAT WAS ENCODED BY A CONSUMER ENGAGED IN A PERSONAL AND NON-COMMERCIAL ACTIVITY AND/OR WAS OBTAINED FROM A VIDEO PROVIDER LICENSED TO PROVIDE AVC VIDEO. NO LICENSE IS GRANTED OR SHALL BE IMPLIED FOR ANY OTHER USE. ADDITIONAL INFORMATION MAY BE OBTAINED FROM MPEG LA, L.L.C. SEE [HTTP://WWW.MPEGLA.COM](http://www.MPEGLA.COM)

The software in this camera may include third party software. Any third party software is subject to the terms and conditions, imposed by the owners or licensors of that software, under which software is provided to you.

Those terms and other third party software notices, if any, may be found in the software notice PDF file stored at <http://www.olympus.co.jp/en/support/imsig/digicamera/download/notice/notice.cfm>

Numbers

| | |
|--------------------------------------|---------------|
| (Beep sound) | 127 |
| (Protect) | 105 |
| Slow Limit..... | 129, 135 |
| +WB | 129 |
| X-Sync | 129, 135 |
| RC Mode..... | 150 |
| (Close-up playback) | 103 |
| (Monitor brightness adjustment)..... | 124 |
| (Index display)..... | 103, 111, 133 |
| /Info Settings | 127, 132 |
| + | 129 |
| /..... | 74 |
| (Single-frame erase) | 105 |
| (language)..... | 124 |
| (One-touch white balance)..... | 81, 98 |
| (Image selection)..... | 106 |
| (Face priority AF) | 71 |
| (Image rotation)..... | 120 |
| Keep Warm Color | 129 |
| (Preview)..... | 98 |
| (Sequential Low) | 74 |
| (Sequential High) | 74 |
| Info | 127 |
| Settings | 127 |
| Control Settings..... | 127 |
| (Shortcut) Button..... | 30 |
| (Movie) button | 58, 97, 126 |
| (Share Order)..... | 106 |

A

| | |
|---|--------------|
| A (Aperture priority mode) | 52 |
| AdobeRGB | 95 |
| Advanced photo mode..... | 37 |
| AE Bracketing..... | 45 |
| AEL/AFL | 131 |
| AE lock | 98, 126, 131 |
| AF Area..... | 70 |
| AF illuminator..... | 28, 115 |

| | |
|------------------------------|-----|
| AF Mode | 81 |
| Movie | 119 |
| AF target settings | 70 |
| AF tracking | 82 |
| AP Mode..... | 37 |
| ART (Art filter)..... | 47 |
| Art fade..... | 61 |
| Aspect ratio..... | 83 |
| Audio recording | |
| Still image | 108 |
| AUTO mode () | 31 |

B

| | |
|------------------------|---------|
| Backlight HDR | 35 |
| Battery charge | 15 |
| Battery level..... | 20 |
| Beep sound | 127 |
| BGM | 65, 104 |
| Bleach Bypass..... | 49 |
| Bluetooth | 136 |
| BULB | 55 |
| Bulb photography | 55 |
| Bulb/Time Timer | 128 |
| Button Function | 97 |

C

| | |
|----------------------------|---------------|
| C-AF (Continuous AF) | 81 |
| C-AF+TR (AF tracking)..... | 82 |
| Calendar display..... | 103, 111, 133 |
| Card..... | 17, 147 |
| Card Setup | 125 |
| Certification..... | 131 |
| Clips..... | 63 |
| Close-up playback | 103 |
| Color Filter | 93 |
| Color Space..... | 95, 129 |
| Composite Settings | 128 |
| Compression rate | 83, 135, 147 |
| Connection | |
| Computer..... | 144 |
| Smartphone | 136 |

| | |
|--------------------------|----------|
| Continuous AF | 81 |
| Contrast | 92 |
| Control Settings | 127 |
| Copyright Settings | 130 |
| Custom Menu | 126, 163 |

D

| | |
|------------------------------|---------|
| Date/time setting (🕒) | 21 |
| Dial Function | 126 |
| Digital Tele-converter | 69, 115 |
| Displayed Grid | 127 |
| DPOF | 107 |

E

| | |
|-----------------------------|-----|
| Edit Filename | 130 |
| Effect (i-Enhance) | 94 |
| Elec. Zoom Speed | |
| Movie | 119 |
| Still image | 116 |
| Erase | |
| All images | 125 |
| Selected images | 106 |
| Single-frame | 105 |
| Exif data | 130 |
| Exposure compensation | 69 |
| Exposure Shift | 128 |
| External flash units | 149 |
| Eye priority AF | 71 |

F

| | |
|-------------------------------|-----|
| Face priority AF | 71 |
| File format | 147 |
| File Name | 130 |
| File size | 147 |
| Fine-Tune | 50 |
| Firmware | 124 |
| Flash | 72 |
| Flash intensity control | 88 |
| Flicker reduction | 127 |
| Fn button | 97 |
| Focus Bracketing | 46 |
| Focus mode | 81 |
| Focus ring | 81 |
| Format | 125 |

G

| | |
|-----------------|-----|
| GPS log | 141 |
| Gradation | 93 |

H

| | |
|--------------------------------|----------|
| HDMI | 127, 134 |
| HDR | 41 |
| Highlight&Shadow Control | 96 |
| Histogram display | 26 |

I

| | |
|------------------------------------|-------------------|
| Image aspect | 83 |
| Image Overlay | 122 |
| Image quality | |
| Movie (📹 ⏪) | 84 |
| Still image (📷 ⏪) | 83 |
| Image quality settings | |
| Movie | 84 |
| Still image | 83, 129, 135, 147 |
| Image selection | 106 |
| Image size | |
| Movie | 84 |
| Still image | 129, 135, 147 |
| Image Stabilizer | 89 |
| Movie | 119 |
| Image transfer to smartphone | 140 |
| Index display | 103, 111, 133 |
| INFO button | 26, 101, 113 |
| Information display | 24 |
| Playback | 100 |
| In-movie image capture | 122 |
| Installation | 145 |
| Instant Film | 49 |
| Interchangeable lenses | 148 |
| ISO-Auto Set | 128 |
| ISO sensitivity | 79 |

J

| | |
|-----------------|-----|
| JPEG Edit | 121 |
|-----------------|-----|

K

| | |
|-----------------------------|----|
| Keystone Compensation | 44 |
|-----------------------------|----|

L

| | |
|---|----------|
| Language setting ()..... | 124 |
| Level Adjust | 131 |
| Level gauge | 26 |
| Light Trails | 34 |
| Live Bulb..... | 128 |
| Live composite photography..... | 38, 56 |
| Live control | 76 |
| Live guide | 31 |
| LIVE TIME | 39, 55 |
| Live View Boost..... | 127 |
| Long time exposure (BULB/LIVE TIME) | 55 |
| LV-Info | 127, 132 |
| LV super control panel..... | 77 |

M

| | |
|---|----------|
| M (Manual mode)..... | 54 |
| Manual focus | 81 |
| Menu..... | 113, 162 |
| Metering..... | 91 |
| MF Assist..... | 126, 132 |
| MF (Button Function)..... | 98 |
| MF (Manual focus)..... | 81 |
| Mode dial | 27 |
| Monitor brightness adjustment | 124 |
| Monochrome Color | 94 |
| Movie  | 119 |
| Movie Effects | 61 |
| Movie mode | 60, 87 |
| Movie shooting | 58 |
| Movie Tele-converter | 61 |
| Multi echo | 61 |
| Multiple Exposure | 40 |
| My Clips..... | 63, 109 |

N

| | |
|---|-----|
| Noise Filter | 128 |
| Noise Reduct | 128 |
| Number of storable still pictures | 147 |

O

| | |
|--|--------|
| OI.Palette..... | 136 |
| OI.Share | 136 |
| OI.Track..... | 136 |
| Old film | 61 |
| Olympus Workspace | 145 |
| One shot echo | 61 |
| One-touch white balance ()..... | 81, 98 |

P

| | |
|--|----------|
| P (Program mode) | 51 |
| Panorama | 43, 110 |
| Partial Color..... | 50 |
| PC software | 145 |
| Peaking..... | 98, 132 |
| Peaking Color | 127 |
| Picture Mode | 78, 115 |
| Pixel Count | 135, 147 |
| Pixel mapping | 131, 155 |
| Playback Movie | 102, 105 |
| Still image | 102, 103 |
| Playback Menu | 120, 163 |
| Position information | 141 |
| Preview ()..... | 98 |
| Program shift (Ps)..... | 51 |
| Protect | 105 |
| Protect reset | 123 |

R

| | |
|---|----------|
| Radio-Controlled Flash Photography | 149 |
| RAW Data Edit | 120 |
| RAW image | 83 |
| RC Mode ( RC Mode)..... | 150 |
| Recording Volume | 119 |
| Rec View | 124 |
| Registration | 145 |
| Remote shooting | 141 |
| Reset | 114 |
| Reset Lens | 126 |
| Rotation | 103, 120 |

S

| | |
|--|------------|
| S (Shutter priority mode)..... | 53 |
| S-AF+MF (Single AF and Manual focus)..... | 82 |
| S-AF (Single AF)..... | 81 |
| Saturation | 92 |
| SCN (Scene)..... | 33 |
| SD card..... | 147 |
| Formatting the card..... | 125 |
| Self-portraits | 67 |
| Self-timer | 74 |
| Sequential shooting..... | 74 |
| Setup Menu | 124, 165 |
| Share Order..... | 106 |
| Sharpness | 91 |
| Shooting Menu | 114, 162 |
| Shooting Menu 1..... | 114 |
| Shooting Menu 2..... | 114 |
| Shooting modes..... | 27 |
| Silent [♥]..... | 35, 42, 75 |
| Silent [♥] Settings..... | 117 |
| Single AF | 81 |
| Sleep | 20, 131 |
| Slideshow | 104 |
| Slow-motion movie | 66 |
| sRGB..... | 95 |
| Storage..... | 144 |
| Super Spot AF | 99 |

T

| | |
|-------------------------------|---------|
| Time Lapse Movie | 116 |
| Time lapse shooting | 116 |
| Time photography..... | 55 |
| Touch screen operations | 57, 111 |
| Touchscreen Settings | 131 |
| Trimming | |
| JPEG image..... | 121 |
| Movie | 123 |
| TV | 134 |

U

| | |
|---------------------|-----|
| USB connection..... | 144 |
| USB Mode | 127 |

V

| | |
|------------------------|----------|
| Video Bit Rate..... | 84, 119 |
| Video Frame Rate | 84, 119 |
| Video Menu | 119, 163 |
| Volume adjustment..... | 105 |

W

| | |
|------------------------------------|--------------------|
| WB..... | 129 |
| White balance..... | 80 |
| White balance compensation | 90 |
| Wi-Fi/Bluetooth Settings | |
| | 124, 138, 142, 143 |
| Wireless Remote Control Flash..... | 150 |

Z

| | |
|--------------------|----|
| Zoom frame AF..... | 99 |
|--------------------|----|

OLYMPUS KOREA CO., LTD.

2F-3F Majestar City 1, 12, Seocho-daero 38-gil, Seocho-gu, Seoul,
06655, Republic of Korea
Tel. 1544-3200
E-mail: hotline.okr@olympus-ap.com
<http://www.olympus.co.kr>

OLYMPUS (MALAYSIA) Sdn Bhd

512, 5th Floor, Block D, Kelana Square 17, Jalan SS 7/26, Kelana Jaya,
47301 Petaling Jaya, Selangor, Malaysia
Tel: (603) 7806 2173
Fax: (603) 7803 7164
E-mail: service.oml@olympus-ap.com
<http://www.olympus.com.my>

OLYMPUS (Thailand) CO., LTD.

23/112 Sorachai Building, 27th Floor, Soi Sukhumvit 63 (Ekamai)
Sukhumvit road Klongton Nua, Wattana, Bangkok 10110 Thailand
Tel: (66) 2-000-7700
E-mail: imaging.oth@olympus-ap.com

OLYMPUS AMERICA INC.

3500 Corporate Parkway, P.O. Box 610, Center Valley, PA 18034-0610, U.S.A. Tel. 484-896-5000

Technical Support (U.S.A. / Canada)

24/7 online automated help:
<http://www.olympusamerica.com/support>
Phone customer support:
Tel. 1-800-260-1625 (Toll-free)

Our phone customer support is available from
9 am to 9 pm (Monday to Friday) ET
<http://olympusamerica.com/contactus>
Olympus software updates can be obtained at:
<http://www.olympusamerica.com/digital>

OLYMPUS EUROPA SE & CO. KG

Premises: Consumer Product Division
Wendenstrasse 14-18, 20097
Hamburg, Germany
Tel: +49 40-23 77 3-0 / Fax: +49 40-23 07 61

Goods delivery: Modul H, Willi-Bleicher Str. 36,
52353 Düren, Germany
Mailing address: Postfach 10 49 08,
20034 Hamburg, Germany

European Technical Customer Support:

Please visit our homepage <http://www.olympus-europa.com> or call our TOLL FREE NUMBER* :
00800 - 67 10 83 00

for Austria, Belgium, Denmark, Finland, France, Germany, Luxemburg, Netherlands, Norway,
Poland, Portugal, Spain, Sweden, Switzerland, United Kingdom.

810-800 67 10 83 00 for Russia
800 167 777 for Czech Republic

* Please note some phone service providers do not permit access to 00800 numbers or require
an additional prefix. Charges may apply here. Please contact your service provider directly for
more details.

For all not listed European Countries and in case that you can't get connected to the above mentioned number,
please make use of the following CHARGED NUMBERS **+49 40 - 237 73 899**

OLYMPUS (BEIJING) SALES & SERVICE CO.,LTD

Customer Support: 400-650-0303 Homepage: <http://olympus-imaging.cn>

Customer Service Center:

10F, K, Wah Centre, 1010 Huaihai Road(M), Xuhui District, Shanghai
Zip: 200031

OLYMPUS HONG KONG AND CHINA LIMITED

Digital Camera Repair Centre
L4207, Office Tower, Langham Place, 8 Argyle Street, Mongkok, Kowloon, Hong Kong
Customer Hotline: +852-2376-2150 Fax: +852-2375-0630
E-mail: cs.ohc@olympus-ap.com
<http://www.olympus.com.hk>